

Sandec: Department of
Sanitation, Water and Solid
Waste for Development

Black Soldier Fly Biowaste Processing

A Step-by-Step Guide – 2nd Edition



eawag
aquatic research 

Impressum

Publisher:	Eawag – Swiss Federal Institute of Aquatic Science and Technology Department of Sanitation, Water and Solid Waste for Development (Sandec) Überlandstrasse 133, 8600 Dübendorf, Switzerland Phone +41 58 765 52 86
Cover picture:	Sirajuddin Kurniawan
Photos:	Eawag (unless stated otherwise)
Layout:	Leanza Mediaproduktion GmbH
Figures:	Stefan Diener, Eawag
Review:	Moritz Gold
Published:	2021
Circulation:	200 copies printed on original recycled paper
ISBN:	978-3-906484-75-4
Bibliographic reference:	Dortmans B.M.A., Egger J., Diener S., Zurbrügg C. (2021) Black Soldier Fly Biowaste Processing - A Step-by-Step Guide, 2 nd Edition Eawag: Swiss Federal Institute of Aquatic Science and Technology, Dübendorf, Switzerland



The content of this document is licensed under a Creative Commons Attribution 4.0 International license



Black Soldier Fly Biowaste Processing

A Step-by-Step Guide — 2nd Edition

Bram Dortmans
Julia Egger
Stefan Diener
Christian Zurbrügg

Written and published with financial support from the Swiss State Secretariat for Economic Affairs (SECO) and the Swiss Re Foundation



Schweizerische Eidgenossenschaft
Confédération suisse
Confederazione Svizzera
Confederaziun svizra

Swiss Confederation

Federal Department of Economic Affairs,
Education and Research EAER
State Secretariat for Economic Affairs SECO



Swiss Re
Foundation



Table of contents:

Glossary	IV
Chapter 1: Rationale	1
1.1 General introduction	1
1.2 Scope and target audience	2
1.3 Navigating through this guide	3
Chapter 2: Introduction into BSF biowaste processing	5
2.1 The Black Soldier Fly	5
2.2 Why the Black Soldier Fly?	7
2.3 Engineering the BSF life cycle	8
2.4 Safety and hygiene measures when working with BSF and biowaste	9
Chapter 3: The BSF rearing process	11
3.1 Rearing BSF in a controlled environment	11
3.2 Activities in the BSF rearing unit	16
3.3 Work scheduling and data management	36
Chapter 4: BSFL conversion operations	39
4.1 Sourcing biowaste	39
4.2 Activities in the BSFL conversion unit	45
4.3 Work schedules, monitoring and data collection	59
Chapter 5: BSFL post-processing and marketing	61
5.1 Marketable products from BSFL biowaste conversion	61
5.2 Activities in the post-processing unit	67
5.3 Monitoring, storage and product labelling	84
Chapter 6: Business development	87
6.1 Cost-revenue analysis and financial viability	87
6.2 The scenario-based business model tool	88
6.3 The web-based cost model tool	90
6.4 Siting a BSF waste processing facility	90
6.5 Creating a floorplan and planning the unit locations for a BSF site	91
6.6 Operational scenarios and work scheduling	92
Annexes	97
Annex A: Work schedule for rearing unit	98
Annex B: Feeding schedule for nursery larvero	101
Annex C: Work schedule for conversion unit	102
Annex D: Log sheet for productivity parameters in rearing unit	106
Annex E: Log sheet for productivity parameters in treatment step of conversion unit	108
Annex F: Log sheet for productivity parameters in pre-processing and harvesting stage of conversion unit	110
Annex G: Log sheet for productivity parameters in post-processing unit	112
Annex H: Technical drawings for custom-made materials and equipment	114
Annex I: Material requirement list for three scenarios of operation in a BSF biowaste processing facility	124

Glossary

5-DOI:	Abbreviation for Five-Day-Old-Larvae. Keeping the hatchlings in a controlled and protected environment for five days after hatching increases the survival rate and allows the larvae to be counted before they are added to the biowaste.
Adult:	The final development stage after pupation. With insects, this is usually called “imago”.
Amino acids:	Amino acids are the building blocks of proteins and therefore determine their quality. The amino acid profile of BSF meal is important to consider for feed formulations for animals.
Anaerobic digestion:	Degradation of organic compounds by microorganisms in the absence of oxygen, leading to the production of biogas.
Ant trap:	Protects from ant invasion. Each table leg is placed into a container filled with water and a drop of detergent. The detergent reduces the surface tension of the water.
Attractant:	Smelly liquid substance that attracts BSF females to lay eggs nearby. Usually, this contains different smelly substances like fermenting fruit, dead flies or residue. BSF eggs have also been found to act as an attractant. It is, therefore, advisable not to harvest eggs every day as the already laid eggs attract other females.
Batch operation:	In batch operation, a defined amount of waste and larvae are added to a container, which is harvested after a certain time. Batch operation is in contrast to continuous operation, where waste and larvae are added continuously to the same container. A continuous container is only emptied once it is full.
BCR:	Biomass Conversion Rate is the fraction of biowaste which is converted into larval biomass.
Biowaste:	Generally, all biodegradable matter. In this particular context, it does not include waste high in cellulose (e.g. garden waste, wood, grass clippings, leaves, etc.) as this cannot be easily digested by the larvae.
Blanching:	Blanching describes the process of dipping the larvae shortly in boiling water and subsequently washing them with clean and cold water.
BSF:	Black Soldier Fly, <i>Hermetia illucens</i>
BSFL:	The larvae of the Black Soldier Fly
Conditioning:	Preparation of the harvested BSFL for selling in live form or further post-processing. Conditioning of the larvae is a requirement to increase product purity and quality.
Cocopeat:	The powdery material resulting from processing coconut fibre. In this context, it is mostly used for its moisture absorbing properties. It can be replaced by other materials with similar moisture absorbing properties, such as wheat bran, for example.
Compost:	Organic matter that has been degraded and transformed by aerobic processes to a soil-like substance and can be used as a fertilizer and soil amendment.
Crude oil:	Fat fraction that results from pressing dried larvae with a screw press. It is called “crude” because besides the fat also contains solids, which mainly consist of proteins and fibres.
Dark cage:	Adult flies emerge in the dark cage where they remain until transferred to the love cage. The darkness keeps the flies calm and prevents mating activity.

Date code:	The date code allows for calculating the duration of the ongoing process and is applied to cages and containers. It consists of the calendar week of the year and the day of the week (for example: Tuesday of week 8 is coded as 8.2).
Decanting:	Process to purify BSF crude oil. Gradual pouring of separated BSF oil from one container into another without disturbing the settled solids.
Desiccant:	A substance that is absorbing water and thereby sustains a state of dryness.
Dry matter:	The mass of the matter after all water has been removed. It is usually determined by keeping a sample in an oven at 105°C for at least 12 hours.
Egg:	A female fly lays around 500 eggs from which young larvae will hatch within four days. One egg weighs about 29µg.
Eggie:	The media used in an engineered BSF-system to collect eggs. It provides sheltered cavities for egg deposition.
Engineered biosystem:	A biological process that has been optimised for a practical use.
Expiry date:	A previously set date after which the product should no longer be used.
Fatty acids:	Major components of oil. The fatty acid composition determines the quality and application of BSF oil.
Feeding station:	A designated area where waste is added to the larveros. It is advisable that it can be cleaned easily (tiled or sealed floor) as biowaste may be spilled during the feeding operation.
Fishmeal:	Fishmeal is a nutrient-rich feed ingredient used in the diets of farmed animals. It is manufactured from wild-caught small marine fish and is a powder obtained after grinding, cooking and defatting the fish. Fishmeal production is a significant contributor to over-fishing.
Food and restaurant waste:	Biowaste from restaurants consists of kitchen scraps and food waste. It typically has a higher nutritional value and a lower water content than market waste or food processing waste.
Food processing waste:	Biowaste from the food processing industry. It varies from fruit and vegetable bits to bread crumbs and/or dairy products. It is usually a homogenous and uniform waste source.
Fractioning:	Process in which BSFL are split into a protein fraction (BSF meal) and a fat fraction (BSF oil).
Frass/Residue:	The leftovers after the treatment process. This substance can be a crumbly, soil-like substrate or a wet slurry. It requires a subsequent composting step to stabilize, before it can be used as solid amendment and/or fertilizer.
Hammer mill:	Crushes and shreds material into smaller pieces by repeated strikes of small hammers. It does not cut material. The particle size is defined by the diameter of the outlet screen.
Hatching:	The process of young larvae (hatchlings) emerging from the egg.
Hatchling:	Larvae that have just hatched from the eggs. Sometimes also called "neonates".
Hatchling container:	Hatchlings fall into the hatchling container after hatching where they remain and feed for five days on nutritious feed (chicken feed) to become 5-DOL.
Hatchling shower:	Harvested eggies are placed on a rack called a hatchling shower, which is placed over a hatchling container. When young larvae hatch, they fall into the hatchling container, which is replaced regularly (every one to three days).

Incubator unit:	Container for first phase of BSFL conversion stage (from 5-DOL to 8-DOL).
Instar:	A phase of larval growth. The BSFL pass through 5 instars before reaching the final instar which is the pre-pupae stage.
Lab oven:	An oven which provides a uniform temperature. In BSF biowaste processing, it is mostly used to obtain dry matter samples from waste, residue and larvae, and operates at 105°C.
Larva:	The juvenile stadium of holometabolous insects. There are six larval stages, so-called instars, in the life cycle of the Black Soldier Fly before metamorphosis (transforming into an adult fly).
Larvero:	The larvero is the container where larvae feed on biowaste after being transferred from the incubator unit. The larvae stay here from 8-DOL up to 17-DOL when they are harvested.
Love cage:	The love cage is a netted enclosure with a cohort of same-aged flies received from the dark cages. In the love cage, adult flies mate and females lay their eggs into eggies. After a week, the love cage is removed and emptied.
Low- and middle-income setting:	Although BSF biowaste treatment can be applied all around the globe, the set-up and operation presented in this book focuses on low- and middle-income countries (GNI up to 10,000 EUR). This context is characterized by low labour costs, and a high organic fraction of the municipal solid waste.
Market waste:	Consists mostly of fruits and vegetables. It has a high water content (up to 95%) and is subject to seasonal variation. The outer parts of leafy vegetables may have been exposed to pesticides.
Municipal organic waste:	The organic fraction of waste generated by settlements, which includes households, commercial and industrial premises, institutions (schools, health care centres, prisons, etc.) and public spaces (streets, bus stops, parks and gardens).
Net present value (NPV):	It is the difference between current amount of cash inflows and the current amount of cash outflows over a period of time. In this guide the NPV was calculated over a period of five years
Nursery container:	In the nursery container, 5-DOL are fed a defined amount of nutritious feed (e.g. wet chicken feed) until they transform into pre-pupae. They are transferred to the pupation containers where the pre-pupae pupate and eventually emerge as adults to maintain the colony.
Pop-larvae:	One type of dried BSFL, which have a puffed shape and a crispy texture. Microwave drying or roasting results in pop-larvae.
Post-processing:	Includes all processes to convert sanitised larvae into products like dried BSFL, BSF meal and BSF oil.
Poultry manure:	Manure from broiler production or layer hens. BSF larvae grow well on this rather homogenous biowaste, but tend to remain quite small.
Pre-pupa:	The last larval stage that crawls out of the waste to search a dry pupation site. In comparison to the larvae, pre-pupae have a higher chitin content and are, therefore, less easy for fish and chicken to digest.
Press cake:	Solid protein fraction after pressing BSFL using a screw press.
Press liquid:	Liquid fat fraction after pressing BSFL using a screw press.
Pupa:	During pupation, the metamorphosis from larva to adult fly happens. Black Soldier Fly larvae pupate within their last larval skin and pupation lasts around 20 days.

Pupation container:	The pupation container is filled with a moist pupation substrate (e.g. compost, moist coco peat, pot soil, etc.) into which pre-pupae bury to pupate.
Purging:	Process to condition larvae before selling them alive. Larvae are washed with clean water and then left in dry cocopeat for a few hours.
Rearing:	The rearing facility contains the whole life cycle of the Black Soldier Fly and produces the 5-DOL in sufficient numbers to treat the incoming biowaste.
Residue/Frass:	See "Frass".
Sanitising:	Process to condition larvae before processing them into products. Larvae are killed rapidly by dipping them in boiling water for 60 seconds and are then cleaned with cold and clean water.
Shaking sieve:	A sieve which vibrates or shakes, that is powered by an eccentric drive. It is used with two layer meshes of 3 and 7 mm in size during harvest to separate grown larvae from the residue.
Shelf life:	Is the length of time that a BSFL product may be used before its quality decreases.
Slaughterhouse waste:	It includes bones, organs, hooves, blood and other inedible animal parts leftover after all the edible parts of the animal have been removed. It can also include the gut content of the slaughtered animals.
Spent grains:	The main waste product from beer production. The leftover malt and adjuncts after the mash has extracted most of the sugars, proteins, and nutrients.
Substrate:	The material made up of various biowaste streams after pre-processing and conditioning which is fed to the BSFL
Transfer container:	Collects the pre-pupae which crawl out of the nursery container. It contains cocopeat or another dry substance to prevent the pre-pupae from escaping.
TS:	Total solids. It is the dry matter portion of a material. It normally relates to analysing the water content of a material (see "Dry matter").
Ventilation frame:	Provides a space between the layers of larveros. It ensures the exchange of air and, thus, the removal of moisture from the larveros
Waste reduction:	The waste reduction is measured, either based on wet weight or dry weight, and compares the biowaste going into the treatment with the remaining biomass (residue). Depending on the type of biowaste, one can expect a waste reduction between 60% and 85% dry weight
Waste sourcing:	Proper waste sourcing is of crucial importance for a complete waste treatment chain. It relies on a well-organised waste collection scheme that takes into account efficient collection routes and adequate means of transport.
Water activity:	Is a measure for free water in a product that is available for microorganisms. Water activity lower than 0.6 inhibits growth of any bacteria and yeasts.
Water content:	When a sample (substrate, larvae, residue, etc.) is dried at 105°C in a lab oven, all the water that is evaporated is referred to as "water content". Together with the remaining solids ("total solids"), both are expressed as percentages of wet weight; it equals to 100%



Chapter 1:

Rationale

1.1 General introduction

Urban solid waste management is considered one of the most immediate and serious environmental problems confronting urban governments in low- and middle-income countries. The severity of this challenge will increase in the future given the trends of rapid urbanisation and growth in urban population. Due to growing public pressure and environmental concerns, waste experts worldwide are being called upon to develop more sustainable methods of dealing with municipal waste that embrace the concept of a circular economy.

Recycling organic waste material (biowaste) is still fairly limited, especially in low- and middle-income settings, although this is by far the largest fraction of all generated municipal waste. This book deals with urban organic municipal waste from households, commercial activities, and institutions. It describes the conversion of biowaste by insect larvae, using the example of the Black Soldier Fly (BSF), *Hermetia illucens*, an approach that has obtained much attention in the past decade. The feeding activity of the larvae drastically reduces the amount of waste while the harvested larvae can be used as valuable raw materials in the animal feed industry. This technology has received attention in recent years due to the business opportunities it offers, which simultaneously address several challenges of modern society: hygiene issues arising from the lack of waste management, unemployment in urban areas, and an increased demand for sustainable feed for the ever-growing aquaculture and aviculture sector. Enterprises and small entrepreneurs are already investing significant amounts of money and time into this technology and are interested in keeping a competitive edge on the practical aspects of operating such a facility in a cost-effective way. Although academic publications on BSF are on the increase, the business interest and perceived need to maintain a competitive edge has hindered open exchange about and discussion of the practical day-to-day working steps required to operate such a facility. Filling this gap is the main objective of this publication.

This document is based largely on the experience of a treatment facility in Indonesia with the capacity to treat two tons of waste per day that has been in operation for over five years and the insights from an experimental facility in Sweden. Waste processed at the facility in Indonesia was mostly fruit and vegetable waste from a wholesale market. Upscaling or transferring this information to a larger facility might require some adaptation or adjustment of equipment. It is, however, our opinion that the standard procedures described are valid for a large range of scaling-up.

Two research projects provided the basis for the writing of the second edition of these guidelines. FORWARD is a project located in Indonesia funded by the Swiss State Secretariat for Economic Affairs (SECO), under a framework agreement with the Indonesian Ministry of Public Works & Housing (PU-PeRa). It works in close collaboration with national and local governmental authorities, with Indonesian researchers and with selected private enterprises to advance and mainstream implementation of BSF waste processing. SIBRE is a research project funded by SwissRe Foundation with the objective to generate knowledge and tools around BSF waste processing for use by small and medium enterprises and municipalities. Its focus was set predominantly on the economic perspectives and developing standard protocols for products derived from BSF larvae and testing these in the Indonesia context. In addition, this second edition benefited significantly from the close collaboration with ETH-Zürich and the Department of Health Sciences and Technology through the research group of Prof. A. Mathys on Sustainable Food Processing with whom we collaborate on a variety of research projects on BSF waste processing.

This manual was written as open source with the ambition that BSF waste processing would obtain widespread notice, implementation and replication. In this spirit, the authors would like

to acknowledge all those that helped to develop, document and discuss the practical aspects of BSF rearing and waste treatment by larvae. Particular thanks go to Sirajuddin Kurniawan, whose pictures of the equipment and work steps saved us many pages of explanatory text, Bart Verstoppen for his contribution to the first edition of this book, Maximilian Grau and Grégoire Virard for their intense work on the cost modelling, Alexander Mathys, Moritz Gold and Daniela Peguero of ETH-Zürich for our most inspiring and fruitful research collaboration, Cecilia Lalander and Björn Vinnerås of the Swedish Agricultural University SLU (Sweden) for an excellent research partnership, Tina Kusumawardhani and Teguh Rahayu for translating this book into Bahasa Indonesia and all their help in developing the rearing system, Longyu Zheng and Jibin Zhang of the Huazhong Agricultural University (China) and Michael Wu of JM Green (China) for their openness and their fruitful input, and finally also Waste 4 Change and Puspa Agro for their partnership and willingness to manage and host the BSF facility.

1.2 Scope and target audience

An engineered BSF processing facility can be designed and operated to achieve certain target objectives based on the natural life cycle of BSF. These, for instance, can be to cost effectively augment larvae quality or maximize the larval mass produced within a certain time frame or based on a particular feedstock, similar to a typical livestock rearing system (chicken, beef, etc.).

In this manual, however, we follow a waste management perspective. In other words, we start from the premise that biowaste is the substance of concern for which we suggest to use the BSF treatment technology as a suitable processing and recycling solution to produce larvae and waste residue.

The primary goal, therefore, is to process biowaste in an efficient way with regard to investment and operational costs, as well as space requirements. By processing biowaste, threats to public health and the environment can be reduced.

The technology solution consists of feeding segregated biowaste to BSF larvae, which have been reared in a nursery. Larvae grow on the waste feedstock and reduce the waste mass. At the end of the process, larvae are harvested and, if necessary, post-processed into a suitable animal feed product. The waste residue can also be further processed and potentially sold or used as soil amendment with fertilizing properties.

This guide has been prepared for practical use. It explains the required materials and equipment, as well as each working step, similar to a cookbook with its respective recipes. **It includes all information required to develop and operate a medium-sized Black Soldier Fly larvae waste processing facility, able to treat 5 tons of waste per day.** The book also contains other scenarios of scale in which the amount of work is less. Work plans and instructions for these scenarios are available via web links.

It is worth mentioning that the approach presented in this handbook is one among many. It is based on locally available equipment and limited automation. The operations presented here have proven to work, but selected steps may individually be replaced with other procedures depending on the given context or experience.

Given the approach of this handbook, it targets readers with little or only some basic knowledge of waste management in general and Black Soldier Fly technology in particular, who have the willingness to work with waste and to implement and operate such a facility. This guidance can also be helpful to someone who has already started with BSF treatment and is interested in obtaining other viewpoints on how things could be done.

1.3 Navigating through this guide

The manual is structured according to the three main processing units that are key to a BSF processing facility (Figure 1–1).

1. BSF rearing unit
2. BSFL waste conversion unit (pre-processing, treatment, harvesting)
3. Post processing unit (larvae refining and residue processing)

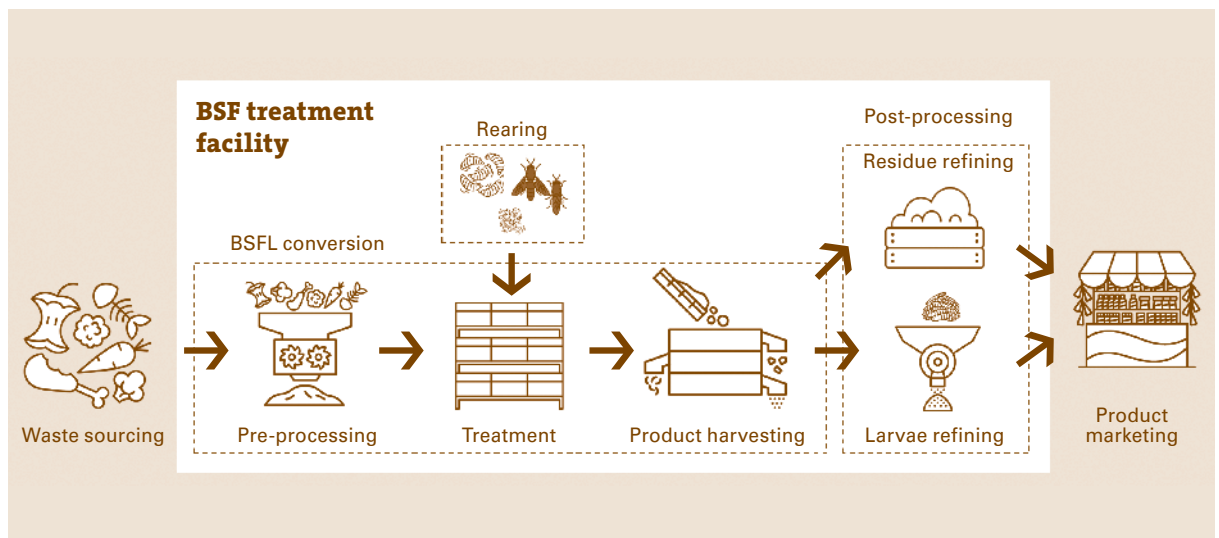

Figure 1–1: The different units of a BSF treatment system

Although proper “waste sourcing” is of crucial importance to a well-functioning BSF facility, this aspect is not discussed in detail in this manual.

Throughout the text, you will come across the following icons. They indicate issues of particular importance, background information or access to further information material.



Highlights issues of high importance



Highlights detailed information for interested readers, but is not required reading



Link to more detailed information, templates and factsheets



Link to the e-learning video series on BSF Biowaste Processing



Chapter 2:

Introduction into BSF biowaste processing

This chapter takes a closer look at the life cycle of the Black Soldier Fly. Understanding the life cycle helps to know why BSF is a suitable insect for organic waste management and to learn how this cycle can be “engineered” to enhance the benefits produced in terms of waste conversion efficiency and product harvest in quantity and quality.

2.1 The Black Soldier Fly

The Black Soldier Fly, *Hermetia illucens*, is of the dipteran family Stratiomyidae. It can be encountered in nature worldwide in the tropical and sub-tropical areas between the latitudes of 40°S and 45°N (Figure 2–1).



Figure 2–1: Distribution area of the Black Soldier Fly, *Hermetia illucens*

The egg starts a BSF life cycle and at the same time marks the end of the previous life stage: a fly laying a cluster of eggs (also called ovipositing). The female fly lays a package of 400 to 800 eggs close to decomposing organic matter, into small, dry, sheltered cavities. Shortly after having laid the eggs, the female dies. The closeness of the eggs to the decomposing organic matter ensures that the larvae have their first food source nearby after hatching. The sheltered cavities

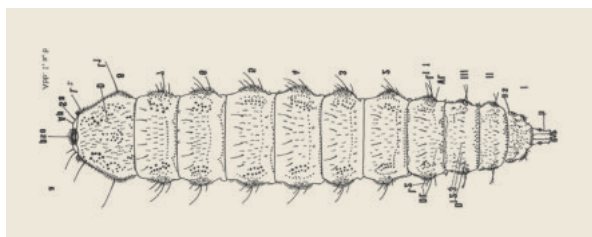

Figure 2–2: Drawing of a Black Soldier Fly larva (Schremmer, 1986)

protect the eggs from predators and prevent dehydration of the egg packages by direct sunlight. On average, the eggs hatch after four days and the emerged larvae, which are barely visible, will search for food and start feeding on the organic material nearby. The larvae feed voraciously on

the decomposing organic matter and grow from less than one millimeter to around 2.5cm length and 0.5cm width, and are of cream-like colour. The different life stages are shown in Figure 2–2 and Figure 2–3.

Under optimal conditions with ideal food quality and quantity, the growth of the larvae will require a period of 14-16 days. However, the BSF larva is a very resilient organism and has the ability to extend its life cycle under unfavourable conditions. The larval stage is the only stage during which the BSF feeds and, therefore, it is during this time of larval development that enough fat reserves and protein are stored that allow the larvae to undergo pupation, emerge as flies, find mates, copulate and (as a female) lay eggs before dying.

After having gone through five larval stages, the larvae reach the final larval stage: the prepupa. When transforming into a prepupa, the larva replaces its mouthpart with a hook-shaped structure and becomes dark brown to charcoal grey in colour. It uses this hook to easily move out and away from the food source towards a nearby dry, humus-like, shaded and protected environment that it deems safe from predators and this is where the imago emerge from the pupa and fly off without significant hindrance.



Figure 2–3: Life stages of the Black Soldier Fly, *Hermetia illucens*, Photos: Nandayure Studt Solano (1a, 1b), Samuel Blyth (2, 3, 4), Sandec (5)

The process of pupation is the transformation from a pupa into a fly. The pupation stage is initiated when the prepupa finds a suitable location and becomes immobile and stiff. For a successful pupation, it is best if the environmental conditions do not change too much or, in other words, that they remain warm, shaded and protected from rain. Pupation takes around two to three weeks and ends when the fly emerges from its pupa shell. The emerging process is a very short procedure. It takes less than five minutes for the fly to break open the part of the pupa that used to be the head section, crawl out, dry and then spread its wings and fly off.

After emerging, the fly lives for about one week. During this short life, it will search for a partner, copulate and (for the female) lay eggs. As a fly, BSF do not feed. Only a source of water or a humid surface is required to stay hydrated. What is important in this life stage is an abundant amount of natural light and a warm temperature (25-32°C). A humid environment may prolong the life span

and, thus, enhance the chance for successful reproduction. It has been observed that the flies prefer to copulate in the light of the morning. After copulation, the females then search for an ideal location to lay their eggs as explained above.

Optimal environmental conditions and food sources for the larvae can be summarized as:

- **Warm climate:** the ideal temperature is between 24 and 30°C. If too hot, the larvae will crawl away from the food in search of a cooler location. If too cold, the larvae will slow down their metabolism, eat less and develop slower.
- **Shaded environment:** larvae avoid light and will always search for a shaded environment, away from sunlight. If their food source is exposed to light, they will move deeper into the layer of food to escape the light.
- **Water content of the food:** the food source has to be quite moist with a water content between 60% and 90% so that the larvae can ingest the substance. In the engineered life cycle we aim at 70-80%.
- **Nutrient requirements of the food:** substrates rich in protein and easily available carbohydrates result in good larval growth. Ongoing research indicates that substrate may be more easily consumed by the larvae if it has already undergone some bacterial or fungal decomposition process.
- **Particle size of the food:** as the larvae have no chewing mouthparts, access to nutrients is easier if the substrate comes in small pieces or even as a slurry.

2.2 Why the Black Soldier Fly?

Several key attributes make BSF promising organisms to manage and “engineer” so that they can be used as an attractive treatment technology for biowaste from the perspective of waste managers and businesses:

- Waste biomass is converted into larvae and residue. The larvae consist of $\pm 35\%$ protein and $\pm 30\%$ crude fat (based on dry mass). This insect protein is of high quality and is an important feed resource for animal feed. Feed trials have confirmed that it is a suitable alternative to fish meal.
- Feeding waste to larvae has shown to inactivate disease transmitting bacteria, such as *Salmonella* spp. This implies that the risk of disease transmission between animals and between animals and humans is reduced when using this technology at farm level or when treating waste of animal origin in general (e.g. chicken manure or slaughterhouse waste). However, risk reduction is achieved mainly through material reduction ($\pm 80\%$) rather than through pathogen inactivation.
- Waste reduction of up to 80 % on wet weight basis has been demonstrated. If BSF processing is applied at or close to the source of biowaste generation, the costs for waste transport and space requirements for landfills can, thus, be reduced drastically. Such organic waste treatment could furthermore reduce open dumping, which is still an unfortunate reality in low- and middle-income settings.
- The residue, a substance similar to compost, contains nutrients and organic matter and, when used in agriculture, helps to improve soil conditions.
- A high waste-to-biomass conversion rate of 15-20% on wet weight basis has been demonstrated, which is a satisfactory output quantity from a business perspective.
- There is no need for sophisticated high-end technology to operate such a facility. Therefore, it is suitable for low-income settings that rely mostly on simple technology and unskilled labour.

2.3 Engineering the BSF life cycle

In an engineered BSF processing facility, we can differentiate distinct processing units as shown in Figure 2-4.

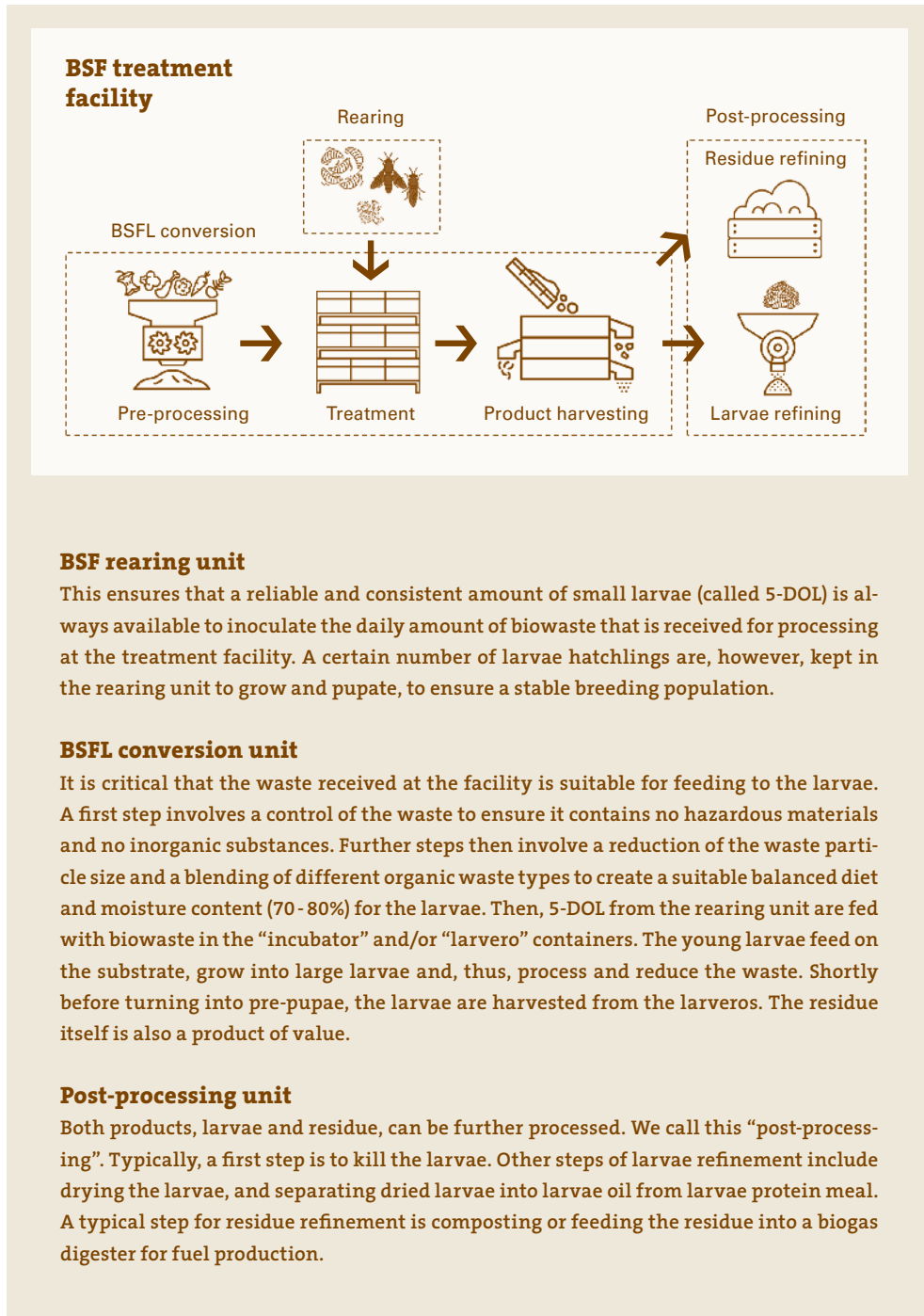

BSF rearing unit

This ensures that a reliable and consistent amount of small larvae (called 5-DOL) is always available to inoculate the daily amount of biowaste that is received for processing at the treatment facility. A certain number of larvae hatchlings are, however, kept in the rearing unit to grow and pupate, to ensure a stable breeding population.

BSFL conversion unit

It is critical that the waste received at the facility is suitable for feeding to the larvae. A first step involves a control of the waste to ensure it contains no hazardous materials and no inorganic substances. Further steps then involve a reduction of the waste particle size and a blending of different organic waste types to create a suitable balanced diet and moisture content (70 - 80%) for the larvae. Then, 5-DOL from the rearing unit are fed with biowaste in the “incubator” and/or “larvero” containers. The young larvae feed on the substrate, grow into large larvae and, thus, process and reduce the waste. Shortly before turning into pre-pupae, the larvae are harvested from the larveros. The residue itself is also a product of value.

Post-processing unit

Both products, larvae and residue, can be further processed. We call this “post-processing”. Typically, a first step is to kill the larvae. Other steps of larvae refinement include drying the larvae, and separating dried larvae into larvae oil from larvae protein meal. A typical step for residue refinement is composting or feeding the residue into a biogas digester for fuel production.

Figure 2-4: Units of a BSF treatment facility

2.4 Safety and hygiene measures when working with BSF and biowaste

During operation of a BSF facility, measures that protect the health of the workers as well as the animals are also a necessity.

Although operation of a BSF facility does not entail high hazards to health, employees are nevertheless exposed to threats such as noise, dust or gaseous emissions as well as exposed to pathogens that may enter the facility through the organic waste. It is therefore important that adequate protective clothing and equipment is always available for the workers. Even if wearing of boots or gloves will meet with little enthusiasm among the employees, especially in a tropical climate, it is the responsibility of the operator to enforce such measures and to set a good example.

As in other livestock farms, care must be taken to maintain hygienic conditions in a BSF facility. The main focus is to prevent the spread of diseases and keeping pests away. For this reason, regular activities that guarantee hygienic conditions must be included in the work plans. This includes the regular cleaning of work surfaces with alcohol as well as the safe storage of animal feed or structural measures that prevent rats or birds from entering sensitive areas of the facility. Maintaining general order in all areas of the facility and daily cleaning of utensils should be standard practice. The facility should also have its own waste concept, which ensures that potentially contaminated materials are stored and disposed of safely.

The schedules used in this manual all include regular tasks to maintain hygiene and safety in the facility. We recommend that operators place as much emphasis on the carrying out of these tasks as they do on those directly related to BSF operation.

The following equipment is part of the standard personal protective and cleaning equipment at any BSF facility:



Broom and dustpan



Facemask



Work coat



Latex-/Lab gloves



Rubber boots



Face shield



Rubber gloves



Heat resistant gloves



Scrubbing brush



Washing machine



Cleaning alcohol



Chapter 3:

The BSF rearing process

3.1 Rearing BSF in a controlled environment

To ensure the treatment of a defined amount of waste on a regular basis, the rearing unit needs to provide a defined number of five day old larvae, so-called 5-DOL, every day. It is, therefore, important to control all single production steps during rearing and to monitor the performance of each step. In a well-engineered BSF nursery, it is possible and easy to control the number of pre-pupae that are allowed to pupate. This helps estimate the number of flies that shall emerge, which in turn provides an indication of how many egg packages will be deposited, how many larvae will hatch and how many of these larvae are available for biowaste treatment. Monitoring of the survival rates at every step in this cycle keeps track of the colony's overall performance and indicates problems at any particular step. Survival rates may differ from one nursery to another. Data provided here are based on a rearing unit in Indonesia (Figure 3–1) and serve as an example.

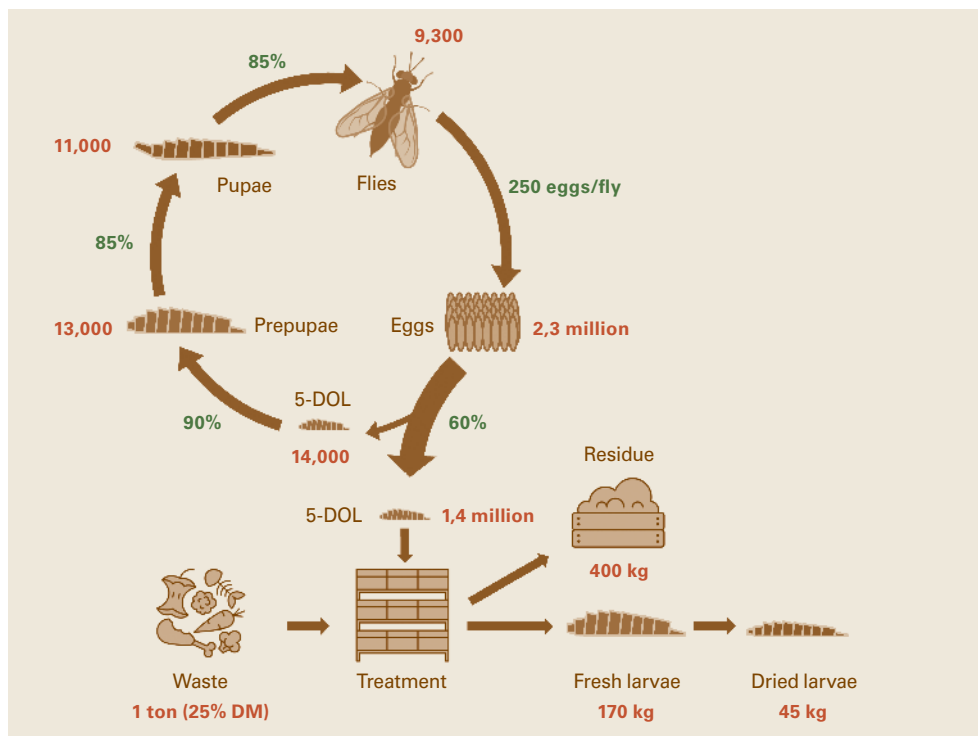

Figure 3–1: Performance indicators of a BSF rearing facility in Indonesia

Egg deposition and egg harvest

From a management perspective, it is important that all egg packages are concentrated in few specific locations. This will significantly facilitate harvesting of the eggs.

For this, we supply the cages with a suitable medium (called “eggies”) that satisfies the flies’ requirements regarding a safe location (i.e. sheltered cavities) for egg deposition, as well as an “attractant” which mimics decomposing organic matter that attracts the female to lay eggs close by. Once the egg packages are deposited into the eggies, they are harvested before any larvae hatch. After the eggs are harvested, they are removed from the eggies and placed into egg holders which are then placed over some feed so that the hatchlings can directly start to feed once they hatch and drop from the egg holders into the feed (see Figure 3–2).

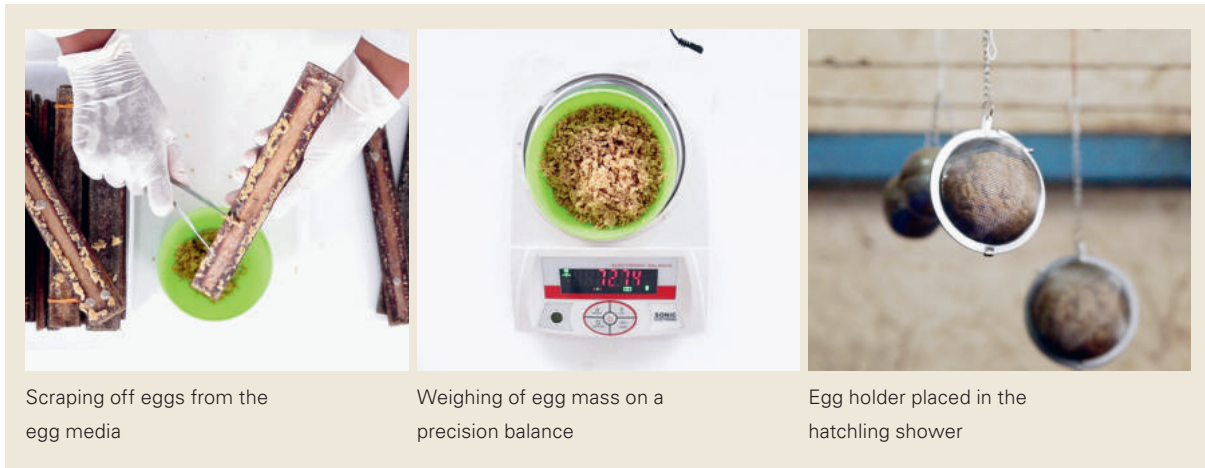

Figure 3-2: Handling of the egg harvest

Egg hatching and larvae feeding

The unit which accommodates the egg holders and the nursery boxes containing the feed for the hatchlings is called the “hatchling shower” (Figure 3-3). The eggs will hatch over a period of several days and the hatchlings will constantly fall into the hatchling container below where they will immediately start feeding. This hatchling container is exchanged on a regular basis. This allows cohorts of young larvae of the same age to be together in each container. Placing recently harvested eggies together with the older eggies guarantees a constant “shower” of hatchlings into the hatchling container. A high quality food source in the hatchling container consists of chicken feed for starter broiler chicks, mixed with water. This feed seems to be the most readily available nutritious material to ensure fast growth of the larvae although it is costly. Alternative materials that can be used, often available free of charge, are soy-based (e.g. soy milk), dairy-based (e.g. expired milk powder) and/or grain-based (e.g. expired bread) waste products. It is important though that the nutritional content of the mixture remains stable given the strict and regular feeding schedule. This mixture of feed should have a water content of around 70% which results in the ideal substrate texture for the larvae to feed on.



Figure 3-3: Hatchling shower: harvested egg mass is placed in holders above a feed source for the newly hatched larvae. Each paperclip colour represents a different day of the week when egg were harvested

Waste management with BSF larvae is easiest with uniform larvae (same age and size). This allows for better planning of the waste input, conversion rate and harvesting time. By using the hatchling shower, the number and age of young larvae in one hatchling container can be controlled and determined. The frequency of replacing the hatchling container determines the uniformity of the batch of larvae. The higher the frequency of replacement, the higher the uniformity of the young larvae. After hatching, larvae remain in the same hatchling container for five days to feed. Then the 5-DOL are harvested from the hatchling containers, counted and a main share is then transferred to the BSF treatment unit where these 5-DOL are added to the substrate.

As counting all these small larvae is too much work, the number of 5-DOL is estimated by counting the number of larvae in a small sample (~2g), which then is extrapolated based on the total weight of all 5-DOL.



The hatching container below the hatching shower is replaced with a new hatching container at regular intervals (every one to three days). The frequency determines the uniformity of the batch of larvae.

A small fraction of the 5-DOL (1-2 %) is kept in the rearing unit depending on the amount of substrate to be processed and the performance of the nursery. High survival rates and many eggs per female will require that less 5-DOL are kept in the rearing unit. The retained larvae are placed into a nursery container where they are continuously fed with a well-defined feed mixture until they transform into pre-pupae within about three weeks after hatching. All larvae in one nursery container will transform around the same time as they are of the same age. The pre-pupae will leave the food source in search for a more suitable dry location to pupate. To collect these migrating larvae, the nursery container is placed into a transfer container with a dry, water absorbing material (Figure 3-4).



Figure 3-4: Nursery containers standing in transfer containers

Pupation

Pre-pupae that have crawled into the transfer container are harvested and transferred into a pupation container. As pre-pupae are disturbed when too close to other pre-pupae, the containers contain a moist soil-like substrate (compost) into which the pre-pupae can bury (Figure 3-5).



Figure 3-5: Pre-pupae being added onto the pupation material in the pupation crate



Figure 3-6: Pupation boxes in pupation rack

The density of pre-pupae in the pupation container influences how quickly the pre-pupae settle down and stiffen their bodies to start their transformation into pupae. To facilitate the pupation process, the pupation containers are first placed in a pupation rack (Figure 3–6) where pre-pupae are continuously added in smaller amounts into the pupation crates over a period of 5 days. For the pupation process, the pupae are placed inside a pupation cage, which is completely dark inside (Figure 3–7). We call these “dark cages”. In addition to the dark environment, this cage also provides the pupae with sufficient protection from the changing outside environmental conditions (i.e. moisture, temperature, movement of air, etc.). After two to three weeks, the pupation material has slightly dried out, making it easier for the flies to crawl out of the pupal skin to the top of the material and fly out of the pupation containers. But they still remain contained in the dark cage. Due to the darkness inside the cage, the emerged flies will not mate, but will remain motionless. The flies in the dark cage, thus, are a constant source of “fresh” adult flies which, as soon as they are released into the light, will start to reproduce.



Figure 3–7: Dark cage with pupation containers stacked within



Figure 3–8: A love cage is being filled with freshly emerged adults

Emergence of the adults starts twelve days after they were put into the pupation box, and the frequency of emergence then follows a bell-shaped curve and ends with a few latecomers after 25 days (Figure 3–9).

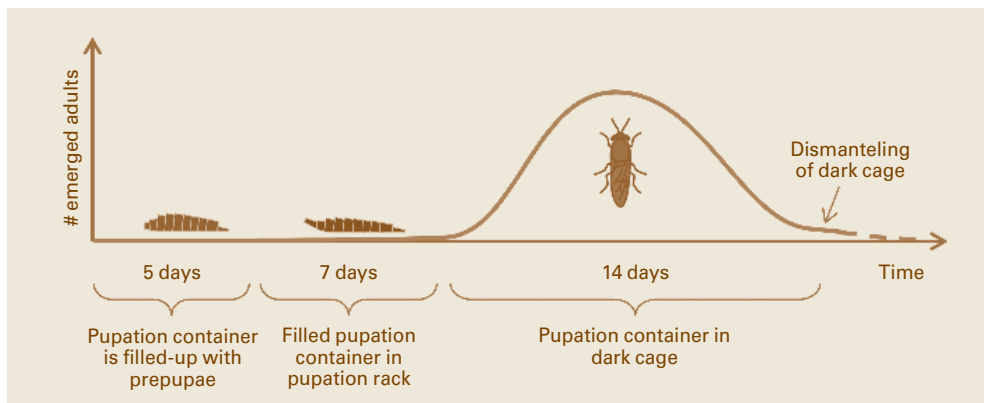

Figure 3–9: Dynamics of pupation and emergence of black soldier flies

Mating

Emerged flies are collected from the dark cage and transferred to the love-cage. This is done by connecting the dark cage with a tunnel to a cage that is not darkened and is hanging in a mobile frame. Because this is the place where mating will take place, we call it the “love cage” (Figure 3–8). The light set at the love-cage end of the tunnel will attract the flies towards the light to fly from the dark cage into the love cage. A love cage is consecutively connected to three to four dark cages to collect the most recently emerged flies from all these cages (Figure 3–10). This method allows for a constant and stable density of flies within the love cages. Moreover, the flies harvested are all of a very similar age. Same-aged-flies in the love cage has an important benefit: the flies will copulate and lay eggs around the same time and are, thus, predictable, and allow for a more efficient nursery operation. The love cages are equipped with a wet cloth to allow the flies to hydrate and with eggies and a box with a smelly attractant. The rearing cycle has, thus, been closed.

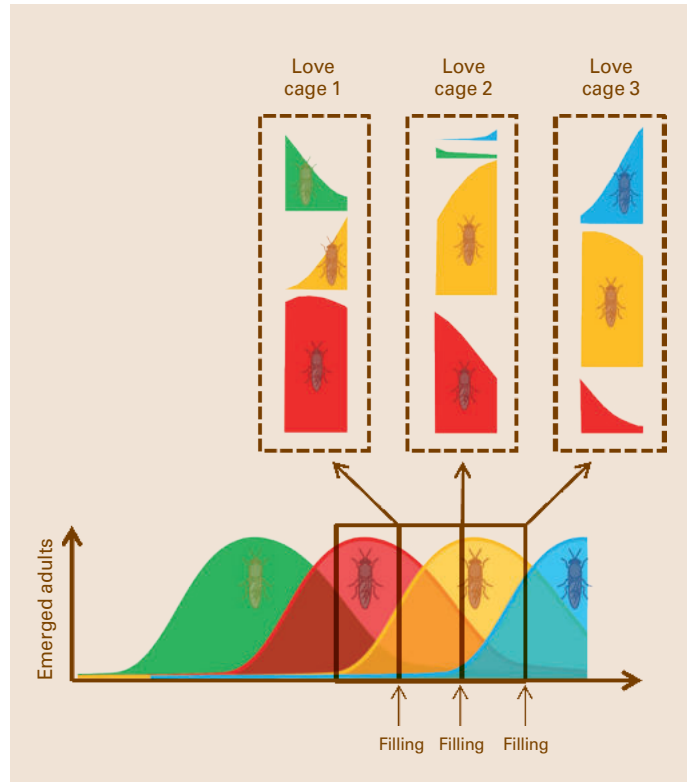

Figure 3–10: Composition of three love cages filled at intervals of two days from four different dark cages



Let there be light

For successful reproduction, Black Soldier Flies require a certain type and intensity of light. Ideally, this is natural sunlight. In cases where this is not possible, either because of seasonal variations due to latitude or because the plant must be operated in a room without windows, sunlight must be replaced (or supported) by artificial light.

When selecting the lamp, attention must be paid to both the spectral composition of the light and the intensity. The light spectrum with high values in the blue (~440 nm) and green range (~540 nm) showed good reproduction rates. In addition to the wavelength, however, the power of the lamp also plays a major role. This is measured in $\mu\text{W}/\text{cm}^2$ and is given in relation to the distance to the light source. We achieved good results with a light power in the UV range of $210 \mu\text{W}/\text{cm}^2$ and an illuminance of about 3,000–6,000 lx at a distance of 60 cm¹.

It is important to ensure a day-night rhythm, with the duration of illumination between 6 and 18 hours per day.

¹ Macavei L, Benassi G, Stoian V, et al. (2020) Optimization of *Hermetia illucens* (L.) egg laying under different nutrition and light conditions. PloS ONE 15: and Liu Z, Najar-Rodriguez A, Minor M, et al. (2020) Mating success of the black soldier fly, *Hermetia illucens* (Diptera: Stratiomyidae), under four artificial light sources. Journal of Photochemistry and Photobiology B: Biology 205: 111815.

3.2 Activities in the BSF rearing unit

In this subchapter, the process steps and the materials to use during these steps are presented. Most of the materials are so called off-the-shelf items which can be purchased at local hardware stores. Some materials and equipment have been custom-made for the operation. The dimensions of these items are provided in the description under each item.



The **technical drawings for the custom-made materials** and equipment used in the operational steps of the BSF rearing unit can be found through this link.

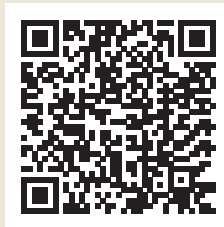

3.2.1 Fly stage

A love cage is filled with freshly emerged flies from the dark cages. In the love cage, the flies are provided water to drink and a place to lay their eggs. The love cage presented here can hold up to 10,000 flies which equals around 84cm³ per fly. The flies will stay in the love cage for 4 days where they mate and lay eggs.

Materials and equipment needed:

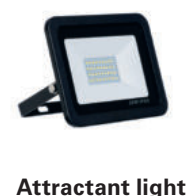



Tasks:

- Step 1:** Hang a clean love cage onto its hanger using the loops and measure weight of the love cage with hanger.
- Step 2:** Attach the cage onto the mobile frame and move the frame opposite the first dark cage. Connect the two tunnels of the cages, using four binder clips. Turn on the attractant light and gently shake the cage to rouse the flies.



Step 1: Attaching cage to hanger



Step 2: Using the cage moving stick to hang love cage into mobile frame

- Step 3:** After 30 minutes, disconnect and close the tunnels, measure the weight of the love cage and hanger, attach the hanger with cage onto the mobile frame again and repeat the same process of connecting, disconnecting and weighing after 30 minutes until the love cage is full (flies are covering most of the sides but are not piling up on the bottom).
- Step 4:** Disconnect the love cage from the last dark cage and turn off the light. Close the tunnels with rope and measure weight of love cage and hanger. Move the love cage with hanger to the love cage table using the long stick with a hook and hang up.

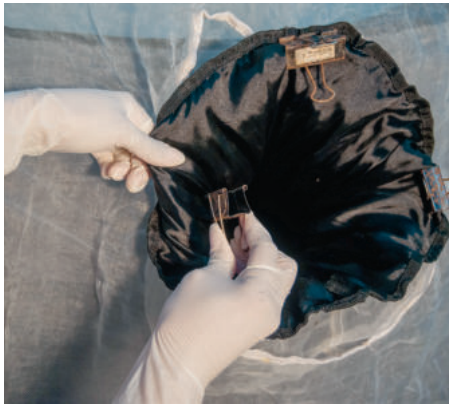

Step 2: Attaching dark cage to love cage from inside



Step 3: Light lures flies from dark cage into love cage

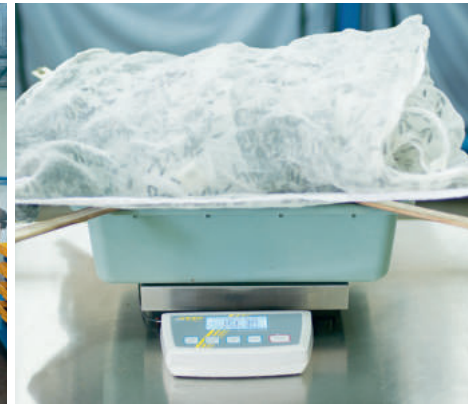

Step 4: Weighing of love cage after filling

Step 5: Prepare attractant container: fill an empty attractant container with 100 grams of dead flies, 200 grams of residue from the nursery containers, 200 grams of residue from the old attractant container and one litre of water. Mix thoroughly.

Step 6: Prepare 10 clean eggies: Take clean wooden sheets and separate them with pushpins on both sides and sheets without pushpins. Build up the egg media alternating between a sheet with and without pushpins until five sheets are stacked. Add two rubber bands on both ends of the bundle. Prepare 10 of these bundles (eggies) for each love cage.



Step 5: Ingredients of the attractant container



Step 6: Wooden sheets with pushpins to create a gap, allowing space for egg packages. The eggies are held together with two rubber bands

Step 7: Prepare water container: Fill a clean container with tap water until it is almost full. Take the lid and a clean cotton cloth and push the cloth on both side through the incision slits made into the lid. The towel should lie flat on top of the lid, while its ends pass through the incision slits and are immersed in the water in the container. Sprinkle the towel with water.

Step 8: Open the love cage. Collect 20 flies in a jar. Then place the attractant container with 10 clean eggies cross-stacked on top into the love cage. Cover the attractant container and eggies with the shading basket. Place the water container onto the shading basket and close the love cage.



Step 7: Adding water onto water container to moisturise the cloth



Step 8: The whole eggie-set-up

Step 9: After closing the love cage, add a sticker on the table under the cage labelling the date of placement. The cage should now be fixed as displayed in the figure below.



Step 9: Leg of love cage table is placed in ant trap



Step 9: Newly set-up love cage



PROTECTIVE MEASURES FOR WORKERS:

- Pay attention to the light attached to the mobile frame and avoid burns.
- Use lab coat and latex gloves when handling attractant.



POINTS OF MONITORING AND DATA COLLECTION:

- Weighing the love cage after every connection to a dark cage (Step 3) allows for the monitoring of the emergence rate from dark cages and yields the total number of flies in a love cage. A reference sample of 20 flies is taken from the filled cage with a cylindrical container. The flies in the cylindrical container are brought to the laboratory where the container is quickly turned upside down on a smaller cylindrical container with cork chips sprinkled with 10-15 drops of ethyl acetate. This is left for 30 seconds to paralyze the flies, so that they can then be easily weighed with a precision balance. Divide difference of empty and full love cage by the average weight of one fly to obtain the number of flies in the love cage.



The **fly stage module from the e-learning video series** on BSF Biowaste Processing is available through this link.



3.2.2 Egg Stage

Love cages are removed after four days of use. No more eggs will be laid after this period as most females die within one week. Eggies are removed from the love cage and the eggs are then scraped off the eggies. The eggs are placed in a holder which is hung up in the hatchling shower where newly hatched larvae fall into the hatchling container. 10,000 flies in a cage produce around 75 grams of eggs. The capacity of one egg holder is 40 grams which means around two egg holders are filled with the eggs from one love cage. The hatchling container is replaced regularly and the same age cohort of larvae feed in the same container until they are used for the waste treatment. Each hatchling container can receive the equivalent of 40 grams of hatched eggs.

Materials and equipment needed:



Tasks:

- Step 1:** Remove the eggies from the love cage, 4 days (4x24h) after the love cage was setup.
- Step 2:** Remove the old attractant container. Use 200grams of old attractant residue for filling a new attractant container. Empty the remainder of the residue into the organic waste bin. Clean the attractant container with detergent and let it dry.
- Step 3:** Sweep the dead flies from the love cage you are dismantling. Keep 100 grams of dead flies for filling the new attractant container and dispose of the others into the organic waste bin.



Step 1: Removing eggies from love cage

Step 4: Disconnect the hanger with love cage from the love cage table, remove the hanger and turn the love cage inside out, shake it to remove the last (dead) flies and place the love cage into the washing machine, add detergent and wash it on a 30°C program. Remove the love cage from the washing machine and let it dry.



Step 4: Dismantling the love cage



Step 4: Wash Love cage after every use in washing machine

Step 5: Clean the love cage table where the old cage was attached. Spray the same space with a 95% alcohol solution, spread it out with a cloth and let the alcohol dry. Remove the date label of this love cage from the table.



Step 6: Remove one week old egg holders from hatchling shower

Step 6: From the hatchling shower frame, remove all the egg media holders with the colour coded clip of the current weekday. Egg media holders are marked with a paper clip in a particular colour according to the day they were put onto the hatchling shower (e.g. Monday = Yellow, Tuesday = Purple, Wednesday = Grey, etc.). Egg media holders with today's colour-code have been hanging in the hatchling shower for one week and all the eggs have already hatched.

Step 7: Take the 10 eggies removed from the dismantled love cage and carefully open the wooden sheets of the first eggie by removing the two rubber bands on each end. Use a tweezer to carefully scrape off the eggs on both sides of each of the five sheets making up one eggies. Collect the egg mass in a small bowl. Repeat the process for the other 9 eggies and then for the other love cages dismantled on the same day.

Step 8: Weigh the total collected egg mass from all eggies removed from one love cage. Divide the egg mass up in portions of 40 grams, open the first egg media holder and add the first batch of 40 gram egg mass. Repeat this process ensuring that the amount of egg mass is max 40 grams per holder and the amount added to each holder is the same. Then hang the holders in the hatchling shower ensuring that at least one holder is hung over a hatchling container each day



Step 8: Fill egg holders with egg mass



Step 8: Attach color coded paperclip to egg holder

Step 9: Prepare the hatchling container. Each hatchling container replaces the previously setup hatchling container in the shower rack. For each hatchling container produce a 3kg mixture of 30% dry chicken (broiler) feed and 70% water. Stir the mixture until it has become a homogeneous substance. Fill the hatchling containers each with the 3kg mixture. Cover each hatchling container with dry and sieved cocopeat or wheat bran (0.5-1.0 cm thickness) to avoid loss of moisture. Add labels to each hatchling container with the date code of the current day.



Step 9: Hatchling container is filled with 3kg of fresh larva feed



Step 9: The nursery feed is covered with a thin layer of cocopeat to avoid moisture loss

Step 10: Move all existing hatchling containers in the shelves down by one shelf. The lowest hatchling containers will have five day old larvae. In the now empty top-most shelf, add the new hatchling containers.



PROTECTIVE MEASURES FOR WORKERS:

- Mask and glasses to protect face from eggs and small larvae.
- Use lab coat and latex gloves for handling eggies, attractant, dead flies and detergent.



POINTS OF MONITORING AND DATA COLLECTION:

- Measure weight of the eggs in the removed egg media. See Step 7 for details.
- Calculate the number of eggs harvested:
 - Total number of eggs harvested: E_{total} (number)
 - Total mass of eggs harvested: M_{total} (gram)
 - Mass of one egg: M_{egg} (gram) = 0.0000291 grams per egg

$$E_{\text{total}} = M_{\text{total}} / M_{\text{egg}}$$



The **egg stage module from the e-learning video series** on BSF Biowaste Processing is available through this link.



3.2.3 Hatchling stage

The 5-DOL are harvested from the hatchling container. At the age of 5 days old, this crate has the capacity to hold around 700,000 larvae or 73 larvae per cm³. The 5-DOL are then separated from the residue and their total number is determined.

Materials and equipment needed:

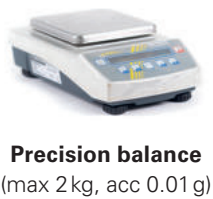

Tasks:

Step 1: Remove the oldest (after 6 days) hatchling containers from the shower rack. If you have multiple containers, mix them together. Use a manual sieve (mesh size 0.8mm) to sieve all the material in the hatchling containers. The small residual particles together with the small larvae will fall through the sieve into a container, while larger residue particles and larvae stay on the sieve. The larger residue and larvae that stay on the sieve are placed in a plastic box. From this box, the larger residual particles are scooped off with a spoon as much as possible and stored elsewhere until lumps of 5-DOL are clearly visible (while some residue will still also remain). Tapping on the wall of the plastic box will help to separate larvae from residue as the vibrations make the larvae aggregate.



Step 1: Scooping off residue from the 5-DOL to create a pure fraction

Step 2: Clean the hatchling containers with the pressure washer, a scrubbing brush and detergent and let dry.

Step 3: Take a random scoop from the purified 5-DOL mixture and measure two grams each of the mixture into two cups.



Step 3: After mixing to homogenize the purified section of 5-DOL, a random scoop is taken

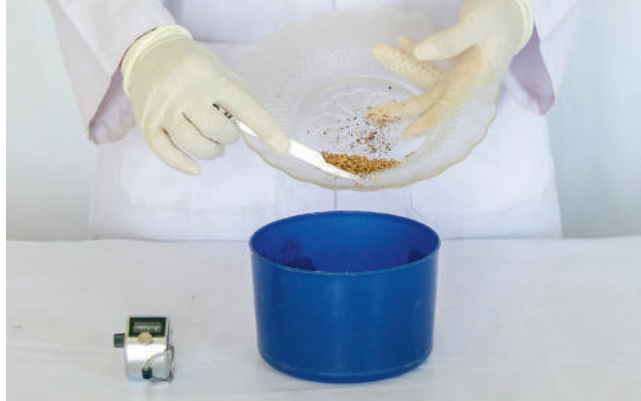

Step 4 : The 5-DOL contained in the 2 gram samples (including the unavoidable remaining residue) are counted

Step 4: Place these two grams of 5-DOL mixture from the cup onto a plate. On the plate, manually count all the 5-DOL using tweezers and a click counter, by pushing them into a bowl. Repeat the process for the second cup as well. Document the result as number of 5-DOL per two grams.

Step 6: Weigh the total mass of all 5-DOL available in the box. Using the results of the count per two grams, calculate the total number of larvae in that box. See calculation below.

Step 7: Based on the number of incubator units to be set-up (which depends on the substrate amount), prepare cups and fill each cup with the weight of 5-DOL mixture from the box, as needed for each larvero. See calculation below.

Step 8: The remaining 5-DOL will then be used for rearing flies or discarded (see Fly stage)



Step 6: Portioning of 5-DOL for the preparation of the incubator units



PROTECTIVE MEASURES FOR WORKERS:

- Use lab coat and latex gloves for handling 5-DOL and residue.



POINTS OF MONITORING AND DATA COLLECTION:

- Calculating the number of larvae in the box:
 - Total number of larvae in box: L_{total} (number)
 - Total mass of larvae in box: M_{total} (gram)
 - Number of larvae in sample: L_{sample} (number)
 - Mass of sample: M_{sample} (gram)

$$L_{total} = M_{total} * L_{sample} / M_{sample}$$



POINTS OF MONITORING AND DATA COLLECTION:

- Calculating the mass of larvae needed per larvero:
 - Mass of larvae needed per larvero: $M_{larvero}$ (gram)
 - Number of larvae required per larvero: $L_{larvero}$ (number)
(we calculate with 600-800 larvae per kg of wet substrate fed during the whole treatment period)
 - Total mass of larvae in box: M_{total} (gram)
 - Total number of larvae in box: L_{total} (number)

$$M_{larvero} = L_{larvero} * M_{total} / L_{total}$$



The **hatchling stage module from the e-learning video series** on BSF Biowaste Processing is available through this link.



3.2.4 Larval growth stage

The nursery containers provide the pre-pupae which go into the pupation containers to maintain the necessary adult population. The required number of 5-DOL are fed for approximately two and a half weeks until they turn into pre-pupae. During this time, 10,000 larvae are kept in one nursery Larvero or at a density of 5 larvae per cm².

Materials and equipment needed:



Nursery Larvero rack
(150x45x65 cm)



Nursery Larvero
(55x35x14) and transfer
container (60x40x12 cm)



Precision scale
(max 35 kg, acc 0.5g)



Spade



Beaker
(3L)



Bulk scale
(max 150 kg, acc 50g)



Bin
(80L)



Water



Chicken feed
(Protein 23%, Water 13%,
Fat 5%, Fibers 5%
& ash 7%.)



Cocopeat

Tasks:

- Step 1:** Prepare 2 kg of food made up of 30% dry chicken feed and 70% water. Stir it until it is a homogeneous mixture.
- Step 2:** Take a clean nursery larvero and add this food to it, cover it with cocopeat or wheat bran (layer of 0.5-1.0 cm) and then add 10,000 5-DOL on top of the coco peat.



Step 3: Put cocopeat in the corners of the transfer box to hinder the pre-pupae from escaping



Step 3: Place the nursery container with the 10,000 5-DOL into the transfer container

- Step 3:** Take a clean transfer container and add cocopeat into the corners and along the edges of the container and place the nursery larveros into it. Since pre-pupae will eventually crawl out of the nursery larveros and fall into the transfer crate, the nursery larveros (35x55cm) needs to be slightly smaller than the transfer container (40x60cm). Put the two on the nursery shelf.

- Step 4:** Place a sticker with the date code and the amount of larvae that have been added on the nursery larvero.

- Step 5:** During the two and a half weeks of operation, the nursery larveros receive a mixture of chicken feed and water in different concentrations. This mixture is fed on specific days within the time period according to feeding schedules (see Annex B).

- Step 6:** After two and a half weeks (see Annex B), the nursery larvero is removed and the remaining pre-pupae in the transfer container are harvested (see also the activities in the pre-pupae stage)

- Step 7:** Remove the residue in the old nursery larveros. The residue can be composted. Clean the nursery larvero and transfer container with a scrubbing brush and detergent and let dry.

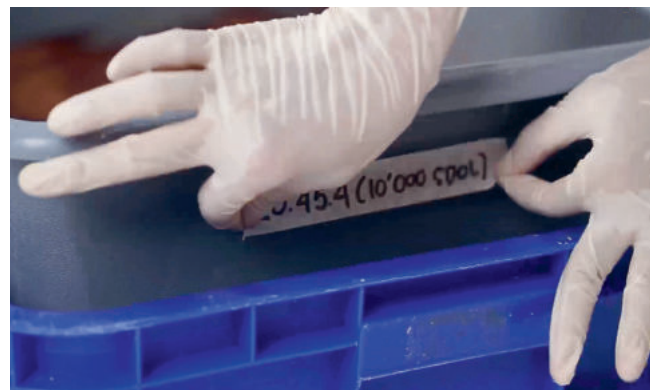

Step 4: Place sticker on nursery larvero



Step 5: Add feed to nursery larveros during weeks of feeding



PROTECTIVE MEASURES FOR WORKERS:

- Use lab coat and latex gloves for handling larvae and residue.



POINTS OF MONITORING AND DATA COLLECTION:

- None.



The **larval growth stage module from the e-learning video series** on BSF Biowaste Processing is available through this link.



3.2.5 Pre-pupae stage

The pre-pupae, which have crawled out from the nursery containers, are placed into the pupation containers which later are put into the dark cage. Over a duration of 5 days, the pre-pupae are added into the pupation substrate which has a thickness of around 5 cm in the pupation crates. Up to 10,000 pre-pupae fit in one pupation crate or around 1 pre-pupa per cm^3 of pupation material.

Materials and equipment needed:



Mixer
(max cap. 300 kg)



Compost or other soil-like material



Water



Pupation containers
(60x40x12 cm)



Pupation rack
(190x45x60 cm)



Precision scale
(max 35 kg, acc 0.5 g)



Precision balance
(max 2 kg, acc 0.01 g)



Cup



Bin
(80 L)



Sieve
(60x40x10, mesh size 3 mm)



Collection container
(30x20x12)



Bulk scale
(max 150 kg, acc 50 g)

Tasks:

Step 1: Prepare pupation material: 50 kg of pupation material is made of mature compost ($\frac{3}{4}$) and water ($\frac{1}{4}$). Mix it thoroughly with a concrete mixer until no dry material is visible and the mixture is homogeneous.



Step 1: Mixing dry compost with water



Step 1: Stir the materials into a moist pupation substrate

- Step 2:** Take 16 clean pupation containers and fill them each with 3 kg of the prepared pupation material. Spread the mixture equally over each crate.
- Step 3:** Place the 16 pupation containers in the pupation rack and add a sticker with the date of setup.
- Step 4:** Harvest the pre-pupae together with the cocopeat from the transfer container and separate the pre-pupae from the cocopeat with a sieve. The empty transfer container is then filled again with cocopeat and the nursery container is placed in it again. This same process is repeated for each transfer container assigned to be harvested that day. Note the weight of the harvested pre-pupae for each individual container for monitoring purposes.



Step 4: The pre-pupae are separated from the cocopeat by sieving it with a 3mm sieve



Step 5: Counting of 200 pre-pupae to assess the average weight for portioning them to the pupation containers

- Step 5:** Pool all harvested pre-pupae from each transfer container harvested this day and weigh the harvested pre-pupae on a bulk balance. From these pooled pre-pupae, two samples of 200 pre-pupae are weighed, counted and its average is noted down.
- Step 6:** Prepare 16 batches of pre-pupae according to the amount required by the checklist (Annex A), one batch for each pupation crate that will receive pre-pupae.
- Step 7:** Transfer the 16 batches of pre-pupae into each of the 16 pupation boxes. The same pupation boxes are filled with the same number of pre-pupae over several days, according to the respective schedule (see Annex A).



Step 6: Prepare batches of pre-pupae in cups



PROTECTIVE MEASURES FOR WORKERS:

- Use lab coat and latex gloves for handling larvae, pre-pupae, coco-peat and compost.



POINTS OF MONITORING AND DATA COLLECTION:

- The weight of pre-pupae harvest from each transfer container is measured.
- The weight of 200 pre-pupae is measured. This is repeated twice to obtain an average value.



The **pre-pupae stage module from the e-learning video series** on BSF Biowaste Processing is available through this link.



3.2.6 Pupae stage

Pupation containers are placed into a dark cage where flies will emerge and eventually move to a love cage. The dark cage can hold 16 pupation crates with each 10,000 pupae (10cm³ per pupa).

Materials and equipment needed:



Dark cage
(150x150x75cm)



Dark cage frame
(170x155x80cm)



Ant trap

Tasks:

Step 1: Hang a clean dark cage onto the dark cage frame using four ropes to tie it in the top corners to the frame. Open the zipper door in the front of the cage and close the round tunnel opening.



Step 1: Hanging up new dark cage

Step 2: Ensure that the bottom of the dark cage lies on the dark cage frame table which has its table legs placed in ant traps.

Step 3: Fill the new dark cage with 16 pupation containers as prepared following the activities in the pre-pupae stage. Cross-stack the pupation containers. Make sure that enough open space remains between the containers so that the emerged flies can exit the containers.



Step 3: Filling dark cage with pupation containers and closing the zipper/tunnel so flies can't escape and the cage is dark

Step 4: Label the dark cage on the frame with the date of its set-up.

Step 5: Remove the 16 pupation containers from the cage that needs to be dismantled today according to the schedule. Empty them into a dustbin. Use the pressure washer, a scrubbing brush and detergent to clean the 16 crates and store them to dry.

Step 6: If present, remove dead flies from the dark cage with a brush and dispose of them in a dustbin.

Step 7: Detach the dark cage from the frame and turn the dark cage inside out and wash with detergent in a washing machine using a 30°C program. Then, remove the dark cage from the washing machine and let dry.

Step 8: Clean the dark cage frame. Spray the frame with a 95% alcohol solution, spread it out with a cloth and let the alcohol dry.

Step 9: Remove the date label from the frame.



PROTECTIVE MEASURES FOR WORKERS:

- Use lab coat and latex gloves for handling pupation containers, dirty dark cages and detergent.



POINTS OF MONITORING AND DATA COLLECTION:

- None required.



The **pupae stage module from the e-learning video series** on BSF Biowaste Processing is available through this link.



3.3 Work scheduling and data management

The activities covered in this chapter all relate to the rearing of the Black Soldier Fly. Although the system proposed has a simple and low-tech design, the large amount of handlings can make the operation complex. A work schedule is available (see Annex A) that helps structure all the handlings in a step-by-step approach thereby creating an organised overview of which steps must be performed each day. The steps are organised according to the order in which they have to be executed on the given days. The operator should therefore always start at the top of the checklist and work down the list after completing each task. This will ensure that a later step will not be hindered by a previous step that has not been completed. Working through the list systematically from top to bottom ensures a smoother flow of the process and increases the performance of the operators.

At different moments during the operational steps and as shown in the work schedule, data needs to be collected and entered to ensure monitoring and a good overview of the rearing cycle performance. Digital systems may be available to assist with direct input of the data to produce overviews of performance. However, if digital tools and software are not available, we recommend a simple paper log sheet that is available in Annex D. The log sheet allows entry of data on egg mass, 5-DOL count, pre-pupae mass, pupae input and fly mass. How to collect this data is explained in the respective stages of this chapter.



Chapter 4:

BSFL conversion operations

4.1 Sourcing biowaste

Larvae are generally very tolerant when it comes to feeding substrates. Yet, it is important that the biowaste received at the facility is suitable as larva feed. With a water content between 60% to 90% and a specific particle size, most organic materials will be treated in one way or the other. A list of biowastes known to result in satisfactory growth and biomass conversion is shown in Table 4–1. The larvae strongly rely on symbiotic microorganisms which degrade cell structures and make nutrients available for the larvae to take up. With suboptimal feed, development time will be extended and the final larval weight will be lower. It is important to keep this in mind when looking at the BSF facility from an economic perspective.

Table 4–1: Different types of biowaste found suitable for BSF treatment

Municipal waste	Agro-industrial waste	Manure and faeces
<ul style="list-style-type: none">· Municipal organic waste· Food and restaurant waste· Market waste	<ul style="list-style-type: none">· Food processing waste· Spent grains· Slaughterhouse waste	<ul style="list-style-type: none">· Poultry manure· Pig manure· Human faeces

This guide assumes that “waste sourcing” for the facility has been arranged and secured. The biowaste should be purely organic and biodegradable, and meet the criteria of appropriate biowaste types as mentioned above.



Waste sourcing

In order to guarantee a reliable operation of the BSF facility, a constant waste source of consistent quality is of utmost importance. It is therefore advisable to negotiate long-term contracts with local waste producers once an appropriate waste source has been identified. Criteria to identify a suitable waste source are:

1. **Substrate availability and costs:** Is the material available in regular sufficient quantity and quality and what are the costs (purchase, transport, separation)?
2. **BSFL process performance:** Is the material suitable as a food source for the larvae and to what extent does this affect the time spent in the larveros until harvesting?
3. **Product safety:** Does the waste contain substances (pathogens, heavy metals, pesticides, etc.) that could have a negative impact on the health of personnel and/or larvae or ultimately affect the quality of the final product?
4. **Waste recovery hierarchy:** Does access to a specific waste source affect an existing waste system? How has this waste been disposed of or used in the past and who benefited from it (animal feed, biodigester)?

4.1.1 Biowaste pre-processing

A first step upon arrival of the waste involves a waste quality control to ensure that it contains no hazardous materials and no inorganic substances. A few plastic bags in the waste may not pose a significant problem and can be sorted and removed manually. However, it is critical to keep

hazardous contaminants out of the waste as these may affect all the living organisms: the larvae, associated bacteria and, of course, the workers. Acids, solvents, pesticides, detergents and heavy metals fall into this category and it is especially critical to keep them out when they are in a liquid or dissolved form, as this can easily contaminate the whole batch of waste material. If such contamination is suspected, the waste should be refused.



Figure 4-1: Hammer mill for waste pre-processing

With the waste quality ensured, the next required step then involves a reduction of the waste particle size. This can be achieved by using a shredder or hammer mill (Figure 4-1). Whatever type of technology is used, the equipment should shred the waste to particles of smaller than 1-2 cm in diameter. This helps speed-up BSF processing as BSF larvae do not have appropriate mouthparts to break apart large chunks of waste, and increasing the surface area fosters the growth of the associated bacteria. Efficient shredding of the waste also increases the homogeneity of the residue, which improves its quality and then later simplifies the separation of larvae and residual material.



Greenhouse gas emissions

Given the continuing efforts of nations and local governments towards reducing greenhouse gas emissions, and the commitments taken by all states that are parties to the United Nations Framework Convention on Climate Change, decision-makers increasingly evaluate the Global Warming Potential (GWP) of different treatment options when choosing biowaste management approaches. For the more conventional approaches such as composting or anaerobic digestion this information is well established and simplified methodologies are available under the Clean Development Mechanism (CDM) framework. However for more recent technologies, such as BSF waste treatment, to-date such information is scarce. However first results indicate that gaseous emissions from the degradation process, such as carbon dioxide (CO₂), methane (CH₄) and nitrous oxide (N₂O), are not a concern in BSF treatment. The studies show lower emissions compared to the other treatment methods^{2,3}.

- ² Ermolaev E, Lalander C and Vinnerås B. (2019) Greenhouse gas emissions from small-scale fly larvae composting with *Hermetia illucens*. Waste Management 96: 65-74.
- ³ Mertenat A, Diener S and Zurbrügg C. (2019) Black Soldier Fly biowaste treatment – Assessment of global warming potential. Waste Management 84: 173-181.

Shredded waste with a water content above 80% (Figure 4-2) will need to be mixed together with another, dryer waste source to obtain a resulting moisture content of the mixture below 80%. At 80% water content the shredded waste will have a consistency of a fruit mix (smoothie) from your kitchen blender.

If the water content is below 70% (Figure 4-4), then water needs to be added. Suitable water content can be determined by squeezing a handful of substrate in your closed fist. If less than a few drops of water emerge between your fingers, then the substrate is too dry. When moistening the substrate with water, make sure the water is clean and not contaminated with pathogens, heavy metals or other anti-nutritional elements. A substrate with a moisture content between 70 and 80% usually has a moist look but will firmly stay as a pile when added into the larvero unit (Figure 4-3)



Figure 4-2: Biowaste with water content >80%



Figure 4-3: Biowaste with water content 70-80%



Figure 4-4: Biowaste with water content <70%



When the organic waste is accepted at the facility, the weight should be measured. This allows to keep record of the daily waste intake of the facility. The best moment to measure the weight of the total incoming waste is after it has been shredded as then it is likely to be temporarily stored in containers. If dewatering of waste is practiced, then weigh the waste before and after the dewatering process.

4.1.2 BSF treatment unit

Waste treatment using larvae of the Black Soldier Fly can be conducted in many different ways. Here we describe a batch wise treatment with manual harvesting. Using this approach, a defined number of same-aged young larvae (5-DOL) are put in a container (incubator unit) with a defined amount of substrate. While the 5-DOL feed and grow, the incubator unit becomes too small to allow further growth and the larvae are then moved into a larger container (larvero unit) and more substrate is added.



As a rule of thumb, we work with the following numbers: 10,000 larvae are fed with a total of 12 kg of substrate (75% water content) and harvested after a total of 12 days. Initially the 10'000 5-DOL are kept in an incubator unit (30x20x10 cm) and left to feed on a single load of 1kg for 3 days, thereafter the larvae are transferred to a larvero unit (40x60x15cm) and left to feed on a single load of 11 kg for 9 days.

We propose to use the combination of incubator units and larvero units as this has shown to increase the amount of substrate that can be converted per unit of space available and also contributes to reducing the number of handlings. This approach involves starting with a larger number of smaller incubator units which are operated for 3 days and each receive small amounts of substrate. These smaller units allow easier handling without negatively affecting the growth of the young 5-DOL. We observed that using this "incubator" approach reduces overall labour time requirements and when harvesting at the end of the treatment process, the mixture of larvae and residue is dry enough so that it can be easily sieved.

For the second feeding, when the larger amount of substrate is added to the larvero units, two approaches are possible. Either bring the substrate to the larvero units or else move the larvero units to a central substrate feeding station. Installing a central substrate feeding station has the advantage of keeping the large bulk of waste concentrated in one location therefore keep the potentially filthy area in one spot (which can then be cleaned regularly) and avoiding movement of loose bulk waste around the facility. An additional advantage is that when moving the larvero units to the substrate feeding station each unit can be inspected and checked for irregularities. This book describes the feeding system when using a central feeding station.



The origin of BSF waste treatment

BSF research started in the mid-20th century in chicken barns. It was observed that the presence of BSF larvae in the manure underneath the chicken cages reduced housefly breeding and manure accumulation. Researchers, thus, started to put this new insight into practice by planning BSF friendly manure pits (ramps for prepupa self-harvesting, access for cleaning machinery and attached greenhouses for adults). Most of the attempts of taking BSF treatment to a professional level have been established around a continuously fed system based on prepupa self-harvesting. However, experience has shown that harvest losses and hygienic challenges are very high in a continuous system, making it difficult to operate it in an economically viable way.

As the larvae feed on the biowaste in the incubator and larvero unit, they will break down the organic matter and metabolize the nutrients into larval biomass. If too much biowaste is fed to the larvae, an unprocessed waste layer will build up and start to generate heat through its bacterial activity. This heat build-up is unfavourable for the larvae. The unprocessed waste layer will also attract vermin. On the other hand, if not enough waste is provided the larvae will starve and slow their growth. As a result the facility will have a lower waste treatment capacity and also lower yield of grown larvae. The amount of waste that can be fed per larvero unit is also limited by the resulting layer thickness of waste in the larvero. If the layer thickness of the waste in the larvero unit is thicker than 5cm, larvae will have difficulties to feed through this whole layer and the waste at the lower part of the layer will remain unprocessed.



The table manners of the larvae

The morphology of the mouthparts suggest that the larvae of *Hermetia illucens* specialize in liquid and small-grained foods. However, the larva also has a mechanism reminiscent of modern tunnel boring machines with which it can reduce coarse material with moving discs grinders going up and down four times per second and thus make larger particles accessible for digestion^{4,5}.

Following ingestion, the food passes through the food pipe into the midgut, the longest and most important part of the larva digestive tract. Along the midgut, through the combined action of the gut environment, enzymes, and microbes, the diet is broken down into smaller molecules for absorption through the gut cells into the haemolymph, the “blood” of insects⁶.

Microbes in the biowaste and larval gut have multiple functions that are important for the process performance. In the biowaste, microbes are important for the hydrolysis of biowaste macronutrients, especially fibres that typically cannot be decomposed by BSF larvae. After ingestion, some of these microbes are used by the larvae as food providing additional nutrients to those found in the diet.

- ⁴ Shishkov O, Hu M, Johnson C, et al. (2019) Black soldier fly larvae feed by forming a fountain around food. *Journal of The Royal Society Interface* 16.
- ⁵ Bruno D, Bonacci T, Reguzzoni M, et al. (2020) An in-depth description of head morphology and mouthparts in larvae of the black soldier fly *Hermetia illucens*. *Arthropod Structure & Development* 58.
- ⁶ Gold M, Egger J, Scheidegger A, et al. (2020) Estimating black soldier fly larvae biowaste conversion performance by simulation of midgut digestion. *Waste Management* 112.

Incubator and larvero units can be stacked upon each other to further reduce surface area requirements (Figure 4–5 and Figure 4–6). However, if stacked, it is suggested to keep enough open space between the stacked treatment units to allow for aeration. The gap between the units is necessary to secure air ventilation and to allow the moisture-saturated air above the units to be replaced. Ventilation also provides oxygen, which is crucial for the well-being of the larvae. For the incubator units, the single unit biowaste processing footprint is 33.3 kg/m²/d when stacking six units on top of each other (Figure 4–5). For the larvero units, the single unit biowaste processing footprint is 30.6 kg/m²/d when stacking six units on top of each other (Figure 4–6). When combining the system which uses incubator units for the first 3 days of feeding biowaste and stacking the units while the larvae are feeding, the combined biowaste conversion footprint of this system is 31.25 kg of biowaste treated per m² per day.



Figure 4–5: Rack with incubator containers (4 containers per crate)



Figure 4–6: Stack of larveros with ventilation frames in-between levels

4.1.3 Product harvesting

After 12 days of waste treatment by BSF larvae, each larvero unit is harvested. At this stage, the larvae have reached an age of 17 days and their maximum weight, but have not yet transformed into pre-pupae. Their nutritional value is, therefore, at its maximum. If this ideal moment is after 12 days of treatment, or a few days less or more, depends strongly on external influences such as the ambient temperature or the quality of the feed. Operators of a facility therefore need to remain vigilant and observe the larvae and their growth and change to identify the ideal moment of harvest specific to their local context and situation.

In the harvesting step, the two products larvae and residue need to be separated from each other. Depending on the water content of the input material, the residue will show as a crumbly dry mass or as a wet slurry. We do not recommend the wet slurry residue as the harvesting process becomes quite cumbersome. Therefore we recommend to take measures during the treatment step to ensure that the resulting residue will be a crumbly dry mass. When receiving waste substrates that are high in water content that would likely result in a wet slurry residue, we recommend adding a dry material such as cocopeat, palm kernel meal or milk powder during the treatment stage so that the residue has dried out by the time the larvero units are harvested. Dry crumbly residue can be harvested using a shaking sieve with two sieve layers, one with a mesh size of 3mm and one with a mesh size of 7mm. Shaking sieves can be manual or automated. Automated shaking sieves can achieve higher shaking frequencies than manual sieves and are, therefore, favoured (Figure 4–7). Sieving the larvae residue mixture with two sieve layers will result in a total of three fractions, one fraction of larvae and two fractions of residue (Figure 4–7). The first fraction of residue which has a dark soil-like colour can be bagged and stored until the material has matured and can then be used as a compost or soil amendment. The second fraction of residue, which is typically made up of leaves, seeds and other residual material, should be composted for a longer time, ideally using a windrow composting system.



To learn more about how to compost the BSF residue or in general organic matter, a composting guide can be found through this link



Figure 4–7: Shaking sieve to separate larvae from dry residue

During the shaking of the sieve, the coarse parts of the residue will remain on top of this first sieve layer with a mesh size of 7mm. The larvae and the fine parts of the residue will fall through this first sieve layer onto the second layer with a mesh size of 3mm. The larvae will remain on this sieve without falling through while the fine residue will fall through the second sieve layer. Given the inclination and the shaking of this type of sieve, all fractions move down the slope to the end of the sieve. Here, at each sieve layer level a funnel connects to a bucket where the fractions are collected for further processing. Other horizontal sieve systems use a vibrator engine to guide the material towards a funnel where it is collected in a bucket.



Figure 4–8: Three fractions of materials after sieving: 1 fraction of larvae and two fractions of residue

4.1.4 Conditioning of the harvested products

Harvesting separates the residue from the larvae. However, after completing the process some residue particles will remain stuck to the larvae and the gut of the larvae will still contain material which has not been excreted yet. Typically, the harvested BSF larvae are sold as animal feed products either alive or in a post-processed form. For both cases conditioning of the larvae is a requirement to increase the product purity and quality. Two ways of larvae conditioning are suggested here, which both aim to clean the larvae from remaining residue particles and partly reduce the larval gut content: purging and sanitising. While the purging operation cleans the live larvae, the sanitising operation kills the larvae in a blanching step prior to cleaning. Nevertheless, both described procedures do not necessarily fully free the larvae from microorganisms or any contamination which was in the waste source and might be transmitted to the larvae during their growth or contact with the waste substrate.

4.2 Activities in the BSFL conversion unit

In this subchapter, the process steps and the materials to use during these steps are presented. As with the BSF rearing operations, most materials can be found in hardware stores but some materials and equipment have been custom-made for the operation. The dimensions of these items are provided in the description under the item.



The technical drawings for the custom-made materials and equipment used in the operational steps of the BSFL conversion unit can be found through this link



4.2.1 Pre-processing

The goal of the pre-processing step is to reduce particle size and homogenise the input material. The waste can then easily be distributed and fed to the larvae and the nutrients are made easily accessible to the larvae and the associated bacteria.

Materials and equipment needed:



Hammer-mill shredder
(Cap 1 ton/h)



Bin
(80L)



Bulk scale
(max 150kg, acc 50g)



Mixer
(max cap 300kg)



Dry matter/TS oven



Dry matter analysis cup

Tasks:

Step 1: After a quality check and acceptance, remove the organic waste from the collection vehicle and place the waste near the shredder. While emptying the vehicle, remove non-organics contained in the waste (rough sorting).

Step 2 : Place a labelled bucket under the shredder outlet and turn on the shredder.

Step 3: While filling the hopper to shred the waste, manually remove non-organic components in the waste. When the waste receiving bucket is full, exchange it with a labelled empty new bucket.

Step 4: Weigh and document each full bucket of shredded waste using a bulk scale.

Step 5: After all waste is shredded, use the high-pressure washer to clean the inside, outside and around the shredder. All the wastewater needs to be discharged for treatment.



Step 1: Removing baskets with waste from the market. Baskets are checked one by one on content



Step 3: Reducing particle size of biowaste by shredding the material



Step 6 + 7: Conditioning of substrate by adding dry material if water content is too high and adding water if water content is too low

- Step 6:** If the waste substrate is still too moist (water content >80%) a dry bulk material has to be added to balance the water content and allow for the residue to be dry by the end of the process. You can mix the materials in with the substrate before feeding it into the conversion units using a mixer or simply add the dry material to the crates first and then add the wet substrate on top.
- Step 7:** If the substrate is too dry (water content <70), you can mix it in with a wet substrate or simply add water. Ensure that the dry material is always on the bottom and the wet material on top in case the material is not mixed before adding it into the larvero units.
- Step 8:** To find out what the water content of a waste material is, a Total Solids (TS) sample has to be prepared in a specifically designed oven. Normally these ovens are called "dry matter ovens" or "TS ovens".



PROTECTIVE MEASURES FOR WORKERS:

- Use gloves, protective clothing, eye and ear protection when using the shredder.
- Make use of the protective measures available for the shredder/hammer mill, i.e. feeding hopper, flap and other safety features, to avoid any risk of direct contact between workers' hands and moving parts.



POINTS OF MONITORING AND DATA COLLECTION:

- Weight of waste received
- Weight of separated fractions of waste for various destinations
- Before adding substrate to the larvero units, it is important to obtain substrate samples to determine the moisture content. For this purpose, thoroughly mix the substrate in each substrate holding container and place one large scoop from each substrate container into a bucket. Mix the content in the sampling container thoroughly and remove one sample of about 50g and place it onto a sample tray. The tray with the sample is weighed and then dried in an oven at 105 °C for 24 hours before weighing the tray again. Calculate the water content of the sample by: $\text{Water content [\%]} = (\text{Wet weight} - \text{Dry weight}) / \text{Wet weight} * 100$



The **pre-processing stage module from the e-learning video series** on BSF Biowaste Processing is available through this link.



4.2.2 Treatment

A new batch of biowaste for processing each day is initiated by setting up incubator units, feeding a defined amount of shredded (and conditioned) biowaste substrate into each of these incubator units, and then preparing and adding a defined number of 5-DOL on top of the substrate. Each incubator unit will receive 1kg of substrate and 10,000 5-DOL which results in a density of 3.3 larvae per cm^3 . Setting up larvero units involves preparing the empty larvero units by adding 11kg of fresh substrate and the content of a 3-day old incubator unit. This results in a density of 0.8 larvae per cm^3 . Layers of 6 larvero units are stacked on a pallet alternating with ventilation frames.

Materials and equipment needed:



Incubator unit rack
(150x180x65 cm)



Incubator unit
(30x20x10 cm)



Larvero unit
(60x40x15)



Larvero unit pallet
(129x122x20 cm)

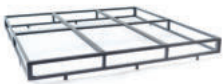

Ventilation Frame
(129x122x12 cm)



Biowaste conversion unit
(129x122x170 cm)



Pallet trolley
(cap. 2 ton)



Bin
(80 L)



Spade



Bulk scale
(max 150 kg, acc 50 g)



Trolley

Tasks:

- Step 1:** Prepare 36 empty incubator units and fill each with 1 kg of substrate
Step 2: Add one cup containing 10,000 5-DOL onto the substrate in each incubator unit



Step 1: Add 1 kg substrate to each incubator unit



Step 2: Add the portioned 5-DOL on top of the substrate

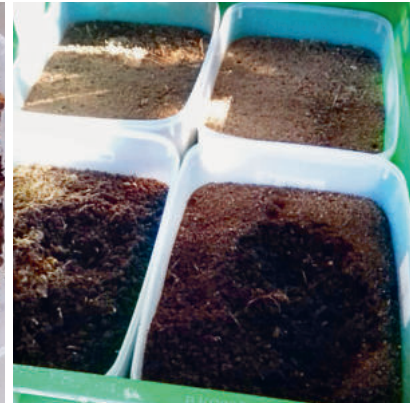

Step 3: Incubator units in crates

- Step 3:** Add the 36 incubator units into larger crates and add these crates into the incubator rack
Step 4: Take the oldest group of 36 incubator units from the incubator rack and place them near the feeding station
Step 5: Get a pallet and a pallet trolley. Prepare 36 larvero units and 5 open ventilation frames. Place these close to the feeding station.
Step 6: Place 6 larvero units on the pallet, feed them with 9kg of substrate each and empty one incubator unit into one Larvero unit on top of the fresh substrate. Place an open ventilation frame over the six crates. Now stack the next layer of six larvero units on the ventilation frame and repeat this process until a stack of six layers with a total of 36 crates is complete.
Step 7: Label the pallet with the pallet date code. Then, use the pallet trolley to bring the pallet to its destination in the building.
Step 8: Wash the substrate holding containers which have been emptied using a high-pressure washer and leave to dry.



Step 6: Stacking of the larvero units on the pallets



PROTECTIVE MEASURES FOR WORKERS:

- Use gloves and protective clothing during feeding activities



POINTS OF MONITORING AND DATA COLLECTION:

- Weight of substrate added to incubator units
- Weight of substrate added to larvero units



The **treatment stage module from the e-learning video series** on BSF Biowaste Processing is available through this link.



4.2.3 Harvesting

After the larvae have fed on the substrate and only dry residue remains, the Larvero units are harvested using a mechanical sieving system which allows for the mixture of residue and larvae to be separated into three fractions. The larvae can then be removed and further processed. The residue streams undergo further treatment before being applied to soils.

Materials and equipment needed:



Conveyor (custom made) **and separation system** (Guan-Yu, GY-1000-2S). Sieve with dimensions of 100x100x106 cm, 2HP dynamo with voltage of 380 (3-phase) and 1440 rpm



Bin
(80L)



Spade



Bulk scale
(max 150kg, acc 50g)



Trolley



Dry matter/TS oven



Dry matter analysis cup

Tasks:

- Step 1:** Prepare the harvesting area by placing empty material bins under the outlets of the sieving machine and placing the bulk balance near the hopper of the conveyor belt.



Step 1: Harvesting station with sieving system, collection bins and residue bags

- Step 2:** Select the pallet or pallets that will be harvested on this day, by checking the set-up/harvesting schedule, and move it/them to the harvesting area using the pallet trolley
- Step 3:** Turn on the bulk balance, conveyor belt and sieving machine
- Step 4:** Take three empty conversion crates and tare their weight on the bulk balance. Then take the first three larvero units with a mixture of residue and larvae from the pallet and place them on the bulk balance. Note down the mass in the log sheet.



Step 4: Weighing crates from the biowaste conversion unit on a scale

- Step 5:** Empty the three larvero units one-by-one into the hopper so that the material gradually is transported into the top of the sieve by the conveyor.
- Step 6:** Repeat the processes of weighing, noting down the weight and emptying the units until one pallet is harvested. Then repeat the process for the other pallets that are scheduled to be harvested today
- Step 7:** While harvesting the pallets: ensure you keep each of the three output fractions separate for each pallet to obtain harvesting yield per pallet. Switch bins with empty ones when full.

Step 8: One output fraction will have larger particles, the content of this bin is weighed and noted down and the material is composted. Another output stream is the fine residue, the content of this bin is weighed and noted down and the material is bagged for maturing.

Step 9: The third fraction are the larvae which are still mixed with some residue with a particle size similar to the size of the larvae. The residue is removed by skimming it off (by hand) from the top of the bin as larvae are pushing up the residue to get away from the light. After no clusters of residue can be observed, the bin with larvae can be weighed and the weight noted down.



Step 7: Larvae and residue on transport belt before being separated into the different fractions



PROTECTIVE MEASURES FOR WORKERS:

- Use gloves, eye protection and protective clothing during harvesting activities.



POINTS OF MONITORING AND DATA COLLECTION:

- It is critical to measure the weight of the “harvest” of the residue and the larvae. These data are used to calculate performance indicators that allow the operator to monitor the performance of the treatment facility, namely waste reduction, bioconversion ratio and larval yield. For this purpose, we measure the net weight of the larvero content as well as the larvae harvest. The difference between net larvero content and larvae harvest is the weight of the residue. Furthermore, we analyse the residue with regard to its water content.
- Document the weight of each larvero before emptying. Subtracting the weight of the empty larvero container will result in the net weight of the larvero content.
- Document the total weight of harvested larvae.
- After harvesting the larvero units, it is important to obtain samples from the residue and the larvae to determine the mass and moisture content. For this purpose, remove batches from three random Larvero units and place the samples in cups. Put the sampling bowl onto a plate and pick out all the larvae. Make sure to not spill the liquid as this is part of the wet weight measurement.

Once you take out all the larvae, put the residue into a sampling tray. Take 20 of the larvae and dry them with a tissue before putting them onto a sampling tray. Repeat this three times for the three samples. Put the rest of the larvae back to the harvested crates or directly on the harvesting screen. Weigh the samples (larvae and residue) and dry them in an oven at 105 °C for 24 hours before weighing each tray again. By doing this, you will obtain the water content of the larvae and the residue. Calculate the water content of the sample by: $\text{Water content [\%]} = (\text{Wet weight} - \text{Dry weight}) / \text{Wet weight} * 100$



Separating residue from larvae and taking random larvae for triples samples



Triplet samples of substrate in, residue out and larvae out are placed in the TS oven



The **harvesting stage module from the e-learning video series** on BSF Biowaste Processing is available through this link.



4.2.4 Conditioning

Harvested BSF larvae should either be purged or sanitised, depending on the intended use of the larvae.

Purging:

Purging starts with a washing step to remove the remaining residue attached to the larvae. Then the washed larvae are left in a purging bed containing a dry material for a period of three to four hours. During this time, larvae will start emptying their gut content. After purging, larvae are still alive and therefore this process is good practice when selling live larvae.

Materials and equipment needed:



Bin for washing



Washing net



Plastic tube rack



Water



Bulk scale
(max 150kg, acc 50g)



Dry cocopeat



Purging bed



Sieve
(mesh size: 3 mm)

Tasks:

- Step 1:** Prepare the washing bin. Place the plastic tube rack inside the waste bin. Place the washing net inside the waste bin and fix it on the side.
- Step 2:** Washing. Add 10 kg of freshly harvested larvae on the net. Wash the larvae with clean water until all remaining dirt and residue is washed of. This may take 5 to 10 minutes.
- Step 3:** Purging. Place the wet larvae on the purging bed. Add for every 10 kg of wet larvae 1 kg of dry material, e.g cocopeat. Mix the cocopeat with the larvae and leave the larvae for three to four hours.
- Step 4:** After few hours you will see that the larvae have dried off and started to separate from the cocopeat. Remove the remaining cocopeat by sieving the larvae.



Step 1: Preparation of washing bin.



Step 2: Washing of larvae



Step 3: Larvae in a purging bed.



Step 4: Larvae separated from cocopeat.



PROTECTIVE MEASURES FOR WORKERS:

- Use gloves, eye protection and protective clothing during grinding activities.



On sanitising larvae

It is obvious that insect larvae fed with organic waste may pose a health risk when fed to livestock if they are left untreated. Thermal treatments such as boiling, roasting, (deep-)frying, blanching and microwave treatment, even for short times, have proven to be very effective to reduce the amount of vegetative bacteria and fungi. The application of heat to whole insects after harvesting allows most microbial counts to be reduced to below detection limit. However, it was also found that at least some of the bacterial endospores can survive a heat treatment and thus it can lead to recontamination in the further process⁷. The traditional processing techniques of solar drying seem to have little effect on the reduction of bacteria, yeast and mould⁸. Therefore, regardless of the treatment method, care must be taken to minimise the risk of recontamination by maintaining a hygienic working environment during further processing.

⁷ Vandeweyer D. (2018) Microbiological quality of raw edible insects and impact of processing and preservation. 197.

⁸ Nyangena D, Mutungi C, Imathiu S, et al. (2020) Effects of Traditional Processing Techniques on the Nutritional and Microbiological Quality of Four Edible Insect Species Used for Food and Feed in East Africa. *Foods* 9: 574.

Sanitising:

For the sanitising step the larvae are dipped in boiling water (blanching) for 60 seconds. Blanching kills the larvae quickly and as a reaction to the sudden increase in temperature – due to the dipping in the boiling water - larvae empty part of their gut content. Thereafter the following washing step, washes off remaining residue and gut content from the larvae. After this step, we recommend to further process the larvae as fast as possible, as the dead larvae spoil quickly. Sanitising facilitates subsequent drying, as larvae have thus already been killed and do not move around anymore during the drying step. Moreover, the quicker the killing, the better for the animal and also for the end product, as stress can negatively influence the product quality.

Materials and equipment needed:



Bin for washing



Washing net



Plastic tube rack



Water



Pot for hot water



Stove setup



Dipping spoon

Tasks:

- Step 1:** Preparations. Heat up the water until you see bubbles rising or until it reaches a temperature of 90°C. In the meantime prepare the washing bin, by placing the plastic tube rack inside the bin and fixing the washing net on top.
- Step 2:** Sanitising. Fill the dipping spoon with freshly harvested larvae and dip them into the hot water for around 60 seconds. Then transfer the larvae on to the prepared washing net. Repeat this step until the washing net is full of larvae (approximately 10kg). Exchange the dirty water with clean water every 50kg of larvae.
- Step 3:** Washing. Clean the blanched larvae with clean water until the remaining residue is washed off.
- Step 4:** Directly start post-processing the larvae, as in this state the larvae will decompose very fast. If post-processing is not possible, store the sanitised larvae in the freezer.



Step 1: Preparation of washing bin.



Step 2: Dipping of larvae in hot water.



PROTECTIVE MEASURES FOR WORKERS:

- Use gloves, eye protection and protective clothing.



The **conditioning module from the e-learning video series** on BSF Biowaste Processing is available through this link.



4.3 Work schedules, monitoring and data collection

The activities covered in this chapter all relate to the conversion of the biowaste using the Black Soldier Fly Larvae. As with the rearing unit, the amount of handlings can make this system complex to operate. A work schedule is available (see Annex C) which structures all the handlings in a step-by-step way and thereby creates an organised overview of which steps have to be passed through each day.

In the described operations as well as in the work schedule, there are moments when data needs to be collected and recorded in order to create an overview of the rearing cycle performance. The rearing operations used one log sheet for all operations in the rearing unit. However, as the treatment unit is much larger and the different operations are quite far spread out over the site, separate log sheets are prepared and placed at the different locations so that the operator can fill out the data log sheets close to where the tasks are being conducted. The log sheets are available in Annexes E and F. The log sheets allow recording of data on waste in, waste to treatment, waste in units, larvae out and residue out of units and dry matter sample results. The way to collect this data is explained in the respective stages in the chapters above.



Chapter 5:

BSFL post-processing and Marketing

5.1 Marketable Products from BSFL Biowaste Conversion

Processing organic waste using BSFL results in two main outputs: Larvae (10-20% of the waste's wet weight) and frass (20-40%). The frass can be further processed by composting into soil-enhancing compost. Similarly, the larvae can be directly sold as fresh larvae or they can undergo further processing into products like dried larvae (pop larvae), BSF meal, BSF oil or BSF pellets (Figure 5-1). All of these products are potential revenue streams for a BSF biowaste conversion facility.

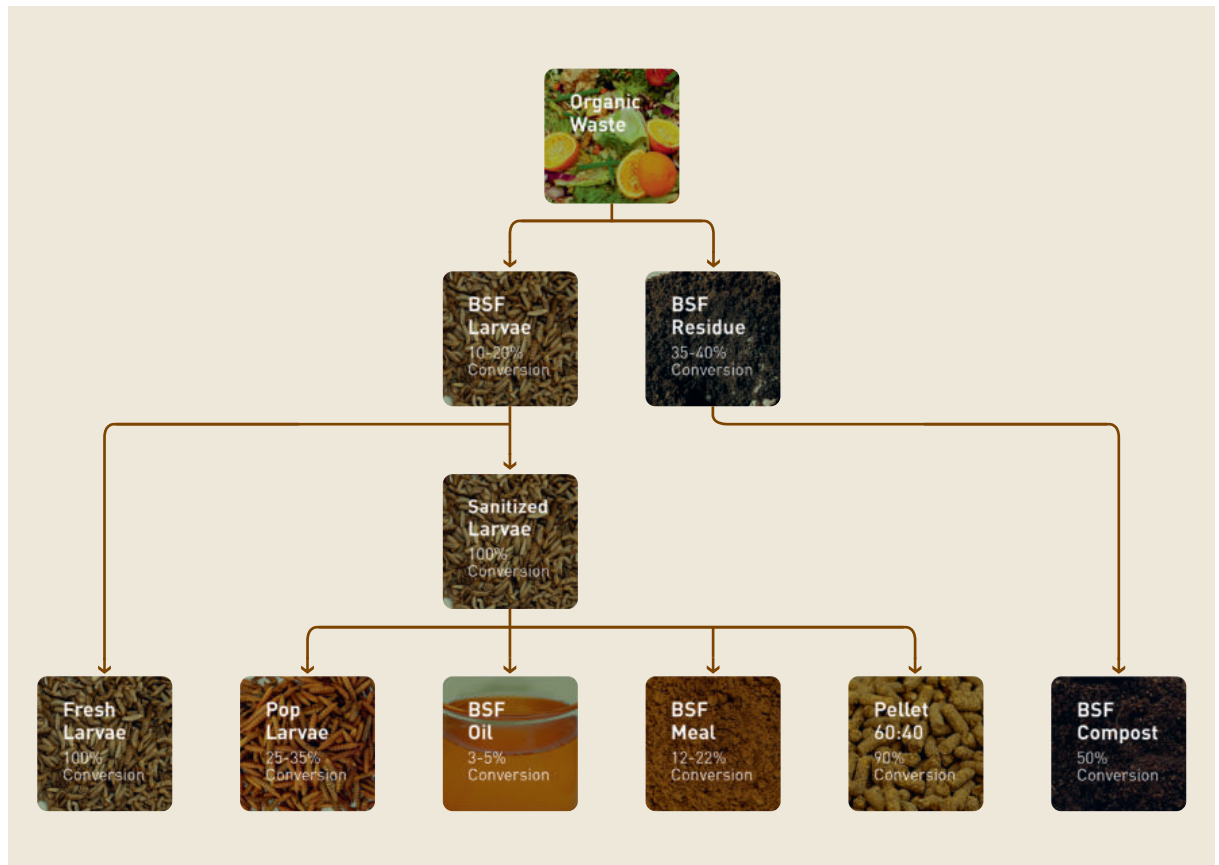

Figure 5-1: BSFL waste conversion products. Conversion percentages describe the estimated yield from the previous product. Values are based on wet weight.



Another revenue stream could be from products of the BSF rearing unit, e.g. BSF eggs, 5-DOLs or BSF pupae. BSF rearing products are interesting for other BSF facilities or BSF newcomers. These are usually sold at low sales volumes due to the limited market opportunities but are sold at high sales prices.



The use of frass

In comparison to the application of maggots as animal feed, research around the use of the frass is not so advanced. However, growth trials with various agricultural crops show promising results when frass is used as a soil amendment. Whether as a soil conditioner, substitute for synthetic fertilizer or to replace peat in horticulture, frass seems to be suitable regardless of the initial feedstock and whether it underwent a composting process before application or not^{9,10,11}. The suitability of fresh frass has also been tested for biogas production where results show that biomethane potentials similar to conventional substrates used in anaerobic digestion, with slightly higher levels than expected from cattle manure but lower than expected values from food waste¹².

Studies show that frass can also be used as a substitute for the plant-based ingredients in fish feed. Good growth rates were achieved in feeding trials with catfish or tilapia. The initial feedstock is of course of great importance in this case. Use of frass in tilapia diets may even prove beneficial by improving innate immune components and the resistance of tilapia against bacterial infection¹³.

- ⁹ Menino R, Felizes F, Castelo-Branco M, et al. (2021) Agricultural value of Black Soldier Fly larvae frass as organic fertilizer on ryegrass. *Heliyon* 7: e05855.
- ¹⁰ Setti L, Francia E, Pulvirenti A, et al. (2019) Use of black soldier fly (*Hermetia illucens* (L.), Diptera: Stratiomyidae) larvae processing residue in peat-based growing media. *Waste Management* 95: 278-288.
- ¹¹ Beesigamukama D, Mochoge B, Korir NK, et al. (2020) Exploring Black Soldier Fly Frass as Novel Fertilizer for Improved Growth, Yield, and Nitrogen Use Efficiency of Maize Under Field Conditions. *Frontiers in Plant Science* 11.
- ¹² Elissen HJH, Hol S and van der Weide R. (2019) Methane production from insect, worm and mushroom waste streams and combinations. Wageningen University & Research.
- ¹³ Yildirim Aksoy M, Eljack R, Schrimsher C, et al. (2020) Use of dietary frass from black soldier fly larvae, *Hermetia illucens*, in hybrid tilapia (Nile x Mozambique, *Oreochromis niloticus* x *O. mozambique*) diets improves growth and resistance to bacterial diseases. *Aquaculture Reports* 17: 100373.

Marketing of BSFL products

One option is direct marketing of fresh larvae to customers. As the larvae will continue to develop even after harvest and quickly turn into pre-pupae and pupae, immediate transport and feeding is required. No additional processing costs are required. Thus the sales price is lower but may include additional delivery costs. Potential clients are for example chicken or fish farmers that are located in proximity of the BSF biowaste treatment facility. To have a steady income, a good network and organisation with farmers is essential, so larvae are picked up (or delivered) on a daily basis and losses are minimized.



Replacing up to 30% of commercial chicken feed or up to 50% of commercial catfish feed results in a similar or better growth performance of the animals. Based on BSFL and commercial feed prices in 2021, replacing commercial feed with BSFL is cost saving. For the details, check our fact sheets.



Chicken



Catfish

Post-processing facilitates storage and transport and hence, marketing activities of BSFL products. These benefits raise the sales prices of BSFL products and fluctuating demand can be buffered. At the same time, post-processing raises the operational costs. Therefore, for a successful business, selecting the right target market is crucial.

If your main revenue stream is from selling larvae, we recommend to perform a market assessment before you start with your BSF business. Typically there are two main market directions: the farmed animal feed and the pet food sector. It helps to investigate potential markets by performing the following tasks:

1. Define potential substitute products
2. Quantify the market size of these substitute products (sales volume in kg per month)
3. Quantify the market value of substitute products (sales volume in USD per month)
4. Check the price range of most popular products in the market
5. Check for regulations that apply for products

Potential substitute products are products which are similar to BSFL products such as other insect based products or pellets containing soy or fishmeal, which could be replaced by BSF meal. Depending on the market environment, a lot of information can be found online. For more informal markets, it can help to directly talk to retailers in the market.



We performed a market assessment for East Java, Indonesia, where we were looking at the poultry and aquaculture feed sector as well as the local pet food market. Methodology and results are described in a detailed report.



Gate fee as an additional income

One source of possible income for organic waste treatment facilities in general and for BSF facilities in particular is by collection of a “treatment” fee. This is comparable to the tipping fee at a landfill, where a fee is charged for accepting waste. Depending on the level of the fee, this can have a strong impact on the competitiveness and financial viability of the BSF plant, as it can subsidize production costs. Nevertheless, the quality of the delivered waste must still be guaranteed and ensured in order to avoid significant contamination or the additional costs of a necessary waste sorting step. The rates of such treatment fees or gate fees vary greatly from region to region. Composting facilities in low- and middle income countries for example charge between 5.– and 50.– USD/ton of waste they accept at the gate. Increased demand for a particular waste material can also have a strong impact on prices. In Germany, gate fees have fallen from 50.– USD/ton to zero in regions where some waste management sites compete for organic waste.



A case study for Surabaya shows the market potential of various BSFL products in the pet food market. Find all details in our factsheet.





Various BSFL products have been tested on ornamental fish and ornamental birds. Results indicate that BSFL products can compete with conventional pet food products in terms of quality and price. Find all details in our factsheet.



BSFL products

Based on the market study, several BSFL products may have the potential to create revenue. The quality and use of BSFL products depends on the extent of further processing. Whereas fresh larvae are not further processed, dried larvae require a drying step and BSF meal and oil require a fractioning and refining step in addition to the drying step. Table 5–1 gives an overview of BSFL products, post-processing steps required, application and quality parameters including water activity, shelf life and nutritional parameters. Water activity is a measure for the free water in the product that is available for microorganisms. A water activity lower than 0.6 inhibits growth of any bacteria and yeasts. Low water activities and low fat contents prolong the shelf life of BSFL products. BSFL mainly consist of proteins and fats, which is why only these nutritional parameters are listed in the table. For protein and fat content a range is given, as these parameters depend on the waste source used to feed the larvae. Especially the fat content can vary greatly between 20 and 40% in dried larvae, which then also has an effect on the protein percentage of the dried larvae. Fresh larvae and dried larvae can be applied directly as feed products, whereas BSF meal and BSF oil are ingredients for, for example, feed pellets.

Table 5–1: Overview of BSFL products



Product	Fresh larvae	Dried larvae	BSF meal	BSF oil
Process	None	Drying	Drying + Fractioning	Drying + Fractioning
Protein %*	6 – 10	30 – 40	50 – 65	0
Fat %*	6 – 10	20 – 40	8 – 15	100
Water activity	0.9	0.4	0.3	-
Expected shelf life	1–2 days	4 month	6 month	2 month
Transport/Storage	Open box	Sealed packaging	Sealed packaging	Sealed packaging
Application	Direct feed	Direct feed	Raw material	Raw material

* values are based on wet weight

Drying

Removal of water and thereby reducing water activity to 0.4 (which is well below the upper limit of 0.6 as mentioned above) inhibits microbial and enzymatic activity and makes the product storable for up to 4 months. By evaporation of water, the remaining nutrients in the product become more concentrated, which means dried larvae have a higher protein content per sellable weight compared to fresh larvae.

Dried larvae can be sold directly as a feed product. Visual aspect of dried larvae is one key aspect that can determine its market value, especially for the pet food market. Characteristic colour, texture and shape of dried larvae depend on the drying technique applied. Here, four different drying methods are introduced, which can be categorized into rapid and slow drying. During rapid drying, the water within the larvae evaporates quickly, which leads to a pressure build-up within the larvae and ultimately to an instantaneous pressure release resulting in puffed and crispy larvae or so called “pop-larvae”. Microwave drying or roasting are rapid dehydration methods and result in pop-larvae. Roasted larvae typically show a darker colour (see Figure 5–2). The darker colour results from heat induced reactions in the roasting process which include colour changes. In contrast, microwaving is gentler and only minimal heat induced reactions take place and pop-larvae maintain a pale yellow colour. During slow dehydration processes like oven drying, the water evaporates slowly and the larvae shells shrink steadily until a constant weight is reached. The product is less voluminous, and its texture is hard and stiff (see Figure 5–2). The more bulky and voluminous product obtained by rapid dehydration has proved to look more appealing to most customers and thus has a higher market value.



Figure 5–2: Dried larvae products

Besides the different visual appearance of the dried products, drying methods are also distinguishable in terms of process parameters, which are listed in Table 5–2. Microwave heating requires an electricity connection but is an energy efficient and simple process. Here we describe the process of microwave heating using a simple kitchen microwave, which is good for small scale applications as it requires minimal investment and space. However, also industrial microwaves are available, which require a larger investment but allows processing of larger batches. Similar to coffee beans or nuts, BSFL can be roasted in a drum dryer. A drum dryer is fitted with a well heat insulated drum, an exhaust-fan, a fin structure inside the drum to flip the larvae as well as an efficient burner to heat the drum from the bottom. A small-scale alternative to a drum dryer is sand roasting in a wide wok pan, similar to the widely used sand-roasting technique of street food vendors in Asian and Sub-Saharan countries making value-added snacks from cereals or nuts. The sand prevents burning and facilitates even heating as it functions as a heat transfer medium. Compared to roasting in a drum, energy usage is less efficient when roasting in open wok pan. When using an oven, larvae are slowly dehydrated at 65°C. This rather low temperature drying prevents the loss of valuable nutrients and avoids baking or burning of the larvae. A benefit of oven drying is its passive operation, which reduces labour requirements.

Table 5-2: Process related parameters of different drying methods



Parameter	Microwave drying	Roasting (drum)	Roasting (pan)	Oven drying
Energy source	Electricity	Gas	Gas	Gas
Heat medium	Electromagnetic waves	Hot air	Sand	Hot air
Material temperature	Max. 180°C	Max. 140°C	Max. 180°C	Max. 65°C
Batch size	0.25 kg	5 kg	1 kg	30 kg
Drying time	15 minutes	40 minutes	20 minutes	24 hours
Throughput	1.0 kg/h	7.5 kg/h	3.0 kg/h	1.3 kg/h
Space usage	0.4 m ²	2.5 m ²	0.4 m ²	2 m ²
Energy usage/kg dried larvae *	3.7 kWh	8.2 kWh	12.2 kWh	10.9 kWh

* Energy usage is presented as kWh. 1 kg gas equals 13.6 kWh.

Fractioning and refining

The high fat content of dried larvae may be unfavourable, since standardized animal feeds usually require a fat content below 10%. Moreover, a high fat content makes the product more susceptible to lipid oxidation, which can result in unpleasant flavours and textures. Also, further processing of dried BSFL into pellets or other processed products may be difficult, as high amounts of fat can cause smearing and blocking of machines. The fat in the dried larvae can be extracted mechanically using a screw press typically used for nuts and seeds. This process is called fractioning, as the larvae are split into a protein fraction (BSF meal) and fat fraction (BSF oil). In a first step, the screw press squeezes the fat out of the larvae and produces a press cake and a press liquid. A second refining step then yields BSF meal from the press cake and BSF oil from the press liquid. Because of its high protein content, BSF meal is a potential substitute for fish meal or soybean meal. BSF oil contains valuable fatty acids and can be a potential alternative for coconut or palm kernel oil. Fractioning further enhances the shelf life of the BSF meal by up to 6 months. Both BSF meal and BSF oil are raw materials, which can be used for different end-products and can be further processed via pelletizing or saponification.



Wet-processing is when BSFL are pressed without prior drying, using a nut screw press. Find details for this process in our factsheet.



For feed formulation with BSF meal, it is especially the protein quality that is important to consider. The protein quality depends on the amino acid content. Amino acids are the building blocks of proteins and each animal requires specific amounts of certain amino acids in their feed for a healthy development. Protein sources such as fish meal or soybean meal have different amino acid contents than the amino acid profile of BSF meal. When formulating feed using BSF meal it helps to analyse amino acid contents and compare it to commonly used protein sources like fish meal.

The quality and application of BSF oil depends on its fatty acid composition, as each type of oil consists of different fatty acids. BSF oil typically contains high amounts of lauric acid, which makes it comparable to palm kernel oil or coconut oil. The fatty acid composition is influenced by the waste source used to feed the larvae. These differences in fatty acid composition can become visible in the oil consistency. Thus, BSF oil may be in solid or liquid form at room temperature depending on the fatty acid composition.



An example of an amino acid and fatty acid analysis and how they compare to other protein sources, and other oils respectively, are described in our factsheet.



Due to the similarities of BSF oil to coconut oil, it could be used as an ingredient to make a soap bar. Find all the details on how to make a soap bar in our factsheet.



5.2 Activities in the post-processing unit

Figure 5–3 illustrates the flow diagram of the post-processing options and the mass balances for each processing step. Sanitised larvae contain around 75% water and protein and fat account each for around 10% of the wet weight. In the drying step, the water is evaporated, which results in a mass reduction of around 70%. Remaining nutrients become more concentrated resulting in a protein content between 30 and 40% and a fat content between 20 and 40% of dry weight. By fractioning, the dried larvae are pressed into a press cake (around 70%) and crude BSF oil (around 20%). During hot pressing some remaining water evaporates (around 10%). The press cake is then grinded to a fine meal. During this refining step the mass balance does not change, as only the particle size is reduced. Refining of BSF crude oil further reduces the oil mass by 40%, as solids in the oil are filtered out. Each of the processing steps are further explained in detail within this chapter.

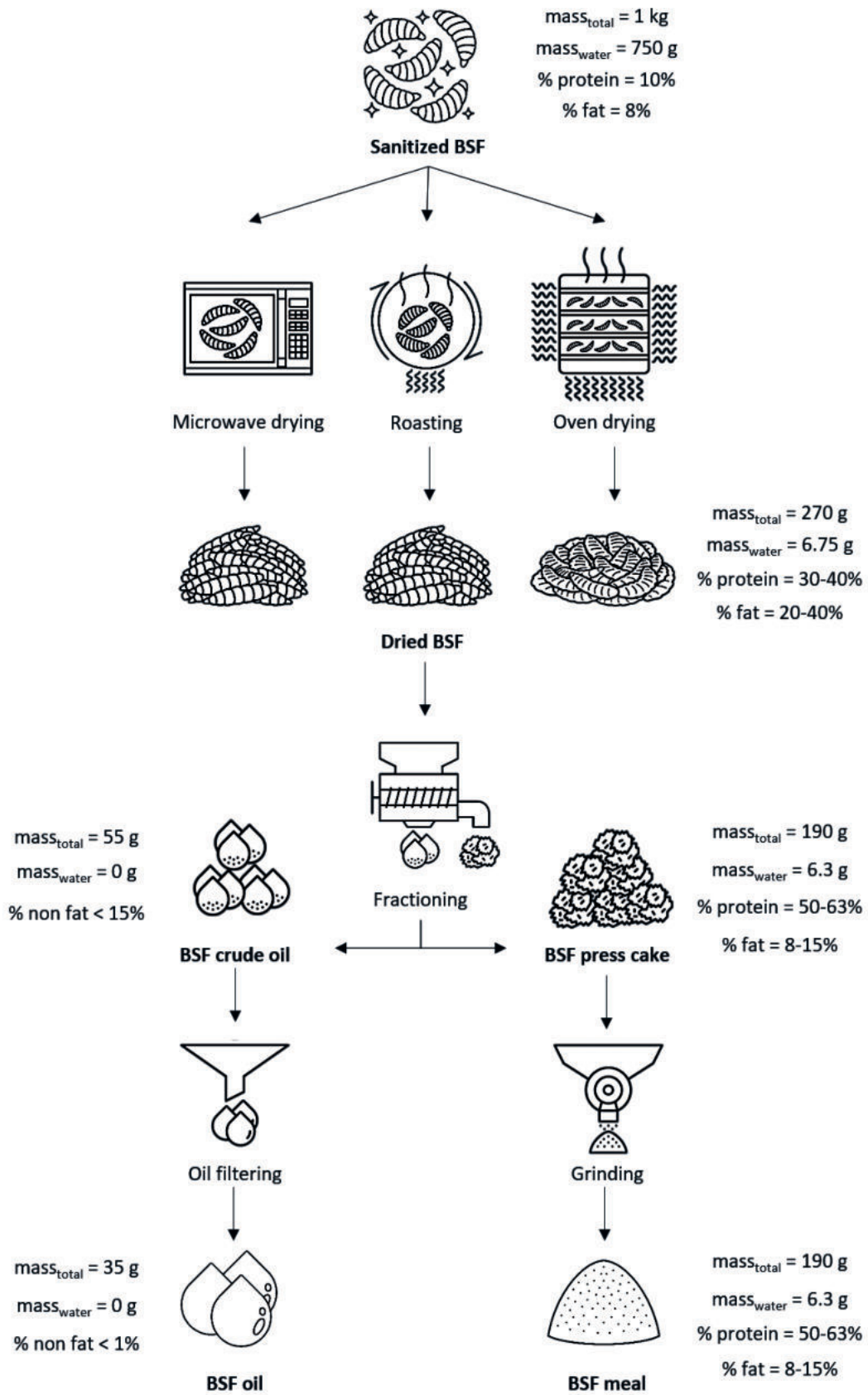

Figure 5-3: Process flow diagram and mass balance of post-processing BSF larvae.

5.2.1 Microwave Drying

We illustrate the microwaving operation with a simple kitchen microwave. However, the same principles as described here are also applicable for larger scale microwaves.

Materials and equipment needed:



Microwave
32 L, 1000W
Capacity: 1 kg/h



Ceramic plate



Bulk balance
Max. capacity: 35kg
Accuracy: ± 0.5 g



Heat resistant gloves



Storage container



Flipping spoon

Tasks:

Step 1: Weigh 250 g of sanitized BSFL on to a ceramic microwave safe plate and distribute the larvae evenly.



Step 1: Larvae evenly distributed on the plate.



Step 2: Timer set to 5 min.

Step 2: Place the plate into the microwave and start to dry in 3 cycles of 5 minutes - at the highest power (1000 Watt). In between each 5 minute cycle open the microwave for 30 seconds, let the steam escape and flip the larvae with the flipping spoon. Too much steam in the microwave can cause damp and moist larvae, and also drying takes longer if you do not let the steam out. During the last cycle you will hear the typical «popping» sound.

Step 3: Check if the product quality matches the following 2 indicators:

- Indicator 1: the larvae have a puffed shape
- Indicator 2: the larvae have a crispy and dry texture. When you crush the larvae with your fingers, it breaks easily apart into fine crumbles.

If these indicators are not met, and your larvae are still moist or damp just re-start the microwave for an additional cycle of 2-3 minutes – at highest power. When both indicators are achieved, remove larvae from the microwave.

Step 4: Weigh the dried larvae of each batch and note down the weight in the log sheet (see Annex F). Let the pop-larvae cool before you store them in a closed container. Label the container with the production date.



Step 3: Checking the larvae texture.



Step 4: Weighing and storing the dried larvae.



PROTECTIVE MEASURES FOR WORKERS:

- Use gloves, eye protection and protective clothing during microwaving activities.



POINTS OF MONITORING AND DATA COLLECTION:

- Measure the weight of the larvae per batch before and after drying and note it down on the log sheet.



The **microwave drying module from the e-learning video series** on BSF Biowaste Processing is available through this link.



5.2.2 Roasting

The roasting operation is described based on a coffee roasting machine produced in Surabaya, Indonesia. The process will work similarly for other rotating dryers. When buying or building a drum dryer it is important that the machine is fitted with a good heat insulated drum, an exhaust-fan, a fin structure inside the drum to flip the larvae as well as an efficient burner.

Materials and equipment needed:



Coffee Roaster

Motor: 350W
Exhaust fan: 700W
Drum volume: 0.46m³
Capacity: 7.5kg/h



Gas cylinder



Heat resistant gloves



Bulk scale
Max. capacity: 150kg
Accuracy: ± 50g



Container (60x40x12 cm)



Storage container

Tasks:

- Step 1:** Get the drum dryer ready for operation. For that, attach the gas cylinder to the burner of the drum dryer and connect the machine to electricity. Switch on the control panel of the machine and start the rotation, the exhaust fan and the heating. Set the temperature to 140°C, and preheat the drum while it is rotating and the exhaust fan is on.
- Step 2:** As soon as the temperature has reached 140°C, add 5 kg of larvae to the drum via the inlet funnel. Let the larvae roast for approximately 40 minutes in total. You will notice that the temperature will drop at the beginning to around 80-90°C. As more and more water then evaporates, the temperature will start to rise again – this is when the actual roasting process starts. You can check the process, by removing a sample from time to time.



Step 2: Adding larvae to the drum via funnel.



Step 3: Emptying drum via front flap door.

Step 3: Stop the process when the following two indicators are met:

- Indicator 1: the larvae need to have a puffed shape
- Indicator 2: the larvae need to have a crispy and dry texture. When you crush the larvae with your fingers, it breaks easily apart into fine crumbles

These indicators are usually met after the dryer has been operating for 5-10 min after the temperature has reached 140°C again. Remove the larvae from the dryer by opening the front flap door.

Step 4: Weigh the dried larvae per batch and note down the weight on the log sheet. Let the pop-larvae cool before you store them in a closed container. Label the container with the production date.



The **drum roasting module from the e-learning video series** on BSF Biowaste Processing is available through this link.

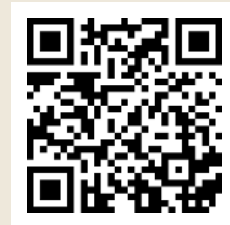

A small scale alternative to drum roasting, which also considers very limited resources available, is the sand roasting technique using a wok pan. The ideal sand for this method is washed beach sand with a particle size from 0.8-1.5 mm. We recommend changing the sand after 5 cycles of drying. Burned and dark sand results in burned and dark larvae.

Materials and equipment needed:



Wok pan setup
Diameter pan: 30 cm
Capacity: 3 kg/h



Mesh spatula



Spatula



Heat resistant gloves



Storage container



Washed beach sand
Particle size: 0.8-1.5 mm



Bulk balance
Max. capacity: 35 kg
Accuracy: ± 0.5 g



Lighter

Tasks:

- Step 1:** Add 1 kg of sand to the wok pan, turn on the gas stove and pre-heat the sand for 15 min.
- Step 2:** Add 1 kg sanitised BSFL to the sand and roast the larvae for 15 to 20 minutes while you are continuously stirring. During the last 5 minutes you will see the larvae puff and you will hear the typical popping sound. You will notice the end of the process when the «popping sound» is less frequent.



Step 1: Preheating 1 kg sand in a wok pan.



Step 2: Adding 1 kg of BSFL to the hot sand.

- Step 3:** Stop the process when the following two indicators are met:
- Indicator 1: the larvae need to have a puffed shape
 - Indicator 2: the larvae need to have a crispy and dry texture. When you crush the larvae with your fingers, it breaks easily apart into fine crumbles
- If these indicators are not met and your larvae are still moist or damp, continue stirring and roasting

Step 4: Remove the larvae from the pan using the mesh spatula and weigh the dried larvae per batch and note down the weight in log sheet. Let the pop-larvae cool before you store them in a closed container. Label the container with the production date.



Step 4: Removing dried larvae from wok pan using a mesh spatula. Shaking the mesh spatula removes sand attached to the larvae.



PROTECTIVE MEASURES FOR WORKERS:

- Use oven gloves, eye protection and protective clothing during roasting activities.



POINTS OF MONITORING AND DATA COLLECTION:

- Measure the weight of the larvae per batch before and after drying and note it down on the log sheet.



The **sand roasting module from the e-learning video series** on BSF Biowaste Processing is available through this link.



5.2.3 Oven Drying

In a simple gas heated oven, as shown here, air circulation is not enough to ensure even heat distribution for drying. Therefore, it is important to shuffle trays inside the oven as this helps to ensure even drying. Typically, BSFL on the trays close to the bottom and top dry faster than on the trays in the middle. Therefore, shuffle the trays from top or bottom towards the centre of the oven. Ideally it would be even better to install a fan inside the oven, which ensures even heat distribution throughout all areas inside the oven.

Materials and equipment needed:



Oven with thermostat
Thermostat: TGW IL-80EM
Heating: Stove (RI 511A)
Capacity: 1.3kg/h



Bulk scale
Max. capacity: 150 kg
Accuracy: ± 50 g



Mesh trays
Mesh size: 4 mm
Dimensions: 65x45x3.5 mm



Gas cylinder



Heat resistant gloves



Storage container

Tasks:

- Step 1:** Start the oven by connecting the gas cylinder to the stove of the oven, start heating the oven and set the thermostat to 65°C.
- Step 2:** Add 3 kg of sanitized larvae to each of the 10 mesh trays and insert them into the pre-heated oven. The larvae are dried during one first and long night session of 16 hours, a morning session of 4 hours and a last afternoon session of 4 hours. In between these three sessions trays are shuffled.



Step 1: Setting the thermostat to 65°C.



Step 2: Adding the mesh trays with sanitised BSFL to the oven.

Step 3: Stop the process after 24 hours of drying and check if the following indicators are met:

- larvae have a hard and dry texture
- larvae have a flat and shrunken shape

Step 4: Weigh the dried larvae per batch (sum of all trays) and note down the weight in the log sheet. Let the larvae cool before you store them in a closed container. Label the container with the production date.



PROTECTIVE MEASURES FOR WORKERS:

- Use oven gloves, eye protection and protective clothing during oven drying activities.



POINTS OF MONITORING AND DATA COLLECTION:

- Measure the weight of the larvae per batch (sum of all trays) before and after drying and note it down on the log sheet.



The **oven drying module from the e-learning video series** on BSF Biowaste Processing is available through this link.



5.2.4 Fractioning

The fat of the dried larvae can be extracted mechanically using a screw press. This results in a BSF press cake and BSF crude oil. The BSF press cake is a dry but rough material high in protein. The BSF crude oil is called “crude” because besides the fat it also contains solids, which mainly consist of proteins and fibres.

Materials and equipment needed:



Screw press
Model: Vevor DL-ZYJ10B
Capacity: 5 kg/h



Container for press cake
Plastic box: 55x35x 12 mm



Container for press liquid
5 L, stainless steel



Sieve
Mesh size: 0.5 mm,
Stainless steel



Allen key



Bulk balance
Max. capacity: 35 kg
Accuracy: ± 0.5 g

Tasks:

- Step 1:** Prepare the screw press for operation. Turn on the screw press and heat it up to 100°C and place the containers under the respective openings: the container for collecting the press cake under the big outlet of the press, the oil collecting container under the small crevice openings at the screw outlet. Place a sieve on top of the oil collection container. Start the screw turning by pressing the squeeze button.
- Step 2:** Weigh the dried larvae you are planning to press using a bulk balance. Add larvae to the hopper, little by little. Avoiding overloading the hopper prevents blocking of the screw press and therefore increases the throughput per hour.
- Step 3:** After all larvae have been added to the hopper, wait a few more minutes until no press cake and no liquid is exiting the machine and then stop the screw (pressing the stop button). Empty the remaining material from the press by reversing the screw turning direction (cleaning button).



Step 1: Setup of screw press.



Step 2: Adding little by little dried larvae to the hopper.



Step 3: Wait until no press cake is coming out anymore.

Step 4: Weigh the obtained press cake and weigh the press liquid and note it down on the log sheet. Proceed directly with the refining step or else store the press cake and press liquid (crude oil) temporarily in suitable closed containers. Label the containers with the production date.

Step 5: We recommend a cleaning step after each use of the screw press, as this ensures product quality and safety, avoiding remains of an older pressing contaminating a new batch. Regular cleaning after each batch also prolongs the life time of the equipment. For cleaning, wait until the machine has cooled down and then simply loosen and remove the screws in the tube using an Allen key, and clean all parts with water and detergent.



PROTECTIVE MEASURES FOR WORKERS:

- Use oven gloves, eye protection and protective clothing during oven drying activities.



POINTS OF MONITORING AND DATA COLLECTION:

- Measure the weight of the dried larvae per batch before pressing and measure the weight of press cake and BSF crude oil after pressing the whole batch. Note down the weights in the log sheet.



The **fractioning module from the e-learning video series** on BSF Biowaste Processing is available through this link.



5.2.5 Refining

Both products from fractioning, the BSF press cake and the BSF crude oil should be further refined. The BSF press cake needs a grinding step to reduce its particle size. As the BSF crude oil contains solids, it should be further refined by filtering or decanting to increase its purity.

Grinding

To ensure a fine and homogenous particle size of the BSFL protein meal, the dry press cake has to be grinded to a mesh size of 100 to 200 μm . Dry press cake has a rough texture, but if you intend to use extruders and pelletizers these require a fine input material. That is why the grinding step is an essential refining step to obtain a high quality raw material.

Materials and equipment needed:



Coffee grinder

Motor: 350W
Exhaust fan: 700W



Dust collecting fabrics



Container for press cake

Plastic box: 55x35x12mm



Storage container



Bulk balance

Max. capacity: 35kg
Accuracy: $\pm 0.5\text{g}$

Tasks:

Step 1: Prepare the grinder for operation. Place containers under the two outlets of the grinder: The main outlet and the exhaust outlet. Cover the two outlets with a fabric bag and start the grinder.



Step 1: Grinder setup.



Step 2: Adding of press cake to the grinder.



Step 3: BSF meal collection

Step 2 : Continuously add dry press cake to the hopper until all press cake has been grinded.

Step 3: Stop the grinder and remove the fabric bag from the grinder.

Step 4: Weigh the BSF meal and note it down on the log sheet. Store the meal in a closed container and label it with the production date.



PROTECTIVE MEASURES FOR WORKERS:

- Use gloves, eye protection and protective clothing during grinding activities.



POINTS OF MONITORING AND DATA COLLECTION:

- Measure the weight of BSF meal.

Oil refining

Solids can account for up to 40% of the total BSF crude oil mass. The solids consist mainly of fibres and protein and can be separated from the BSF oil by a filtration or decanting step. As BSF oil can be solid at room temperature, refining should be performed directly after pressing, when the crude oil is still warm. If the oil is solid then it is not possible to use filtration or decanting for separation. You would then need to heat the oil slightly so that it becomes liquid. The oil refining process is important when you want to include the BSF oil in other products like BSF pellets, or also BSF soap.

A) Oil filtering

Filtration recovers all solids whereby oil passes through a filter. A simple and passive setup using e.g. coffee filters can separate the solids from the oil. The filtration process can be supported by a vacuum pump, which can increase the filtration speed. Filtration is a slow process, which can take up to 15 hours per kg crude BSF oil. Therefore, filtration is only recommended for small batches. For larger batches the oil might become solid after a while, which then stops the filtration process.

Materials and equipment needed:



Coffee filter



Plastic funnel



Oil storage container
Light tight



Vacuum pump
Cast DOA-P504-BN



Filter paper
Pore size 120 µm



Erlenmeyer



Buchner funnel

Tasks:

Step 1: Prepare the filtration setup using a vacuum pump by placing the funnel on top of the Erlenmeyer and connect it via tube to the vacuum pump. Place a fresh filter paper on top of the funnel and turn on the vacuum pump.



Step 1: Vacuum pump setup.



Step 2: Pouring of BSF oil on top of the filter.

Step 2: Pour the crude BSF oil into the funnel and let the crude oil filter through.

Step 3: Stop the vacuum pump and collect the refined BSF oil. Discard the filter paper and the filtered solid residue. Note down the weight of the oil collected.

Step 4: Store the BSF oil in a light tight container and label it with the production date.

If you do not have a vacuum pump set up:

→

Adaptation step 1:

Use a coffee filter instead of filter paper. Place the funnel on top of any kind of container and let the fat passively filter through the coffee filter by gravity.

B) Oil decanting

If you have larger quantities of crude BSF oil, filtering is not feasible. If you do not have access to more sophisticated equipment like an oil decanter centrifuge, you can also use the simple method of decanting. With time the solids will settle as sediment at the bottom of the crude oil container. The BSF oil can then be separated from the solids by decanting. The oil is collected by inserting a tube into the oil fraction at the top of the container. After an initial suction with the aid of a syringe the oil automatically flows through the tube into the second collection container. This process is quicker compared to filtration. However, suspended solids that do not settle to the bottom will not be separated using this method, therefore resulting in a less pure product.



Adaptation step 1: Simple setup using a coffee filter and funnel.

Materials and equipment needed:



Plastic syringe



Plastic tube



Oil storage container
Light tight



Cylindrical container

Tasks:

- Step 1:** Oil preparation. Leave the crude oil for a few hours in a cylindrical container. If your crude oil gets hard, place the container in a warm water bath. The solids are heavier than the oil, therefore they will settle at the bottom of container and you can decant the oil on top. Make sure you handle the container with care in order to prevent settled solids from being suspended again.
- Step 2:** Setup preparation. Place the cylindrical container on top of an empty box or container, so it's on a higher level compared to the storage container. Attach the syringe to one end of the plastic tube. Insert the other end of the plastic tube into the upper oil fraction.



Step 3: Pulling the syringe to start the decanting process.

- Step 3:** Start decanting by pulling the syringe so the oil is sucked from the crude oil container. Remove the syringe and let the oil flow into the lower storage container by gravity. Make sure the tube is constantly immersed in the top oil fraction and does not suck up the solids at the bottom of the container.
- Step 4:** Stop the process as soon as the tube touches the solids at the bottom of the container.



PROTECTIVE MEASURES FOR WORKERS:

- Use gloves, eye protection and protective clothing during oil refining activities.



POINTS OF MONITORING AND DATA COLLECTION:

- Measure the weight of collected refined BSF oil. .



The **refining module from the e-learning video series** on BSF Biowaste Processing is available through this link.



5.3 Monitoring, Storage and Product Labelling

Monitoring

To keep track of your post-processing activities we recommend filling a log sheet on each production day. A template log sheet can be found in the Appendix H. The data recorded in the log sheet allows checking on process control parameters. The mass balance is an important process control parameter, as it gives an indication if the process is completed. A simple way to check the mass balance is to calculate the output yield by dividing output mass by input mass:

$$\text{Yield \%} = \frac{\text{Total mass OUT}}{\text{Total mass IN}} \times 100$$

With this percentage, you can control your drying or fractioning process, as the yield remains constant within a range. However, the waste source and harvesting time point will have an influence on the yields, as water and fat contents vary. Average values calculated at a pilot site are noted in the mass flow diagram in Figure 5–3.

Storage

Spoilage of BSFL products is influenced by various factors which include temperature, humidity, water activity, oxygen and light exposure. High temperature and humidity can lead to an increase in water activity and hence, to spoilage through microorganism activity. However, the initial con-

tamination with microorganisms in the BSFL product will depend on the waste source as well as cleaning and drying processes applied to the BSFL. Light and oxygen exposure can promote lipid oxidation, which results in off-flavours, colour and form changes.

Choosing the right storage container and packaging helps to avoid rapid spoilage of BSFL products. Storage containers should be air and light tight as well as water proof. Similarly, packaging material should be water proof and for high fat products like BSF oil or dried BSFL they should also be light tight. Adding pre-packed desiccants to packed products sustains a low humidity level inside the package and thereby keeps the water activity low. All products should be sealed before selling as a guarantee for the customer that the product was not opened before. All products should be stored in a place protected from high temperatures, weather and direct sun light.

Labelling

Your final packed BSF product requires a label, which holds relevant product information, is able to ensure traceability and invites customers to buy your product. Figure 5–4 shows an example of a product label designed for the microwave dried BSFL, called pop-larvae.



Figure 5–4: Example label for microwave dried BSFL, called pop-larvae

The different information shown in the example label above are listed and explained in Table 5–3.

Table 5–3: Items to add to a product label

#	Labelling info	Description
1	Nutritional content	Include at least protein, fat and water content.
2	Production date	Important for traceability of your products
2	Expiry date	This is important usage information and helps to avoid complaints.
3	Product description	e.g dried BSF larvae or BSF meal, your brand name (pop-larvae) may be unclear
4	Netto weight	Amount of product per pack
5	Pictures of target animals	To visually indicate the intended use of the product.
6	General information / benefits	This can help to catch interest of customers.
7	Usage instructions	Indicate how to feed the animals with the product.
8	Storage instructions	Mention where and how to store the product.
9	Company / brand name and address	Information where customers can find you. This could be a website, social media or a location.



**PUSAT PENGOLAHAN MATERIAL ORGANIK
DAN BUDIDAYA BLACK SOLDIER FLY**

**INTEGRATED
TECHNOLOGY**

**KAWASAN
PENELITIAN**

TAMU WAJIB LAPOR
KE KANTOR

VISITORS MUST REPORT
AT OFFICE

Chapter 6:

Business development

A business model for your BSF facility should be in place before starting your venture especially if the intention is to run it as a business. This chapter provides some tools to support your business model with numbers and to help identify what preconditions must be met before opening a BSF facility.

6.1 Cost-revenue analysis and financial viability

Understanding and assessing the cost of BSF waste processing is an important aspect before starting or while operating a BSF facility. This involves not only estimating the capital costs required for construction but also appraising the expected operational costs for a specific local context and monitoring cost units during operations. Here we present two tools to help with cost-revenue assessments and allow judgement on the financial viability of a BSF biowaste processing facility.

The “scenario based business model tool” is for those that want to look at a BSF facility in detail. It dissects each processing unit individually in terms of capital and operational cost. It provides material lists required but also allows for individual adjustments if the user has experience and is familiar with the specific local conditions at the location of interest. Analysis of each processing unit separately allows to appraise different business models, for instance different degrees of decentralization and management of supply chains. After choosing a desired scenario, and entering other input variables, the tool then calculates key financial parameters such as Net Present Value (NPV), to determine the value of such a potential investment project.

Another tool is the “web-based cost model tool”, that provides a much more simple overview of the costs involved in developing a BSF facility, based on the amount and type of waste conceived. The tool utilizes data from the existing site and design in Indonesia, and provides default processing conversions values, to calculate costs of capital expenditure and cost of production per unit. The user then can assess the local market and potential sales prices of BSF products to judge if a profit margin is possible.

Assessing potential revenue flows derived from BSF waste processing and comparing these to cost items of a BSF facility, depending on scale of operation, gives a good indication if financial viability might be achieved. Although experience and data from existing facilities can give a good indication of space, equipment and labour requirements there are nevertheless variables that will affect this data which depend very much on the local specific context and conditions:

- CAPEX or capital costs of the facility (e.g. local cost for constructing custom-made materials, local availability of equipment, etc.)
- OPEX or operational cost of the facility (e.g. local utilities cost, local labour wages, etc.)
- Climate and other environmental impacts (e.g. temperature, humidity, odour prevention, waste water management, etc.)
- Potential revenues from waste processing (gate fees)
- Potential sales revenue from larvae derived products (e.g. whole larvae, dried BSFL, BSF meal and BSF oil)
- Sales revenue from BSF rearing products such as 5-DOL sold for the use of converting waste at other locations
- Sales of the waste residue as soil amendment or sales of related products such as biogas from treating residue.

6.2 The scenario-based business model tool

The scenario-based business model tool was developed to differentiate each processing unit of the facility based on “Activity Based Costing”. This allows the user to compare different scenarios of business models and implementation. Three distinct scenarios are made available in the tool which are described by the following figures below:

- **Scenario 1:** This scenario assumes one full-fledged centralised plant which includes all processing units at one location. This central BSF facility, receives organic waste, processes this waste with BSF to obtain grown larvae and then converts (post-processing) these larvae into BSFL products such as fresh larvae, dried larvae and/or larvae meal and oil. This same facility also runs a rearing unit that closes the lifecycle to ensure pupae, flies and eggs and continuously provides 5-DOL for the treatment unit (Figure 6–1).

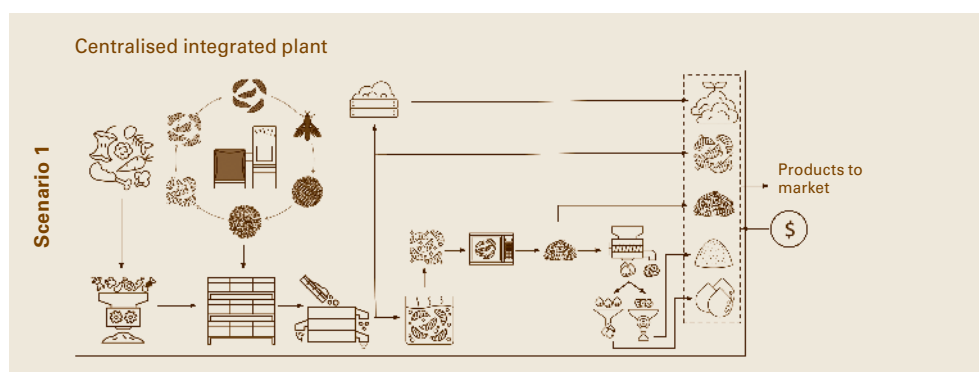

Figure 6–1: Scenario 1: Centralised integrated plant

- **Scenario 2:** This scenario consists of two separate business units not located at the same premises. First, a centralised rearing facility that focuses exclusively on closing the life cycle to continuously produce 5-DOL for use at different treatment facilities. Then, individual treatment facilities located at different locations throughout the city, ideally close to the source of waste generation. These decentralised treatment facilities process organic waste using the 5-DOL from the rearing facility to obtain grown larvae and also convert these grown larvae into BSFL products such as fresh larvae, dried larvae and/or larvae meal and oil (Figure 6–2)

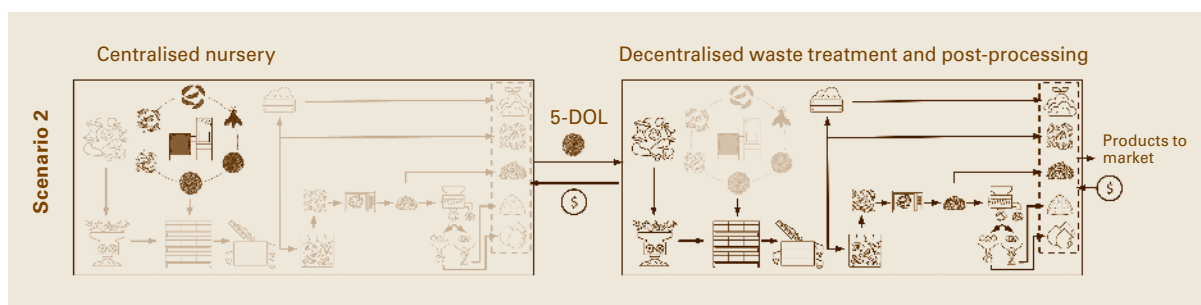

Figure 6–2: Scenario 2: Centralised nursery, decentralised treatment and post-processing

- **Scenario 3:** This scenario is similar to scenario 2 with decentralised treatment facilities. In this case however the treatment facilities also obtain 5-DOL to conduct waste treatment but then do not process the grown larvae into products but instead sell the fresh grown larvae back to the central facility. This central facility therefore does not only rear 5-DOL for the treatment facilities but also receives grown larvae from them to convert these larvae into BSFL products such as fresh larvae, dried larvae and/or larvae meal and oil (Figure 6–3).

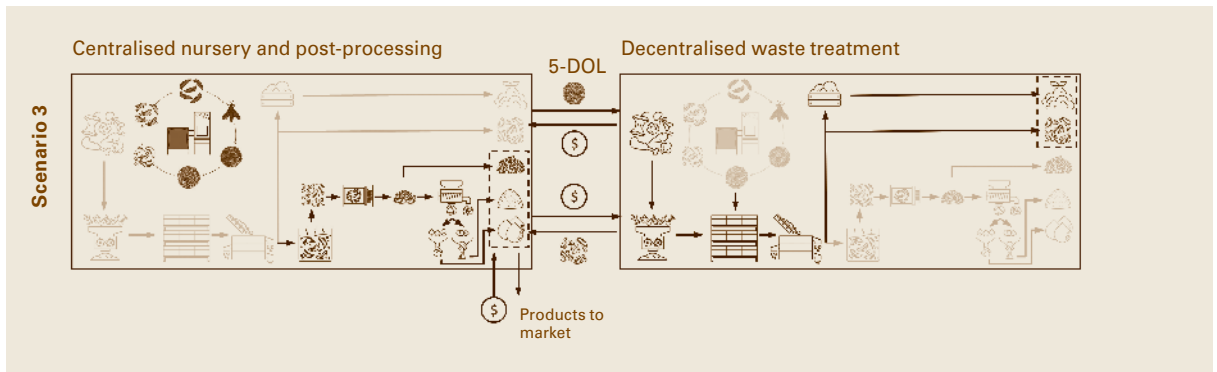

Figure 6–3: Scenario 3: Centralised nursery and post-processing, decentralised treatment

As described in the scenarios 2 and 3, these models require a supply chain and an exchange of crucial goods between the centralised and decentralised facilities. For both scenarios 2 and 3 the regular supply of 5-DOL is vital. This is a source of income for the rearing facility and is a raw material for the treatment facility besides the waste they receive. For scenarios 3, the exchange of goods goes in both directions. 5-DOL are transferred from the rearing/post-processing facility to the treatment facility and then grown larvae are transferred back from the treatment facility back to the rearing/post-processing facility. In this exchange, it is important to find a pricing scheme for these products that is beneficial for all parties. If the rearing facility charges too high prices for their 5-DOL, then the decentralised treatment facility might run into a deficit and go out of business. Similarly, if the decentralised treatment facility charges a too high price for the grown larvae, then nursery/post-processing facility may go out of business.

The scenario-based business model tool helps identify pricing schemes for such product exchanges while also considering the scale of operation of each facility given the impact of economies of scale.

Furthermore, the tool gives insights into the cost structure of each processing unit and provides financial performance indicators as well as key capital budgeting indicators such as net present value (NPV), payback period (PB) and internal rate of return (IRR) based on a period of 5 years with a discount rate of 11%.



The scenario-based business model tool is an excel based tool. Each scenario has its own excel file where the user can fill in the required data. All the excel models as well as a manual can be downloaded for free through this link.



6.3 The web-based cost model tool

The web-based cost model is a more simplified version of the “scenario-based business model tool”. It assumes a central plant with all units integrated in one facility. It estimates operational cost to provide the user with the production cost per unit of BSF product (i.e. costs incurred from manufacturing a BSF product). This can then be compared with current sales prices of similar competing products on the market. The user selects a scale of operation based on the amount of waste that shall be treated, what BSF products shall be sold, and enters some additional unit costs given the local context (labour costs, utility costs, etc.). Default conversion values based on the experience from Indonesia are provided, but these can be individually adjusted by the user if other information is available. The benefit of using this web-based cost model tool is that you do not need to be a BSF expert. It is enough to be a BSF enthusiast that wants to explore what it means to operate a BSF facility, how much product and what production cost you might expect. The tool output is shown as a flowchart including mass flows through the different processing units besides the costs.



The web-based cost model is an online tool which focusses on calculating the operational cost per unit of a selected BSF product.

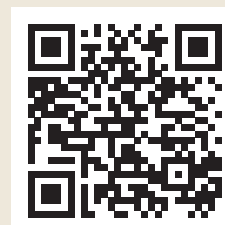

6.4 Siting a BSF waste processing facility

Understanding the natural life-cycle is the basis for setting up an efficient and reliable BSF waste processing facility. At the facility, with its infrastructure, equipment and workers with their skill sets, the operator takes control over the natural life cycle of BSF to thus, create and operate an engineered biosystem.

The facility location with its components and activities strives to best mimic the natural habitat and the needs of the BSF, while steering them towards increased efficiency and stability so that a continuous waste treatment can be ensured. The following aspects should be taken into consideration when selecting an appropriate site for a BSF processing facility:

- Nearby sources of good quality biowaste in regular and/or predictable amounts. The closer the facility is to the waste, the lesser is the need for transport and logistics of waste sourcing.
- Nearby customers for larvae and their conversion products. The closer the distance to your customers the easier it is to maintain suitable market channels and enhance customer relationships while also reducing transport costs.
- Appropriate location in the city or neighbourhood that does not incur conflicts with or obstruction by residents or adjacent land users.
- Adequate green zones that can buffer the facility from the surrounding area (e.g. open areas, trees, fences, etc.)
- Availability of water, a wastewater system and connection to a power grid
- Adequate building infrastructure and quality. The treatment area should have a roof and a concrete base to provide shelter and provide a clean workspace. An office, toilet facilities and lab space should also be available.

When the location has been selected and construction plans are being developed the following specific aspects need to be considered:

- The site should be protected from infestation of pests and vermin. Ant traps are required for contact points between the equipment and the floor. Ensure that there is no contact between equipment and the walls. Mesh wire protection may be required for all essential components of the rearing operation to avoid birds, rats and lizards from accessing the larvae.
- Treatment units need to be placed away from direct sunlight, maintained at temperatures of around 25 degrees and without impact of rain and ideally kept at low humidity.
- Rearing stages of egg, pre-pupae and pupae need high humidity and temperatures of around 28 degrees with full shading from the sun.
- Rearing stage of the larvae need to be kept at a low humidity, temperatures of around 25 degrees and with full shading from the sun.
- Rearing of the fly and mating stages need high humidity a temperature of around 28 degrees and abundance of indirect sunlight.
- Post-processing unit needs to have sufficient ventilation, comfortable temperature for manual labour and very low humidity levels.

6.5 Creating a floorplan and planning the unit locations for a BSF site

One of the outputs of both cost model tools, as described above, is the space requirements for each of the three units (rearing, conversion/treatment and post-processing) at a BSF facility depending of the scale of waste input. Figure 6–4 shows an example of a floorplan for the selected facility of 5 tons of biowaste per day.

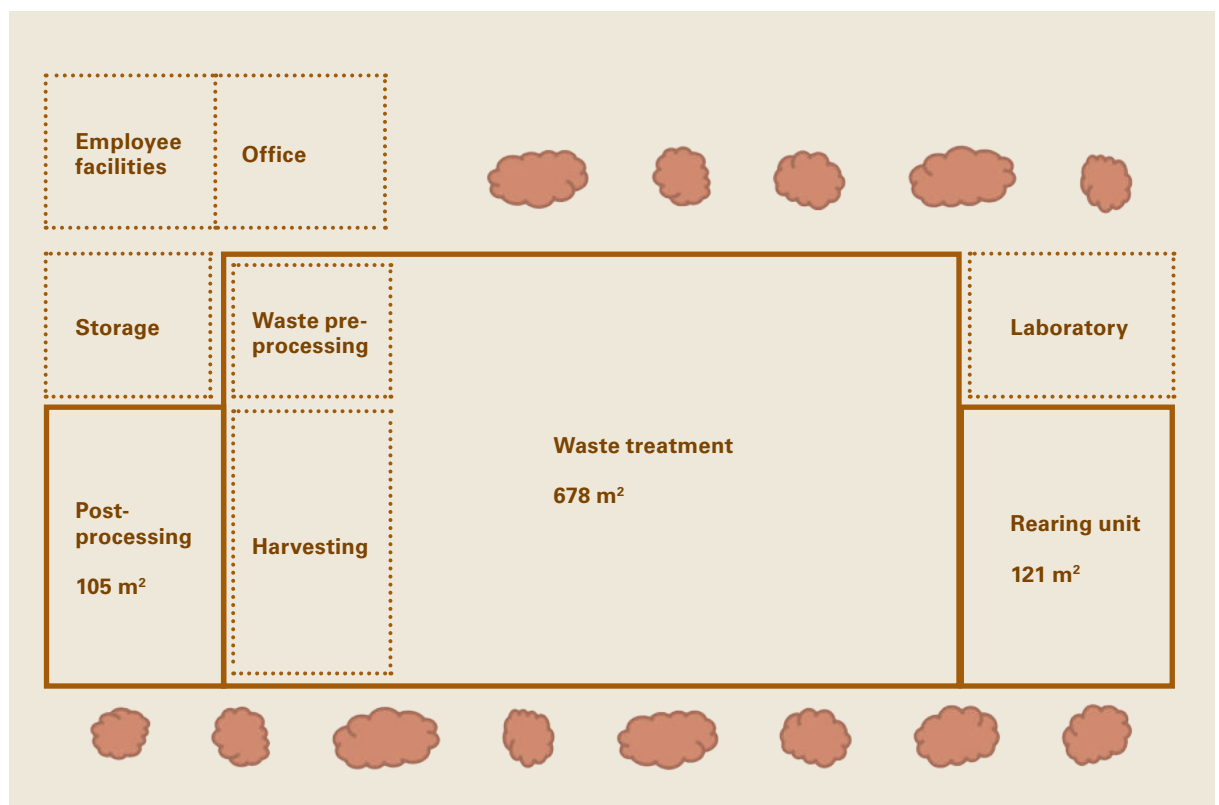

Figure 6–4: Floorplan for BSF biowaste processing plant with a capacity of 5 tons biowaste input per day

When comparing different scales (see Table 6–1) and the respective space requirements at these scales, it becomes clear that this does not increase or decrease linearly with the increase or decrease in waste input. Especially the rearing unit shows the least dependency between scale and space requirement. Here the equipment, for instance the racks, come with a fixed

scale of design. In that sense smaller scale does not affect space requirements but indicates that the equipment is not used at full capacity. In contrast, the waste treatment unit shows a strong dependency between scale and space. This is the result of a small unit size of equipment. For every small change of scale the total number of these small pieces of equipment increases immediately requiring more space to accommodate. Lastly, the post-processing unit, show a similar pattern as the rearing unit. The capacity of most installed equipment is often not the limiting factor and therefore a decrease or even increase of scale can be accommodated with the same piece of equipment. This is shown in Table 6–1 when comparing scale of 1 ton and 2 tons of waste processed per day. Although the scale has doubled there is almost no effect on the floorspace required.

Table 6–1: Overview of site scale and effect on size of the different operational units

Amount of waste processed per day	Area Rearing	Area Conversion	Area Processing	Total Area
5 ton/d	121 m ²	678 m ²	105 m ²	±900 m ²
2 ton/d	71 m ²	286 m ²	47 m ²	±400 m ²
1 ton/d	47 m ²	160 m ²	44 m ²	±250 m ²

6.6 Operational scenarios and work scheduling

The operational guidance as provided in this book is based on a BSF treatment facility that has the capacity to produce enough 5-DOL to treat around 35 tons of biowaste per week. This requires a daily presence and work schedule, seven days a week.

Depending on waste, space and labour availability, one could however also choose a reduced work schedule that can be managed working only half of the days in a week or even less with an alternate Monday-Wednesday-Friday work schedule (see Table 6–3).

Table 6–2: Capacity of the described BSF facility depending on work schedule

Work schedule	Waste capacity	Output of 5-DOL	workers required	Area	Daily 5-DOL output fluctuation
1 Every day	35 ton/wk	±50 million/wk	23	900 m ²	Stable
2 Every other day	14 ton/wk	±20 million/wk	12	400 m ²	Small fluctuation
3 Mon-Wed-Fri	7 ton/wk	±8 million/wk	9	250 m ²	Large fluctuation

The work schedules and log sheets presented in the annexes are developed for an every day work schedule. This setup has shown to be the most stable in the production of young larvae and is the most reliable for converting a daily continuous flow of biowaste arriving at the site. For all three work schedules, different task lists and feeding schedules have been designed and are available for download.



Besides the “every day” work schedule as provided in the Annex, this link provides access to two different operational scenarios with respective work schedules. The manual explains the impact of these different work scenarios and how to prepare these schedules.



The work schedules use a date code format: **XX.Y**. This allows for easy date calculations and tagging of cages and containers. The **XX**-value indicates the calendar week of the year (week 01-52/53). The **Y**-value indicates the day of the week (Monday-Sunday = 1-7).

Date:

Tuesday, February 21

Code:

8.2

**Week 8 of the year
Day 2 of the week**

Work schedules are only available for the rearing (Annex A) and conversion (Annex C) units, as the post-processing unit uses “Standard Operating Procedures” (SOP) files related to the operational steps at each operational station. In the work schedules, a short explanation is provided for each task and the columns to the right are left white when the task has to be performed on that day or shaded black when this task does not need to be performed. Work schedules should be placed clearly visible and accessible somewhere close to where the staff is working so that the personnel following the checklist can check off each task when completed. Each work schedule covers a period of four weeks which is then replaced with new schedules by the facility manager for the next period.

The rearing unit requires one additional schedule for the feeding of the nursery larveros (Annex B). In the nursery larveros, 5-DOL are fed about 2-3 weeks until they transform into pre-pupae. The pre-pupae are then put into pupation containers to eventually become flies. Nursery larveros are fed a nutrient rich feed. The harvesting of pre-pupae relies on crawl-off. Towards the end of the feeding phase, the water content of the feed is increased, which allows pre-pupae to increase traction to then be able to crawl out of the nursery container. The feeding schedule for the nursery container informs the operator which feed mixture has to be applied to which nursery container.

Date	Set-up	1 KG	2 KG	2 KG	2 KG	2 KG	2 KG	2 KG	1 KG	1 KG	Dism.
8.1	8.1	7.6	7.5	7.3	7.2	6.7	6.6	6.5	6.3	6.1	5.5
8.2	8.2	7.7	7.6	7.4	7.3	7.1	6.7	6.6	6.4	6.2	5.6
8.3	8.3	8.1	7.7	7.5	7.4	7.2	7.1	6.7	6.5	6.3	5.7

Today's code

Indicate the IDs of the nursery containers to be fed today

Number and colour indicate the amount and type of feed to be fed

ID of the nursery container to be dismantled today

The left white column indicates the current date. The second column indicates the date code for the nursery larvero that will be set-up on that day. The other cells along the row indicate the ID of the nursery larveros to be fed at the date as shown in column 1. The colour indicates the amount and type of feed they receive. The feed differs in terms of the amount of water added to the chicken feed (CF) and ranges from 70 - 100% water.

1kg / 30% CF / 70% H ₂ O	2kg / 30% CF / 70% H ₂ O	2kg / 15% CF / 85% H ₂ O	1kg / 100% H ₂ O
-------------------------------------	-------------------------------------	-------------------------------------	-----------------------------

The table presented in the Annex is meant to serve as a template for an Excel-sheet; an operator can easily update a schedule in Excel according to formulas.

Annexes D, E, F, and G present the respected log sheets which were prepared as a template for a recording file to enter all the data that will be collected on each day of operation. All the monitoring data to assess productivity of the unit can be entered on this sheet.



Annexes

Overview of available schedules and log sheet templates.

Annex

A

Work schedule for rearing unit in the every day-full capacity setting



Annex

B

Feeding schedule nursery larvero for every day-full capacity setting



Annex

C

Work schedule for conversion unit in the every day-full capacity setting



Annex

D

Log sheet for daily data input of productivity parameters in **BSF rearing unit**



Annex

E

Log sheet for daily data input of productivity parameters in treatment step of **BSFL conversion unit**



Annex

F

Log sheet for daily data input of productivity parameters in **pre-processing and harvesting** stage BSFL conversion unit



Annex

G

Log sheet for daily data input of productivity parameters in **BSFL post-processing unit**



Annex A:

Work schedule for nursery in the every day setting. "xx" marks the calendar week and the numbers below indicate the day of the week (e.g. 1 is Monday, 2 is Tuesday, etc.). Mx refers to measuring/monitoring tasks below

#	Day	xx							xx							Time min		
		1	2	3	4	5	6	7	1	2	3	4	5	6	7			
Nursery tasks																		
1	Remove (5d) old nursery box (3 boxes/day) (M1)																<ul style="list-style-type: none"> Take out 3 boxes of 5-DOL Weigh the total mass (g) 	10
2	Connect new love cage to dark cages																<ul style="list-style-type: none"> Weigh empty & clean cage and bamboo frame Connect love cage to first dark cage Disconnect love cage after 30mins Weigh cage (filled with flies) again Connect to next dark cage and repeat process 	30
3	Prepare (16) new pupation boxes																<ul style="list-style-type: none"> ¾ compost, ¼ H2O 3 kg of mixture per box Place boxes in pupation frame 	30
4	Remove old nursery Larvero																<ul style="list-style-type: none"> Remove material Use material for fly attractant 	10
5	Harvest and process prepupae (PP) (M2)																<ul style="list-style-type: none"> Sieve PP from outer box Add coco peat to outer box and place back Weigh PP from each Larvero 	60
6	Add food in nursery Larveros																<ul style="list-style-type: none"> (see Appendix B for the feeding schedule) 	10
7	Hatchling shower maintenance																<ul style="list-style-type: none"> Remove and clean (5d) old tea strainers Add water (0.5L) to oldest nursery boxes Add coco peat (1-2 d before counting) 	20
8	Prepare nursery box (3 boxes/day)																<ul style="list-style-type: none"> Add 3kg of feed/crate and cover with coco peat Place under tea strainers 	10

Week	XX							XX							XX							Time min	
	1	2	3	4	5	6	7	1	2	3	4	5	6	7	1	2	3	4	5	6	7		
# Day	1	2	3	4	5	6	7	1	2	3	4	5	6	7	1	2	3	4	5	6	7		
Nursery tasks																							
9 Prepare new nursery Larvero (2 boxes/day)																							10
	<ul style="list-style-type: none"> · Add 2 kg of feed to the box · Cover with coco peat · Add 10,000 5-DOL/box · Place the box on outer box · Add coco peat to outer box 																						
10 Remove (4 d) old love cage (2 cages/day) (M3)																							60
	<ul style="list-style-type: none"> · Remove eggies from cage · Collect dead flies for new attractant · Clean containers removed from LC · Wash cage on Cotton quick programme 																						
11 Set-up new love cage (2 cages/day) (M4)																							40
	<ul style="list-style-type: none"> · Weigh full cage with flies · Move cage to love cage table · Add attractant, eggies, cover & water container · Take sample of 20 flies (1x) 																						
12 Remove (3 wk) old dark cages																							10
	<ul style="list-style-type: none"> · Take (16) boxes out · Empty boxes · Wash cage on Cotton quick programme 																						
13 Set-up new dark cages																							10
	<ul style="list-style-type: none"> · Add 16 pupation boxes/cage · Add label on it and tie the cage tunnel 																						
Upkeep tasks																							
U1 Fill water of ant traps																							5
U2 Clean nursery room																							240
	<ul style="list-style-type: none"> · Sweep floor and clean frames 																						
U3 Clean work tables																							5
	<ul style="list-style-type: none"> · 1st with detergent, 2nd with alcohol 																						

B

Feeding schedule for the nursery larveros in the every day setting. “xx” marks the calendar week. The “+1” indicates the following week, the “-1” indicated the previous week and “-2” the week before that, etc. The colours are related to an amount of feed in a certain ratio of chicken feed (CF) to water.

Annex B:

Date	Set-up	2 KG	2 KG	2 KG	2 KG	2 KG	2 KG	1 KG	1 KG	Dism.
xx.1	xx.1	xx-1.5	xx-1.3	xx-1.2	xx-2.7	xx-2.6	xx-2.5	xx-2.3	xx-2.1	xx-3.5
xx.2	xx.2	xx-1.6	xx-1.4	xx-1.3	xx-1.1	xx-2.7	xx-2.6	xx-2.4	xx-2.2	xx-3.6
xx.3	xx.3	xx-1.7	xx-1.5	xx-1.4	xx-1.2	xx-1.1	xx-2.7	xx-2.5	xx-2.3	xx-3.7
xx.4	xx.4	xx.1	xx-1.6	xx-1.5	xx-1.3	xx-1.2	xx-1.1	xx-2.6	xx-2.4	xx-2.1
xx.5	xx.5	xx.2	xx-1.7	xx-1.6	xx-1.4	xx-1.3	xx-1.2	xx-2.7	xx-2.5	xx-2.2
xx.6	xx.6	xx.3	xx-1.8	xx-1.7	xx-1.5	xx-1.4	xx-1.3	xx-2.8	xx-2.6	xx-2.3
xx.7	xx.7	xx.4	xx-1.9	xx-1.8	xx-1.6	xx-1.5	xx-1.4	xx-2.9	xx-2.7	xx-2.4
xx+1.1	xx+1.1	xx.5	xx-2.0	xx-1.9	xx-1.7	xx-1.6	xx-1.5	xx-3.0	xx-2.8	xx-2.5
xx+1.2	xx+1.2	xx.6	xx-2.1	xx-2.0	xx-1.8	xx-1.7	xx-1.6	xx-3.1	xx-2.9	xx-2.6
etc.	etc.	etc.	etc.	etc.	etc.	etc.	etc.	etc.	etc.	etc.
etc.	etc.	etc.	etc.	etc.	etc.	etc.	etc.	etc.	etc.	etc.

Date	Set-up	2 KG	2 KG	2 KG	2 KG	2 KG	2 KG	1 KG	1 KG	Dism.
6.1	6.1	5.5	5.3	5.2	4.7	4.6	4.5	4.3	4.1	3.5
6.2	6.2	5.6	5.4	5.3	5.1	4.7	4.6	4.4	4.2	3.6
6.3	6.3	5.7	5.5	5.4	5.2	5.1	4.7	4.5	4.3	3.7
6.4	6.4	6.1	5.6	5.5	5.3	5.2	5.1	4.6	4.4	4.1
6.5	6.5	6.2	5.7	5.6	5.4	5.3	5.2	4.7	4.5	4.2
6.6	6.6	6.3	6.1	5.7	5.5	5.4	5.3	5.1	4.6	4.3
6.7	6.7	6.4	6.2	6.1	5.6	5.5	5.4	5.2	4.7	4.4
7.1	7.1	6.5	6.3	6.2	5.7	5.6	5.5	5.3	5.1	4.5
7.2	7.2	6.6	6.4	6.3	6.1	5.7	5.6	5.4	5.2	4.6
7.3	7.3	6.7	6.5	6.4	6.2	6.1	5.7	5.5	5.3	4.7
7.4	7.4	7.1	6.6	6.5	6.3	6.2	6.1	5.6	5.4	5.1
7.5	7.5	7.2	6.7	6.6	6.4	6.3	6.2	5.7	5.5	5.2
7.6	7.6	7.3	7.1	6.7	6.5	6.4	6.3	6.1	5.6	5.3
7.7	7.7	7.4	7.2	7.1	6.6	6.5	6.4	6.2	5.7	5.4
8.1	8.1	7.5	7.3	7.2	6.7	6.6	6.5	6.3	5.8	5.5
8.2	8.2	7.6	7.4	7.3	7.1	6.7	6.6	6.4	5.9	5.6
8.3	8.3	7.7	7.5	7.4	7.2	7.1	6.7	6.5	6.0	5.7
8.4	8.4	8.1	7.6	7.5	7.3	7.2	7.1	6.7	6.2	5.8
8.5	8.5	8.2	7.7	7.6	7.4	7.3	7.2	6.7	6.3	6.2
8.6	8.6	8.3	8.1	7.7	7.5	7.4	7.3	7.1	6.6	6.3
8.7	8.7	8.4	8.2	8.1	7.6	7.5	7.4	7.2	6.7	6.4
9.1	9.1	8.5	8.3	8.2	7.7	7.6	7.5	7.3	7.1	6.5
9.2	9.2	8.6	8.4	8.3	8.1	7.7	7.6	7.4	7.2	6.6
9.3	9.3	8.7	8.5	8.4	8.2	8.1	7.7	7.5	7.3	6.7
9.4	9.4	9.1	8.6	8.5	8.3	8.2	8.1	7.6	7.4	7.1
9.5	9.5	9.2	8.7	8.6	8.4	8.3	8.2	7.7	7.5	7.2
9.6	9.6	9.3	9.1	8.7	8.5	8.4	8.3	8.1	7.6	7.3
9.7	9.7	9.4	9.2	9.1	8.6	8.5	8.4	8.2	7.7	7.4

This is how the feeding schedule for the nursery larveros is built up: **Every day**, you set up a new nursery larvero and feed the nursery larvero whose date codes can be found in the same row with the corresponding amount and type of feed

This is how the sheet will be hanging on the wall of your colony. This example starts on Monday of week 6

30% CF	30% CF	15% CF	0% CF
--------	--------	--------	-------

Week		XX							XX							XX							Time min
#	Day	1	2	3	4	5	6	7	1	2	3	4	5	6	7	1	2	3	4	5	6	7	
Measuring/Monitoring tasks																							
M1	Waste sorting · Measure and note down weight of waste received from different waste sources																						10
M2	Pallet harvesting · Measure and note down weight of each crate of one pallet by placing stacks of 3 on the scale																						10
M3	Manual residue separation · Measure and note down weight of larvae after manually removing residue																						10
M4	Residue processing · Measure and note down weight of fine residue after bagging																						10
M5	Waste shredding · Measure and note down weight of waste after shredding																						10
M6	Compost maintenance · Measure and note down weight of different residue streams before piling them																						10
Total																						640	

D

Annex D:

log sheet for daily data input of productivity parameters in BSF rearing unit

Name responsible		Date code	
------------------	--	-----------	--

Egg Data

Date code of today

Date code of love cage managed

Weight of egg mass from the specific love cage

Data love cage	Mass harvested eggs (g)	Comments
12.2	67.3	
	73.5	
11.5	-	

5-DOL Data

Date nursery box	# 5-DOL in 2 grams	Average (#)	Mass 5-DOL (g)	# of 5-DOL
11.4	971	953	962	1,558
				750,000

Total mass x Average / 2

Prepupal Data

Keeps track of the number of prepupae harvested from the nursery containers

Weight of random sample of 200 prepupae taken from today's pooled nursery container harvest

Date nursery larvero	Mass pre-pupae (g)	Date nursery larvero	Mass pre-pupae (g)
10.6	113		
	145		
	67		
9.7	105		
Mass 100 PP (samples from all PP) 2x	1: 26.3g	2: 25.5g	Average: 25.9g

Prepupae in pupation box

Future date code of the dark cage that will be set up with these pupation containers

Cumulated prepupae per pupation container. See yesterday's log sheet for previous number

Date of dark cage for pupation container	# of boxes	PP added per box today (g)	Total PP (g)
12.4	16	500	1500

Love cage filling

IDs of dark cages to which the love cage is connected to

Weight of empty love cage (including hanger)

Cumulated weight love cage after every connection to a dark cage (including hanger)

Setting	Empty	1 st setting	2 nd setting	3 rd setting	4 th setting	5 th setting	mass 20 flies
ID of dark cage		9.3	10.3	11.3			1.68g
Mass of love cage	914	921	1,144	1,634			

D

Annex D:

Master copy of log sheet for BSF rearing unit

Name responsible		Date code	
------------------	--	-----------	--

Egg Data

Data love cage	Mass harvested eggs (g)	Comments

5-DOL Data

Date nursery box	# 5-DOL in 2 grams	Average (#)	Mass 5-DOL (g)	# of 5-DOL

Prepupal Data

Date nursery larvero	Mass pre-pupae (g)	Date nursery larvero	Mass pre-pupae (g)
Mass 100 PP (sample from all PP) 2x	1:	2:	Average:

Prepupae in pupation box

Date of dark cage for pupation container	# of boxes	PP added per box today (g)	Total PP (g)

Love cage filling

Setting	Empty	1 st setting	2 nd setting	3 rd setting	4 th setting	5 th setting	mass 20 flies
ID of dark cage							
Mass of love cage							

Comments

--

Name responsible		Date code	
------------------	--	-----------	--

Waste sorting and pre-processing

Waste source	Received (kg)	Types of substrate and waste fractions	To processing (kg)
<p>Note down origin of different biowaste streams arriving at the site</p>		Type:	<p>Note down the different types of substrates going into the BSF treatment (e.g. fruits, restaurant waste, bakery products, ...)</p>
		Type:	
		Type:	
		Type:	
		Composting	
		Inorganics Recycling	

Pallet harvesting

Pallet code:		Pallet code:		Pallet code:	
	Weight (kg)		Weight (kg)		Weight (kg)
Crate 1+2+3		Crate 1+2+3		Crate 1+2+3	
Crate 4+5+6		Crate 4+5+6		Crate 4+5+6	
Crate 7+8+9		Crate 7+8+9		Crate 7+8+9	
Crate 10+11+12		Crate 10+11+12		Crate 10+11+12	
Crate 13+14+15		Crate 13+14+15		Crate 13+14+15	
Crate 16+17+18		Crate 16+17+18		Crate 16+17+18	
Crate 19+20+21		Crate 19+20+21		Crate 19+20+21	
Crate 22+23+24		Crate 22+23+24		Crate 22+23+24	
Crate 25+26+27		Crate 25+26+27		Crate 25+26+27	
Crate 28+29+30		Crate 28+29+30		Crate 28+29+30	
Crate 31+32+33		Crate 31+32+33		Crate 31+32+33	
Crate 34+35+36		Crate 34+35+36		Crate 34+35+36	
Total weight (kg)		Total weight (kg)		Total weight (kg)	
Larvae		Larvae		Larvae	
Manually separated residue		Manually separated residue		Manually separated residue	
Residue (calculated)		Residue (calculated)		Residue (calculated)	

Results after subtraction of larval weight and manually sorted material from total weight

Weight of all larvae from the pallet after mechanical separation

Weight of manually separated residue

Sampling for substrate in, residue out and larvae

Pallet code:	DATE + Pallet CODE:		DATE + Pallet CODE:	DATE + Pallet CODE:			
Type	50g Substrate	50g Residue	50g Residue	20 BSFL	50g Substrate	50g Residue	20 BSFL
Tray 1							
Wet+T1							
Dry+T1							
Tray 2							
Wet+T2							
Dry+T2							
Tray 3							
Wet+T3							
Dry+T3							

Fill in pallet code based on schedule from Annex E

Fill in exact mass of samples with ±50g of substrate, ±50g of residue and 20 counted BSFL

Fill in weight of empty tray, then tray + wet material and then after drying the tray + dry material

F

Annex F:

Master copy of log sheet for pre-processing and harvesting stage of BSFL conversion unit

Name responsible		Date code	
------------------	--	-----------	--

Waste sorting and pre-processing

Waste source	Received (kg)	Types of substrate and waste fractions	To processing (kg)
		Type:	
		Type:	
		Type:	
		Type:	
		Type:	
		Composting	
		Inorganics Recycling	

Pallet harvesting

Pallet code:		Pallet code:		Pallet code:	
	Weight (kg)		Weight (kg)		Weight (kg)
Crate 1 + 2 + 3		Crate 1 + 2 + 3		Crate 1 + 2 + 3	
Crate 4 + 5 + 6		Crate 4 + 5 + 6		Crate 4 + 5 + 6	
Crate 7 + 8 + 9		Crate 7 + 8 + 9		Crate 7 + 8 + 9	
Crate 10 + 11 + 12		Crate 10 + 11 + 12		Crate 10 + 11 + 12	
Crate 13 + 14 + 15		Crate 13 + 14 + 15		Crate 13 + 14 + 15	
Crate 16 + 17 + 18		Crate 16 + 17 + 18		Crate 16 + 17 + 18	
Crate 19 + 20 + 21		Crate 19 + 20 + 21		Crate 19 + 20 + 21	
Crate 22 + 23 + 24		Crate 22 + 23 + 24		Crate 22 + 23 + 24	
Crate 25 + 26 + 27		Crate 25 + 26 + 27		Crate 25 + 26 + 27	
Crate 28 + 29 + 30		Crate 28 + 29 + 30		Crate 28 + 29 + 30	
Crate 31 + 32 + 33		Crate 31 + 32 + 33		Crate 31 + 32 + 33	
Crate 34 + 35 + 36		Crate 34 + 35 + 36		Crate 34 + 35 + 36	
Total weight (kg)		Total weight (kg)		Total weight (kg)	
Larvae		Larvae		Larvae	
Manually separated residue		Manually separated residue		Manually separated residue	
Residue (calculated)		Residue (calculated)		Residue (calculated)	

Sampling for substrate in, residue out and larvae

Pallet code:	DATE + Pallet CODE:			DATE + Pallet CODE:			DATE + Pallet CODE:		
	50g Substrate	50g Residue	20 BSFL	50g Substrate	50g Residue	20 BSFL	50g Substrate	50g Residue	20 BSFL
Tray 1									
Wet+T1									
Dry+T1									
Tray 2									
Wet+T2									
Dry+T2									
Tray 3									
Wet+T3									
Dry+T3									

G

Annex G:

log sheet for daily data input of parameters in BSFL post-processing unit

Name responsible		Date code	
	Today's operator		Date code of today

Drying method

Drying equipment used	Drum dryer (roasting)
-----------------------	-----------------------

Drying data

Mass IN (kg)	Mass OUT (kg)	Drying time (minutes)	Comments
5	1.5	35	
5	1.5	35	
5	1.5	35	
5	1.5	35	
Total IN (kg)	TOTAL OUT (kg)		
20	4.6		

Larvae data for fractioning

Production date code	Comments
19.2	Roasted larvae

Fractioning

Larvae IN (kg)	Press cake OUT (kg)	Crude oil OUT (hours)	Comments
20	14		

Cake grinding

Dry press cake IN (kg)	Meal OUT (kg)	Comments
14	14	

Oil refining

Crude oil IN (kg)	Oil OUT (kg)	Comments
4	2.5	

G

Annex G:

log sheet for daily data input of parameters in BSFL post-processing unit

Name responsible		Date code	
------------------	--	-----------	--

Drying method

Drying equipment used	
-----------------------	--

Drying data

Mass IN (kg)	Mass OUT (kg)	Drying time (minutes)	Comments
Total IN (kg)	TOTAL OUT (kg)		

Larvae data for fractioning

Production date code	Comments

Fractioning

Larvae IN (kg)	Press cake OUT (kg)	Crude oil OUT (hours)	Comments

Cake grinding

Dry press cake IN (kg)	Meal OUT (kg)	Comments

Oil refining

Crude oil IN (kg)	Oil OUT (kg)	Comments

Ventilation frame for stacking larveros units

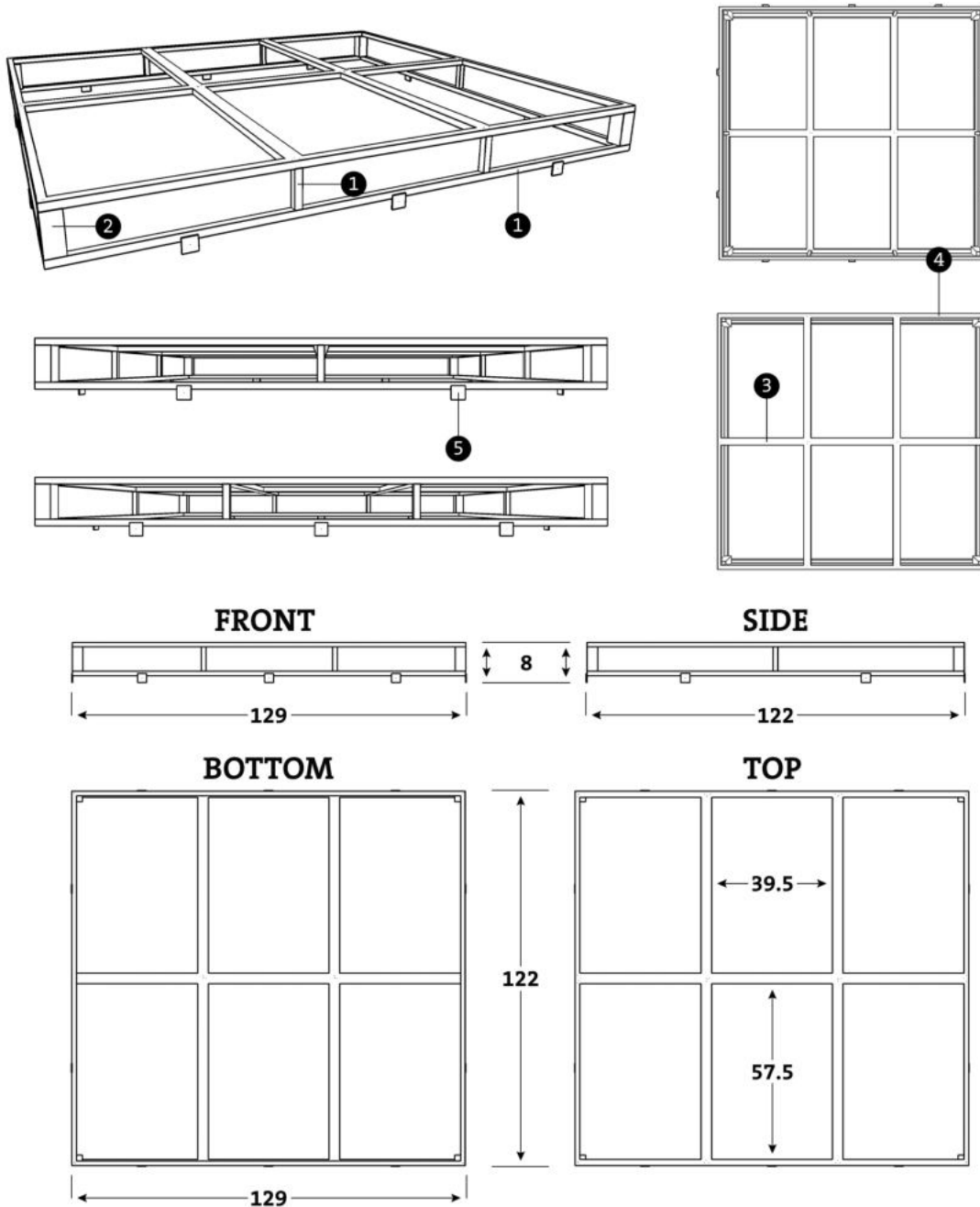

Material Used :

1. 1.75 x 1.75 cm Square steel hollow pipe
2. 3.5 x 3.5 cm Square steel hollow pipe
3. 3.5 x 1.75 cm Square steel hollow pipe
4. 2 x 1.75 cm Square steel hollow pipe
5. 3 cm Steel plate

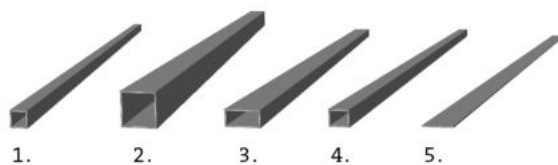

Frame for stacking incubator units

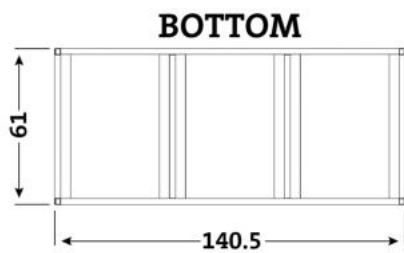
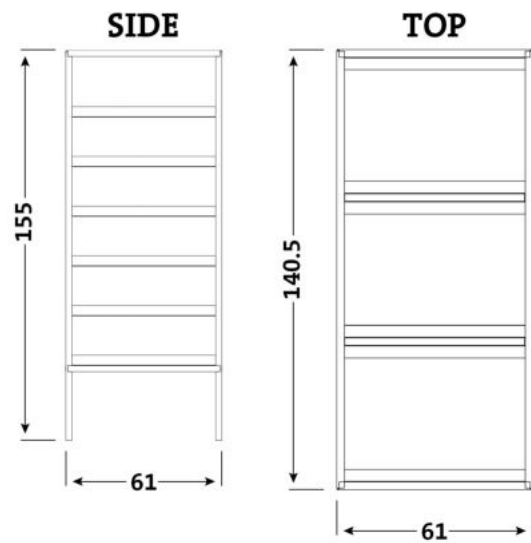
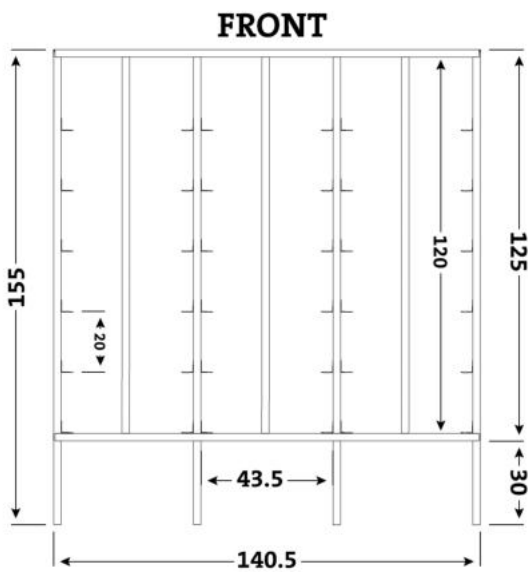
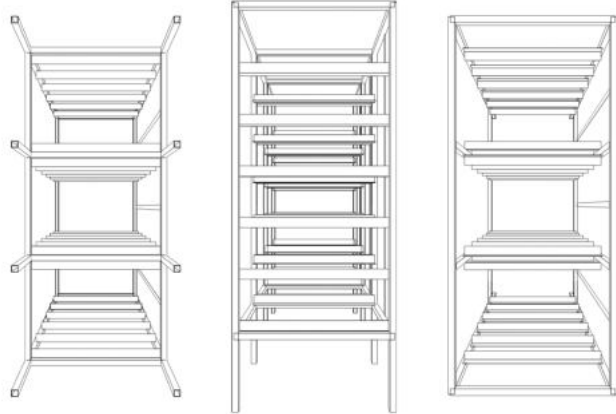
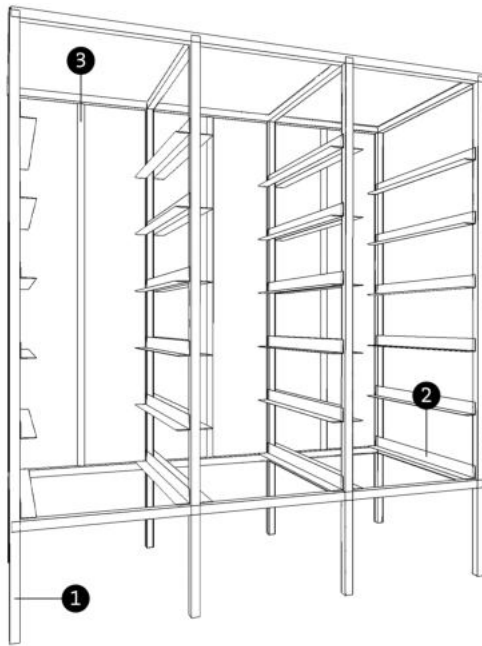

Material Used :

- 1. 2.5 x 2.5 cm Square steel hollow pipe
- 2. 4 cm Steel plate
- 3. 3 cm Steel plate

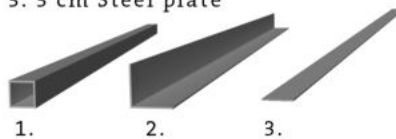

H

Annex H:

Frame for stacking pupation crates

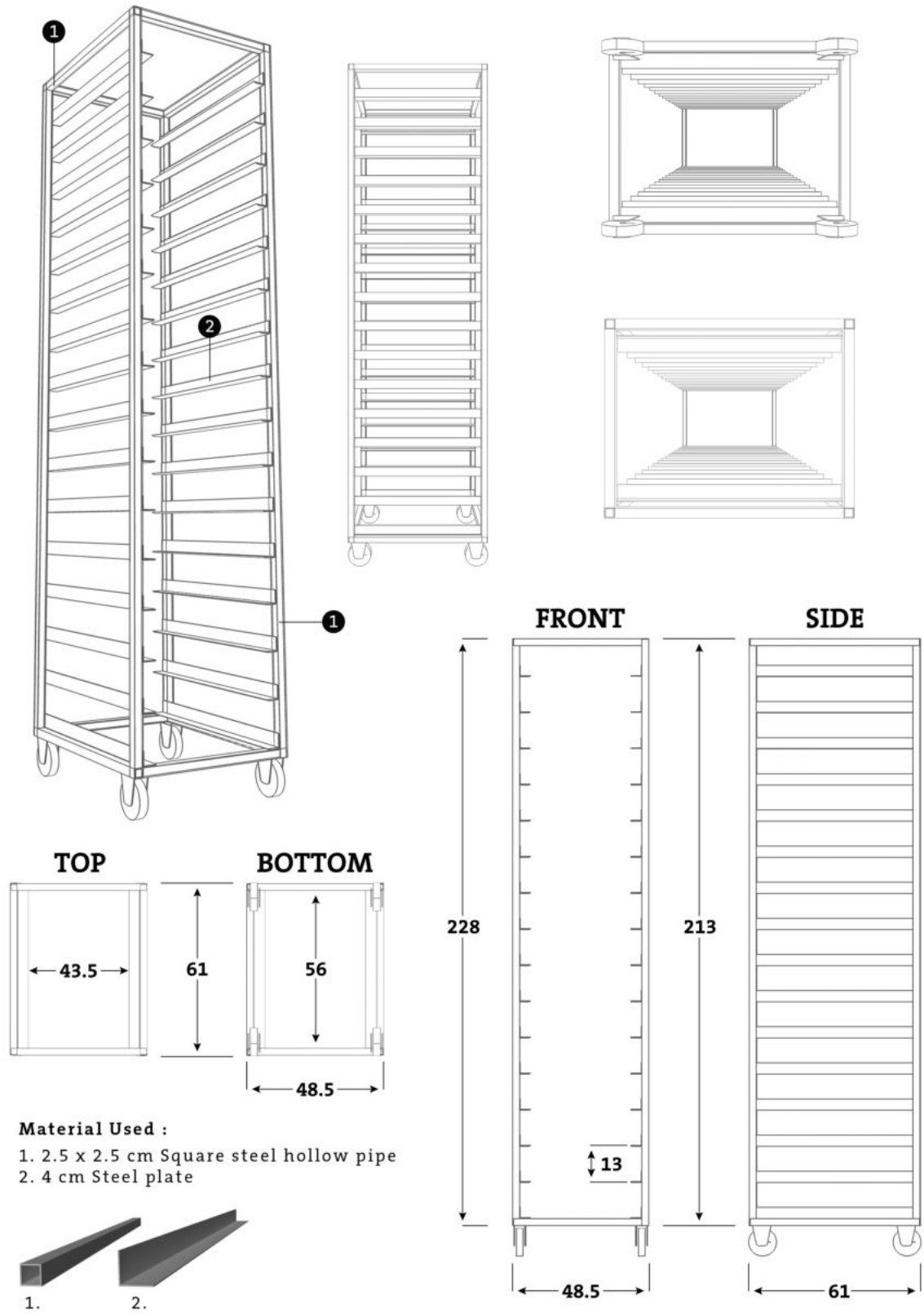

Frame for stacking nursery larveros

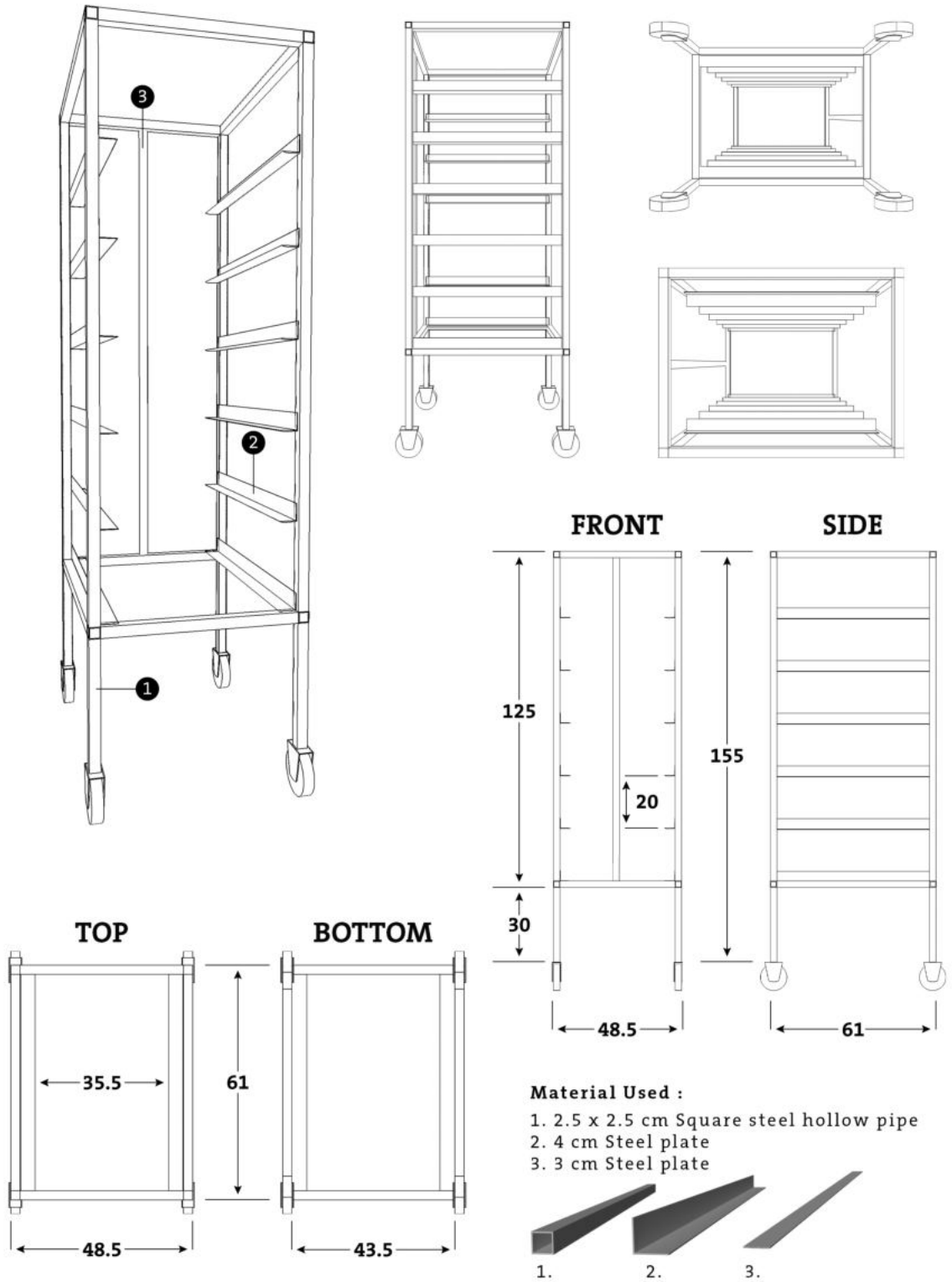

H

Annex H:

Hatchling shower frame

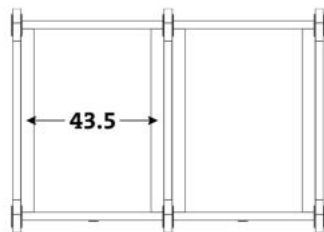
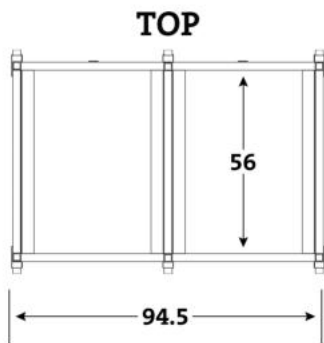
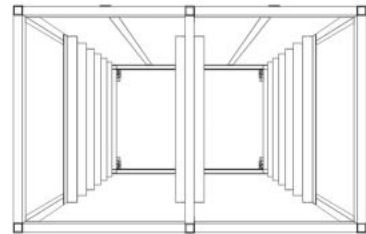
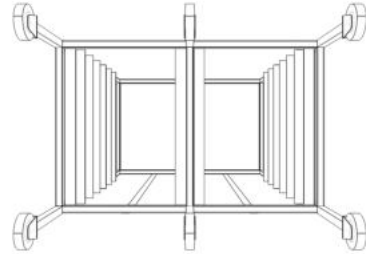
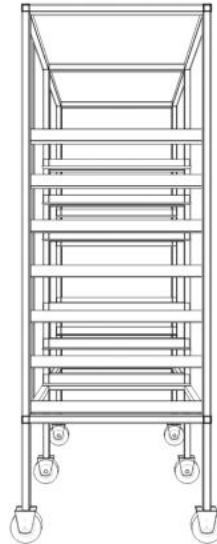
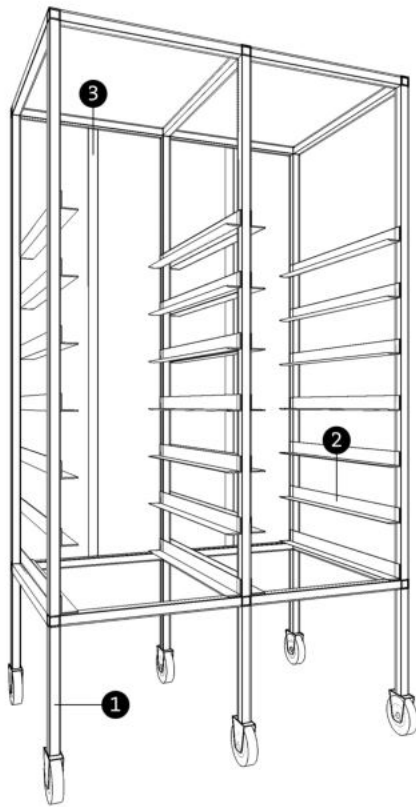

BOTTOM

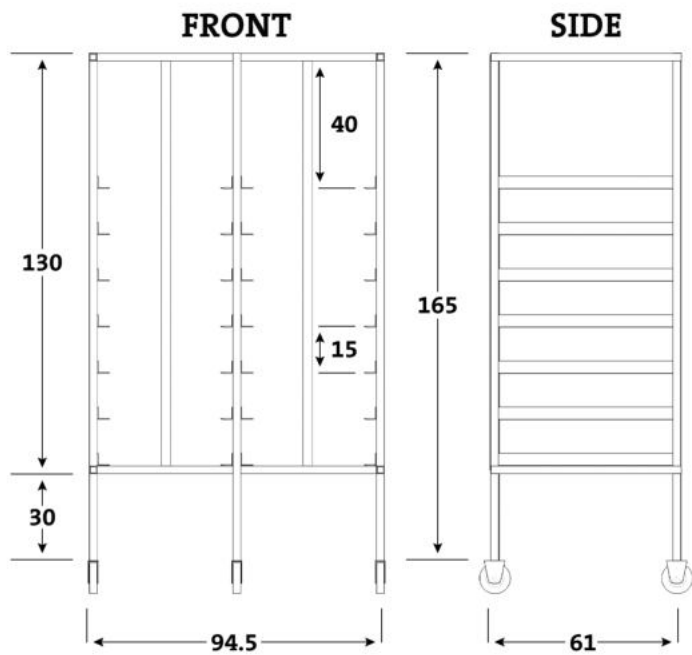

Material Used :

- 1. 2.5 x 2.5 cm Square steel hollow pipe
- 2. 4 cm Steel plate
- 3. 3 cm Steel plate

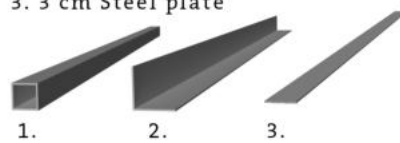

Mobile love cage transfer frame

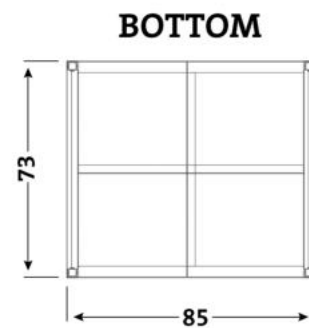
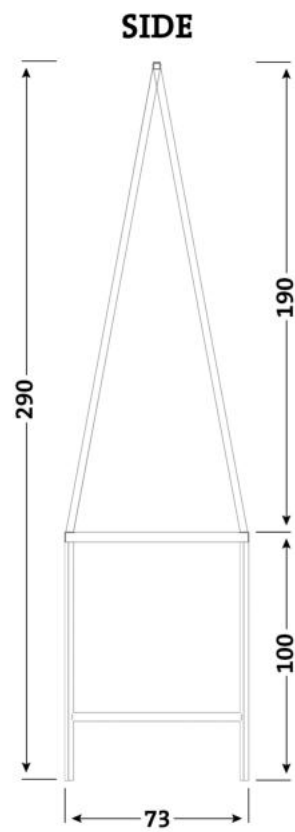
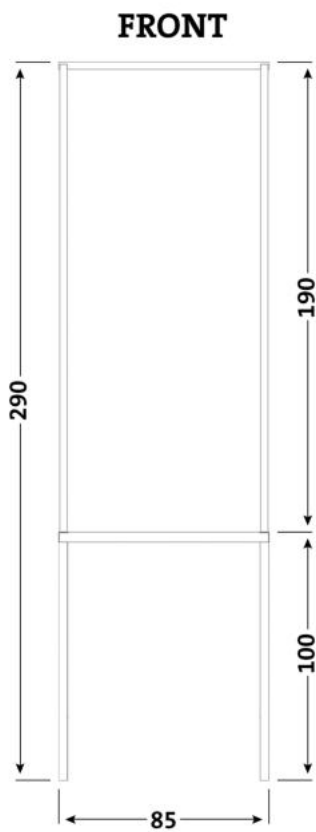
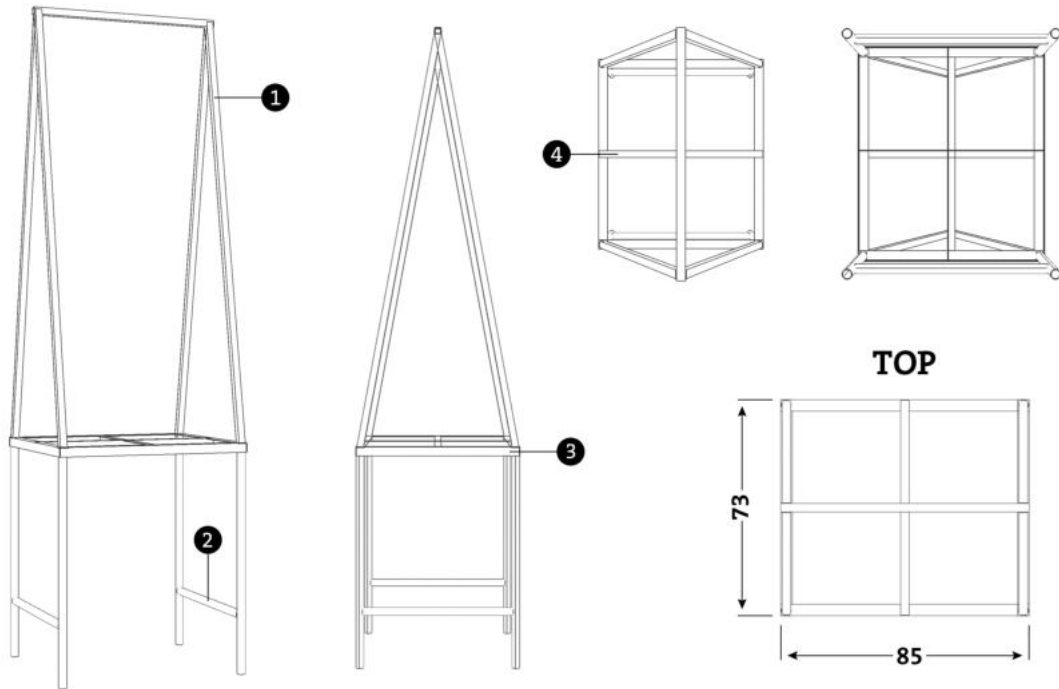

Material Used :

1. 3 x 3 cm Square steel hollow pipe
2. 3.5 cm Steel hollow pipe
3. 4 x 4 cm Steel plate
4. 3 x 3 cm Steel plate

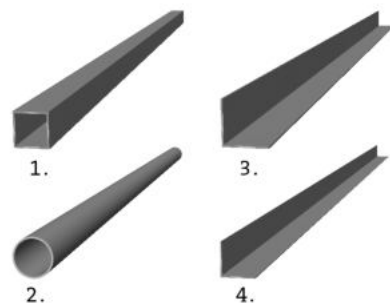

H

Annex H:

Love cage table frame

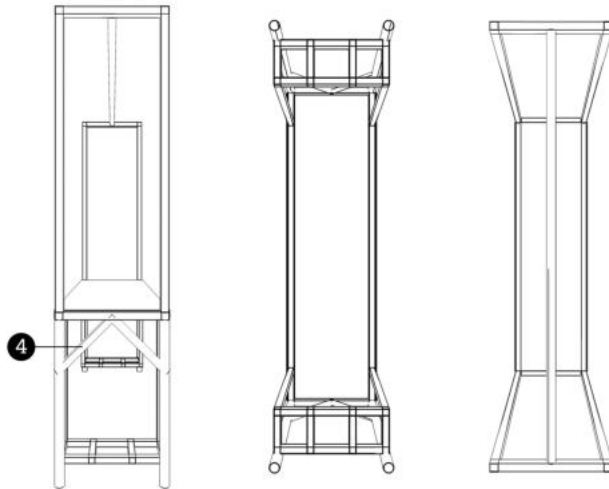
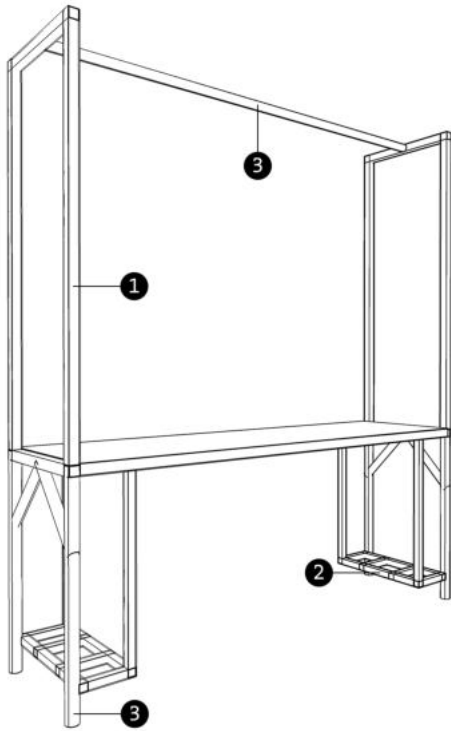

FRONT

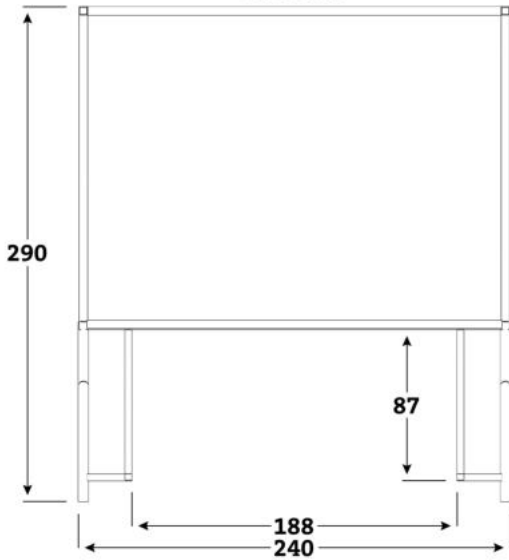

SIDE

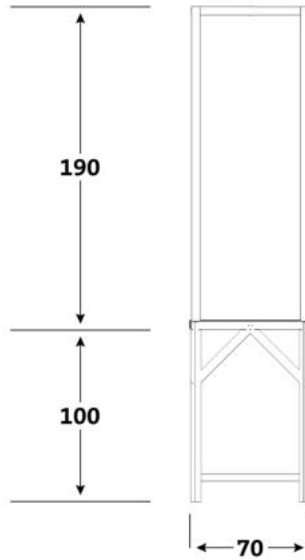

TOP

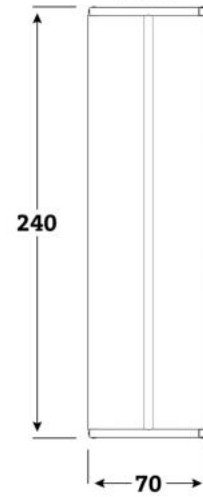

BOTTOM

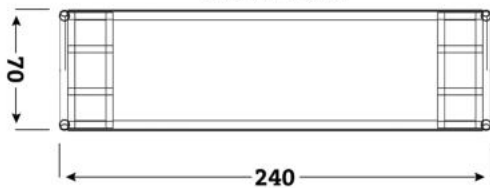

Material Used :

- 1. 2.5 x 2.5 cm Square steel hollow pipe
- 2. 2 x 2 cm Square steel hollow pipe
- 3. 3 cm Steel hollow pipe
- 4. 2.5 cm Steel hollow pipe



Dark cage table frame

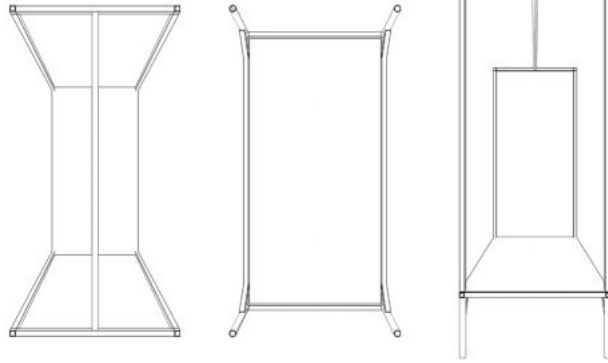
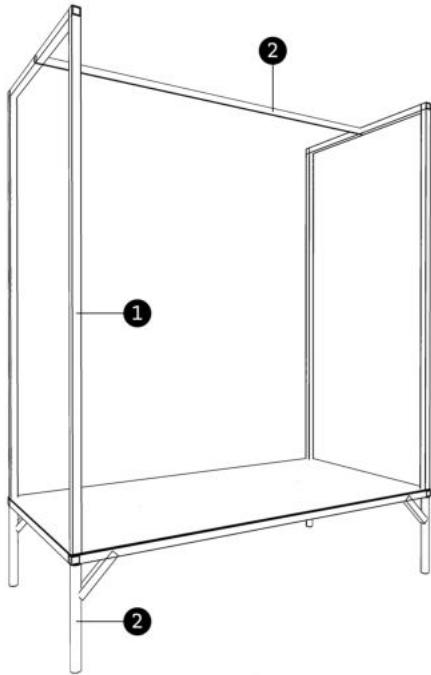

FRONT

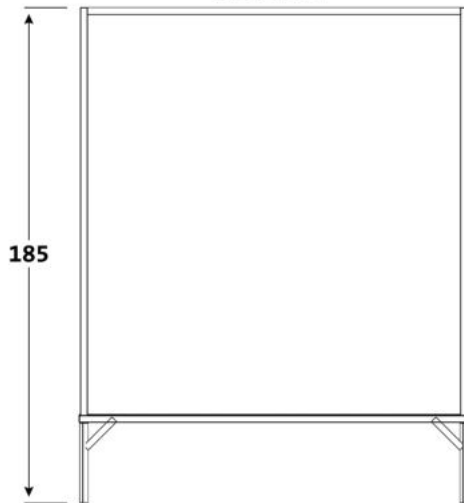

SIDE

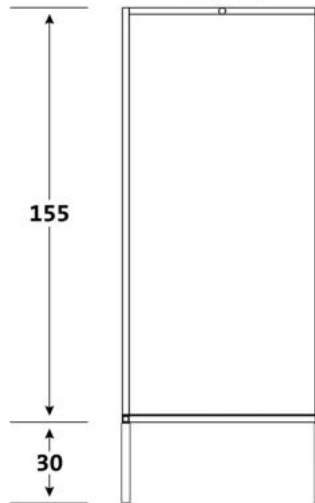

TOP

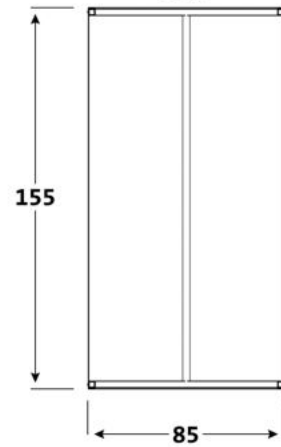

BOTTOM

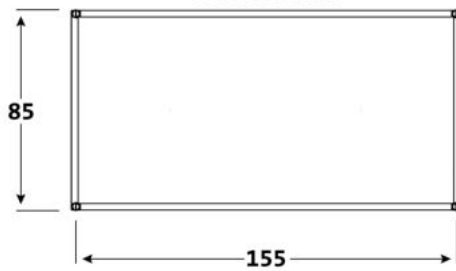

Material Used :

- 1. 2.5 x 2.5 cm Square steel hollow pipe
- 2. 3 cm Steel hollow pipe

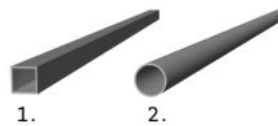

Love Cage

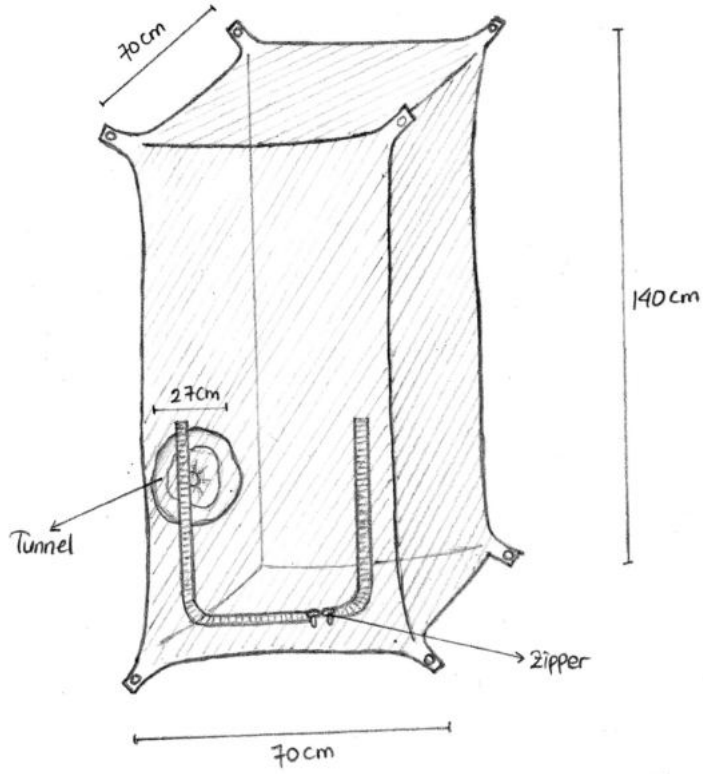

Dark Cage

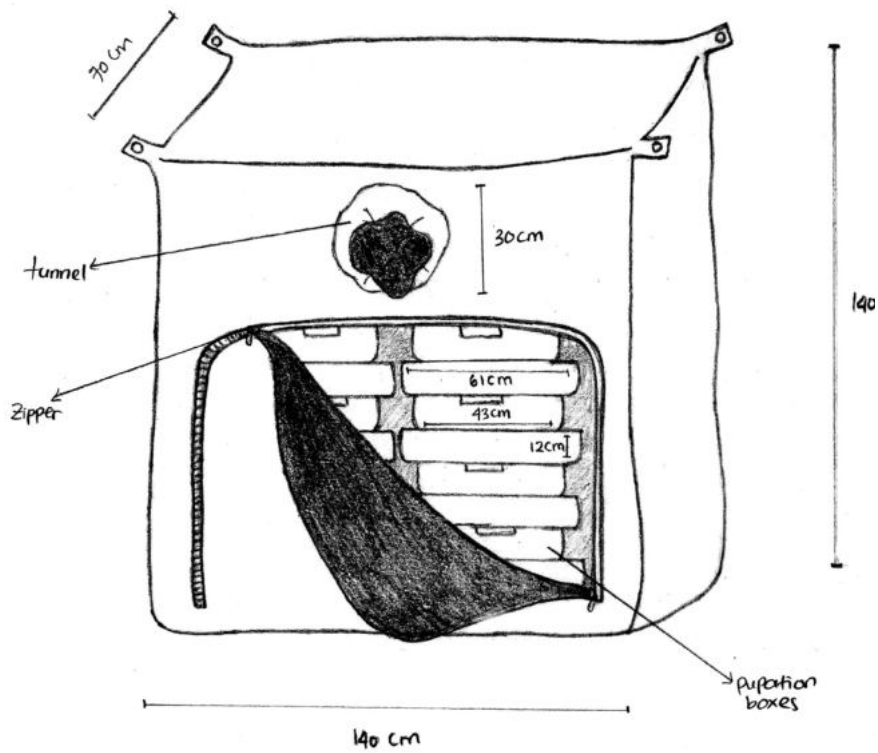

I

Annex I:

Overview of equipment required for a BSF biowaste processing plant with a capacity of 5 ton/d

Item name	Dimensions	Units required	Capacity / unit
BSF rearing unit			
Pupation crates	60 × 40 × 12	186	7,500 Prepupae/crate
Pupation frame	243 × 48.5 × 61	5	16 Crates/frame
Dark cage	140 × 140 × 70	8	16 Crates/cage
Dark cage frame	145 × 75 × 190	8	1 Cage/frame
Cement mixer	Max 350 kg	1	512 Crates/day/mixer
Love cage	140 × 70 × 70	29	8,000 Flies/cage
Egg media	25 × 5 × 3	290	10 Media/cage
Fly harvester	290 × 73 × 85	1	12 Dark cages/harvester
Love cage frame	289 × 240 × 70	10	3 Cages/frame
Hatchling crate	60 × 40 × 12	63	665,000 5-DOL/crate
Hatching shower frame	165 × 94.5 × 61	4	10 Crates/frame
Egg holder	D4.5	40	10 Holders/frame
Nursery Larvero	55 × 35 × 14	75	10,000 Larvae/Larvero
Collection container	60 × 40 × 12	75	1 Container/Larvero
Nursery larvero frame	155 × 48.5 × 61	12	6 Larvero+container/frame
Bulk storage bins	80L	6	5,000,000 5-DOL/triple set of bins
Working table	180 × 70 × 60	1	6 Larvero frames/table
Bulk scale	Max 150 kg	1	10,000,000 5-DOL/scale
Bulk balance	Max 35 kg	2	4,000,000 5-DOL/balance
Precision balance	Max 2 kg	4	2,000,000 5-DOL/balance
Washing machine	Max 5 kg	1	16 cages/washing machine
BSFL conversion unit			
Incubator units	30 × 20 × 10	3,875	1 kg waste/crate
Incubator holding crate	60 × 40 × 15	969	4 Incubator units/crate
Incubator frame	155 × 141 × 61	39	18 Holding crates/frame
Larvero units	60 × 40 × 15	3,875	11 kg waste/crate
Pallet	129 × 122 × 15	108	36 Crates/pallet
Ventilation frames	129 × 122 × 12	540	5 Frames per pallet
Pallet trolley	Max 2 ton	2	2,520 kg waste/trolley
Shredder	1 ton/hour	1	8,000 kg waste/shredder/day
Shaking sieve	1 ton/hour	1	3,150 kg residue/sieve/day
High pressure cleaner	-	2	2,520 kg waste/unit/day
Bulk scale	Max 150 kg	3	2,000 kg waste/unit/day
BSFL post-processing unit (only capacity provided, because quantity depends on product choice)			
Sanitising set	Custom made		120 kg fresh larvae / day
Kitchen microwave	32L		8 kg fresh larvae / day
Industrial microwave	Max-30B		210 kg fresh larvae / day
Wok pan for sand roasting	Custom made		24 kg fresh larvae / day
Drum dryer for roasting	Custom made		60 kg fresh larvae / day
Oven	Custom made		30 kg fresh larvae / day
Screw press	DL-ZYJ10B		40 kg dried larvae / day
Industrial screw press	ZX80		160 kg dried larvae / day
Grinder	AGR-GRP-180		480 kg press cake / day

Eawag
Überlandstrasse 133
8600 Dübendorf
Switzerland
Phone +41 (0)58 756 52 86
www.eawag.ch
www.sandec.ch

This book deals with urban organic municipal waste from households, commercial activities, and institutions. It describes the approach of biowaste conversion by insect larvae, using the example of the Black Soldier Fly (BSF), *Hermetia illucens*.

This engineered biosystem consists of feeding segregated biowaste to BSF larvae, which are reared in a nursery. Larvae grow on the waste feedstock and reduce its biomass. At the end of the process, larvae are harvested and, if necessary, post-processed to a suitable animal feed product. This guide is for practical use, explaining the required materials and equipment, as well as each working step similar to a cookbook with its respective recipes and materials required. It includes all information necessary to develop and operate a BSF waste processing facility, able to treat five tons of waste per day. This second edition of 2021 builds on the first version published in 2017. It includes our more recent experiences and describes developments and our updated suggestions. In particular, this second edition has new chapters on larvae post-processing and marketing of larvae products, on cost-analysis of BSF operations and respective facilities, and on information on site design and options of business models for BSF waste processing.

This second edition has benefited significantly from two projects. FORWARD is a R&D project located in Indonesia funded by the Swiss State Secretariat for Economic Affairs (SECO), under a framework agreement with the Indonesian Ministry of Public Works & Housing (PU-PeRa). It works in close collaboration with national and local governmental authorities, with Indonesian researchers and with selected private enterprises to advance and mainstream implementation of BSF waste processing. SIBRE is a research project funded by SwissRe Foundation with the objective to generate knowledge and tools around BSF waste processing for use by small & medium enterprises and municipalities. Its focus was set predominantly on the economic perspectives and developing standard protocols for products derived from BSF larvae and testing these in the Indonesia context.