

Biological Wastewater Treatment in Warm Climate Regions

Biological Wastewater Treatment in Warm Climate Regions

*Marcos von Sperling and
Carlos Augusto de Lemos Chernicharo*

*Department of Sanitary and Environmental Engineering
Federal University of Minas Gerais, Brazil*

VOLUME TWO

Associate editors (Part VII):
Cleverson Vitorio Andreoli and
Fernando Fernandes



Publishing
LONDON • SEATTLE



Published by IWA Publishing, Alliance House, 12 Caxton Street, London SW1H 0QS, UK

Telephone: +44 (0) 20 7654 5500; Fax: +44 (0) 20 7654 5555; Email: publications@iwap.co.uk

Website: www.iwapublishing.com

First published 2005

Reprinted 2006

© 2005 IWA Publishing

Copy-edited and typeset by TechBooks, India

Printed by TJ International, Padstow, UK

Apart from any fair dealing for the purposes of research or private study, or criticism or review, as permitted under the UK Copyright, Designs and Patents Act (1998), no part of this publication may be reproduced, stored or transmitted in any form or by any means, without the prior permission in writing of the publisher, or, in the case of photographic reproduction, in accordance with the terms of licences issued by the Copyright Licensing Agency in the UK, or in accordance with the terms of licenses issued by the appropriate reproduction rights organization outside the UK. Enquiries concerning reproduction outside the terms stated here should be sent to IWA Publishing at the address printed above.

The publisher makes no representation, expressed or implied, with regard to the accuracy of the information contained in this book and cannot accept any legal responsibility or liability for errors or omissions that may be made.

Disclaimer

The information provided and the opinions given in this publication are not necessarily those of IWA or of the editors, and should not be acted upon without independent consideration and professional advice. IWA and the editors will not accept responsibility for any loss or damage suffered by any person acting or refraining from acting upon any material contained in this publication.

British Library Cataloguing in Publication Data

A CIP catalogue record for this book is available from the British Library

Library of Congress Cataloguing-in-Publication Data

A catalogue record for this book is available from the Library of Congress

ISBN: 1 84339 002 7 (set); 1 84339 107 4 (this volume)

Contents

Volume Two

PART FIVE ACTIVATED SLUDGE

30	Activated sludge process and main variants	839
30.1	Introduction	839
30.2	Variants of the activated sludge process	842
31	Principles of organic matter removal in continuous-flow activated sludge systems	855
31.1	Preliminaries	855
31.2	Sludge age in activated sludge systems	857
31.3	Suspended solids concentration in the reactor	857
31.4	Calculation of the reactor volume	859
31.5	Substrate removal	862
31.6	Soluble BOD and total BOD in the effluent	865
31.7	Sludge digestion in the reactor	869
31.8	Recirculation of the activated sludge	872
31.9	Production and removal of excess sludge	877
31.10	Oxygen requirements	886
31.11	Nutrient requirements	893
31.12	Influence of the temperature	896
31.13	Functional relations with the sludge age	897
32	Design of continuous-flow activated sludge reactors for organic matter removal	906
32.1	Selection of the sludge age	906
32.2	Design parameters	908
32.3	Physical configuration of the reactor	909
32.4	Design details	912

33	Design of activated sludge sedimentation tanks	915
33.1	Types of sedimentation tanks	915
33.2	Determination of the surface area required for secondary sedimentation tanks	916
33.3	Design details in secondary sedimentation tanks	937
33.4	Design of primary sedimentation tanks	939
34	Design example of an activated sludge system for organic matter removal	942
34.1	Introduction	942
34.2	Model parameters and coefficients	943
34.3	Design of the conventional activated sludge system	944
34.4	Summary of the design	957
35	Principles of biological nutrient removal	959
35.1	Introduction	959
35.2	Nitrogen in raw sewage and main transformations in the treatment process	961
35.3	Principles of nitrification	965
35.4	Principles of biological denitrification	978
35.5	Principles of biological phosphorus removal	986
36	Design of continuous-flow systems for biological nutrient removal	997
36.1	Biological nitrogen removal	997
36.2	Biological removal of nitrogen and phosphorus	1015
37	Intermittent operation systems (sequencing batch reactors)	1023
37.1	Introduction	1023
37.2	Principles of the process	1023
37.3	Process variants	1026
37.4	Design criteria for sequencing batch reactors	1031
37.5	Design methodology for sequencing batch reactors	1034
37.6	Design example of a sequencing batch reactor	1035
38	Activated sludge for the post-treatment of the effluents from anaerobic reactors	1042
38.1	Design criteria and parameters	1042
38.2	Design example of an activated sludge system for the post-treatment of the effluent from a UASB reactor	1045
39	Biological selectors	1055
39.1	Introduction	1055
39.2	Types of selectors	1057
40	Process control	1061
40.1	Introduction	1061
40.2	Basic concepts of process control	1063

40.3	Dissolved oxygen control	1065
40.4	Solids control	1066
40.5	Monitoring the system	1073
41	Identification and correction of operational problems	1074
41.1	Introduction	1074
41.2	High concentrations of suspended solids in the effluent	1075
41.3	High BOD concentrations in the effluent	1098
41.4	High ammonia concentrations in the effluent	1103

PART SIX AEROBIC BIOFILM REACTORS

42	Basic principles of aerobic biofilm reactors <i>R.F. Gonçalves</i>	1113
42.1	Introduction	1113
42.2	Classification of aerobic biofilm reactors	1114
42.3	Formation, structure and behaviour of biofilms	1115
43	Trickling filters <i>C.A.L. Chernicharo, R.F. Gonçalves</i>	1119
43.1	Description of the technology	1119
43.2	Design criteria	1123
43.3	Construction aspects	1130
43.4	Operational aspects	1131
44	Rotating biological contactors <i>R.F. Gonçalves</i>	1135
44.1	Introduction	1135
44.2	Description of the technology	1135
44.3	Design criteria	1137
44.4	Construction aspects and characteristics of the support medium	1140
45	Submerged aerated biofilters <i>R.F. Gonçalves</i>	1142
45.1	Introduction	1142
45.2	Description of the technology	1142
45.3	Design criteria	1150
45.4	Construction aspects	1152
45.5	Operational aspects	1153

PART SEVEN SLUDGE TREATMENT AND DISPOSAL

46	Introduction to sludge management <i>M. von Sperling, C.V. Andreoli</i>	1167
----	--	------

47	Sludge characteristics and production	1170
	<i>M. von Sperling, R.F. Gonçalves</i>	
47.1	Sludge production in wastewater treatment systems	1170
47.2	Sludge characteristics at each treatment stage	1172
47.3	Fundamental relationships in sludge	1178
47.4	Calculation of the sludge production	1182
47.5	Mass balance in sludge treatment	1194
48	Main contaminants in sludge	1197
	<i>S.M.C.P. da Silva, F. Fernandes, V.T. Soccol, D.M. Morita</i>	
48.1	Introduction	1197
48.2	Metals	1198
48.3	Trace organics	1205
48.4	Pathogenic organisms	1206
49	Sludge stabilisation	1214
	<i>M. Luduvic</i>	
49.1	Introduction	1214
49.2	Anaerobic digestion	1215
49.3	Aerobic digestion	1233
50	Sludge thickening and dewatering	1242
	<i>R.F. Gonçalves, M. Luduvic, M. von Sperling</i>	
50.1	Thickening and dewatering of primary and biological sludges	1242
50.2	Sludge thickening	1244
50.3	Sludge conditioning	1247
50.4	Overview on the performance of the dewatering processes	1256
50.5	Sludge drying beds	1257
50.6	Centrifuges	1265
50.7	Filter press	1273
50.8	Belt presses	1280
50.9	Thermal drying	1284
51	Pathogen removal from sludge	1286
	<i>M.T. Pinto</i>	
51.1	Introduction	1286
51.2	General principles	1287
51.3	Mechanisms to reduce pathogens	1289
51.4	Processes to reduce pathogens	1293
51.5	Operation and control	1310
52	Assessment of sludge treatment and disposal alternatives	1315
	<i>F. Fernandes, D.D. Lopes, C.V. Andreoli, S.M.C.P. da Silva</i>	
52.1	Introduction	1315
52.2	Sustainable point of view	1316
52.3	Trends in sludge management in some countries	1316

52.4	Aspects to be considered prior to the assessment of alternatives	1318
52.5	Criterion for selecting sludge treatment and final disposal alternatives	1321
52.6	Sludge management at the treatment plant	1326
53	Land application of sewage sludge <i>C.V. Andreoli, E. S. Pegorini, F. Fernandes, H.F. dos Santos</i>	1328
53.1	Introduction	1328
53.2	Beneficial use	1329
53.3	Requirements and associated risks	1335
53.4	Handling and management	1343
53.5	Storage, transportation and application of biosolids	1352
53.6	Operational aspects of biosolid land application	1357
53.7	Landfarming	1367
54	Sludge transformation and disposal methods <i>M. Luduvic, F. Fernandes</i>	1373
54.1	Introduction	1373
54.2	Thermal drying	1374
54.3	Wet air oxidation	1375
54.4	Incineration	1378
54.5	Landfill disposal	1381
55	Environmental impact assessment and monitoring of final sludge disposal <i>A. I. de Lara, C.V. Andreoli, E.S. Pegorini</i>	1392
55.1	Introduction	1392
55.2	Potentially negative environmental impacts	1393
55.3	Monitoring indicators and parameters	1396
55.4	Monitoring plan	1398
	<i>Index</i>	1409

PART FIVE

Activated sludge

30	Activated sludge process and main variants	839
31	Principles of organic matter removal in continuous-flow activated sludge systems	855
32	Design of continuous-flow activated sludge reactors for organic matter removal	906
33	Design of activated sludge sedimentation tanks	915
34	Design example of an activated sludge system for organic matter removal	942
35	Principles of biological nutrient removal	959
36	Design of continuous-flow systems for biological nutrient removal	997
37	Intermittent operation systems (sequencing batch reactors)	1023
38	Activated sludge for the post-treatment of the effluents from anaerobic reactors	1042
39	Biological selectors	1055
40	Process control	1061
41	Identification and correction of operational problems	1074
	References	1103

30

Activated sludge process and main variants

30.1 INTRODUCTION

The activated sludge process is widely used around the world for the treatment of domestic and industrial wastewater, in situations where high effluent quality is necessary and space availability is limited. However, the activated sludge system is more heavily mechanised than the other treatment systems, involving a more sophisticated operation. Another disadvantage is the consumption of electrical energy for aeration.

To date, the largest application of the activated sludge system has been as a direct treatment of domestic or industrial effluents. More recently, the option of using the activated sludge system for the post-treatment of the effluent from anaerobic reactors is being investigated and used, by virtue of its various advantages. These are mainly associated with lower energy consumption and lower sludge production, while the effluent quality is comparable to that of the conventional activated sludge system.

The present chapter describes the main configurations of the activated sludge system, with its advantages, disadvantages and applicability.

The following units are integral parts and the essence of any continuous-flow activated sludge system (Figure 30.1):

- aeration tank (reactor)
- settling tank (secondary sedimentation tank)

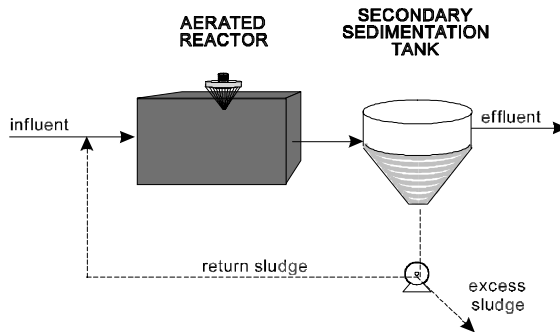

Figure 30.1. Representation of the main units in the biological stage of the activated sludge system

- sludge recirculation
- excess sludge removal

The biochemical reactions associated with the removal of the organic matter and, under certain conditions the nitrogenous matter, take place in the biological reactor (also called aeration tank). The biomass develops by using the substrate present in the influent sewage. The settling of the solids (biomass), which leads to a clarified final effluent, occurs in the secondary sedimentation tank. A part of the solids that settle in the bottom of the secondary sedimentation tank is recirculated to the reactor (*return sludge*), to maintain a large biomass concentration in the reactor, which is responsible for the high efficiency of the system. The other part of the solids (*excess sludge*, also called *surplus sludge*, *secondary sludge*, *biological sludge* or *waste sludge*) is withdrawn from the system and is directed to the sludge treatment stage.

The biomass is separated in the secondary sedimentation tank due to its property of flocculating and settling. This is due to the production of a gelatinous matrix, which allows the agglutination of the bacteria, protozoa and other microorganisms responsible for the removal of the organic matter, into macroscopic flocs. The flocs individually are much larger than the microorganisms, which facilitates their sedimentation (Figure 30.2).

As a result of the recirculation of the sludge, the concentration of suspended solids in the aeration tank in the activated sludge systems is very high. In the activated sludge process, the detention time of the liquid (hydraulic detention time) is short, in the order of hours, which implies that the volume of the aeration tank is much reduced. However, the solids remain in the system for a longer period than the liquid, due to the recirculation. The retention time of the solids in the system is denominated *mean cell residence time (MCRT)*, *solids retention time (SRT)* or *sludge age* (θ_c), and is defined as the ratio between the mass of biological sludge present in the reactor and the mass of biological sludge removed from (or produced in) the activated sludge system per day. It is this larger permanence of the solids in the system that guarantees the high efficiency of the activated sludge systems,

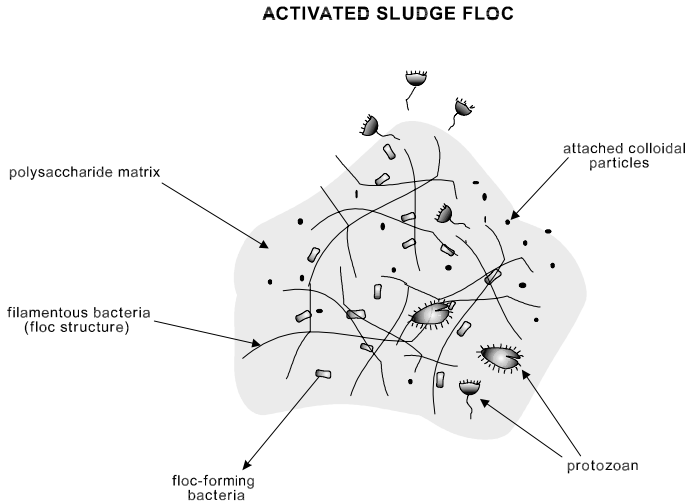

Figure 30.2. Schematic representation of an activated sludge floc

since the biomass has enough time to metabolise practically all the organic matter in the sewage.

Another practical parameter used for the activated sludge process is the food/microorganism ratio (**F/M ratio**), which is defined as the load of food or substrate (BOD) supplied per day per unit biomass in the reactor (represented by MLVSS – mixed liquor volatile suspended solids), and expressed as kgBOD/kgMLVSS·d. Since the microorganisms have a limited capacity to consume the substrate (BOD) per unit time, a high F/M ratio can mean a larger offer of biodegradable organic matter than the consumption capacity of the biomass in the system, resulting in surplus substrate in the final effluent. On the other hand, low F/M values mean that the substrate offer is lower than the microorganisms' capacity to use it in the activated sludge system. As a consequence, they will consume practically all the organic matter from the influent wastewater, as well as their own organic cellular material. High sludge ages are associated with low F/M values, and vice versa. The concepts of sludge age and F/M ratio are detailed in Chapter 9.

For comparison purposes, anaerobic UASB (upflow anaerobic sludge blanket) reactors also have biomass retention in the reaction compartment, where a sludge blanket is developed, receiving the influent sewage and part of the recirculation of the biomass. This recirculation is attained through sedimentation of the solids in the settling compartment, followed by return by simple gravity to the reaction compartment. On the other hand, in the activated sludge system this recirculation of the solids is obtained by means of pumping (continuous-flow activated sludge) or by switching on and off the aerators (sequencing batch activated sludge reactors, described in Section 30.2.4). As a result, both in the UASB reactor and in the activated sludge system, the time of permanence of the biomass is longer than that

of the liquid, guaranteeing the high compactness of the systems associated with their high efficiency.

Due to the continuous input of substrate (BOD from influent sewage) into the aeration tank, the microorganisms grow and continually reproduce. If the microorganisms were allowed to grow indefinitely, they would tend to reach excessive concentrations in the aeration tank, hindering the transfer of oxygen to all the bacterial cells. Besides, the secondary sedimentation tank would be overloaded, and the solids would not be able to settle satisfactorily and would be lost in the final effluent, thus deteriorating its quality. To maintain the system in balance, it is necessary to remove the same amount of biomass that is increased by reproduction. This is the *biological excess sludge*, which can be extracted directly from the reactor or from the return sludge line.

In the *conventional activated sludge system*, the excess sludge needs to undergo additional treatment in the sludge treatment line, usually comprising thickening, digestion and dewatering. The digestion is to decrease the amount of biodegradable bacterial mass (that is also organic matter) that could otherwise render the sludge septic in its final disposal. When activated sludge is used as *post-treatment for the effluent from anaerobic reactors*, due to the fact that a great part of the organic matter has already been removed in the anaerobic stage, the aerobic biomass growth in the activated sludge is lower (less substrate available). In this variant, the sludge production is, therefore, lower. The treatment of the sludge is also very simplified, since the aerobic excess sludge from the activated sludge can be returned to the UASB reactor, where it undergoes digestion and thickening.

The activated sludge system can be adapted to include the biological removal of *nitrogen* and *phosphorus*, now widely applied in several countries (see Chapters 35 and 36).

Regarding the removal of *coliforms* and pathogenic organisms, the efficiency is low and usually insufficient to meet the quality requirements of receiving water bodies, due to the reduced detention time in the units. This lower efficiency is also typical of other compact wastewater treatment processes. In case it is necessary, the effluent should be subjected to a subsequent disinfection stage. Due to the good quality of the effluent, the chlorine demand for disinfection is small: a concentration of a few mg/L of chlorine or its derivatives is enough for a substantial elimination of pathogens in a few minutes. As in every wastewater chlorination system, the possible need for dechlorination should be analysed for the reduction of the residual chlorine concentration, because of its toxicity to the receiving body biota. UV radiation is also attractive, due to the low level of suspended solids in the effluent from the activated sludge systems.

30.2 VARIANTS OF THE ACTIVATED SLUDGE PROCESS

30.2.1 Preliminaries

There are several variants of the activated sludge process. The present chapter focuses only on the main and more commonly used ones, which can be classified

Table 30.1. Classification of the activated sludge systems as a function of the sludge age and F/M ratio

Sludge age	Sludge age (day)	F/M ratio (kgBOD/kgMLVSS·day)	Usual designation
Low	4 to 10	0.25 to 0.50	Conventional activated sludge
High	18 to 30	0.07 to 0.15	Extended aeration

according to the following characteristics:

- division according to the sludge age (or F/M ratio)
 - conventional activated sludge (low sludge age, high F/M ratio)
 - extended aeration (high sludge age, low F/M ratio)
- division according to the flow
 - continuous flow
 - intermittent flow (sequencing batch reactors)
- division according to the influent to the biological stage of the activated sludge system
 - raw sewage
 - effluent from a primary sedimentation tank
 - effluent from an anaerobic reactor
 - effluent from another wastewater treatment process

There are other variants, related to the physical configuration of the aeration tank and the position of the inlets, but these are covered in Chapter 32.

The activated sludge systems can be classified in terms of the sludge age and the F/M ratio in one of the main categories listed in Table 30.1.

This classification according to the sludge age is applicable to both *continuous flow systems* (liquid entering and leaving the activated sludge reactor continuously) and *intermittent flow* or *sequencing batch systems* (intermittent input of the liquid in each activated sludge reactor). However, the extended aeration variant is more frequent for the intermittent flow systems. Regarding the activated sludge system acting as post-treatment for the effluent from anaerobic reactors, the most convenient option is the one with the reduced (conventional) sludge age.

Systems with very low sludge age (less than 4 days), also designated *modified aeration*, are less commonly used. Especially in warm-climate regions, the reactor volume would be very small, which could lead to some hydraulic instabilities in the system. In warm-climate areas, systems with *intermediate sludge ages* (between 10 and 18 days) do not present advantages for their use, since they do not enable a substantial increase in BOD removal, compared to the conventional sludge age, and they do not obtain the aerobic stabilisation of the sludge, which is a characteristic of the extended aeration. In temperate climate countries, the adoption of sludge ages of over 10 days can be necessary to reach complete nitrification throughout the year.

The biological stage of activated sludge (biological reactor and secondary sedimentation tank) can receive *raw wastewater* (usually in the extended aeration variant), *effluent from primary sedimentation tanks* (a classic conception of conventional activated sludge), *effluent from anaerobic reactors* (recent development) and *effluent from other wastewater treatment processes* (such as physical–chemical treatment or coarse trickling filters, for additional effluent polishing).

30.2.2 Conventional activated sludge (continuous flow)

To save energy for aeration and to reduce the volume of the biological reactor in the conventional system, part of the organic matter (suspended, settleable) from the wastewater is removed before the aeration tank, in the primary sedimentation tank. Thus, conventional activated sludge systems have primary treatment as an integral part of their flowsheet (Figure 30.3). In the figure, the top part corresponds to the treatment of the liquid phase (wastewater), while the bottom part exemplifies the stages involved in the treatment of the solid phase (sludge).

In the conventional system, the sludge age is usually of the order of 4 to 10 days, the F/M ratio is in the range of 0.25 to 0.50 kgBOD/kgMLVSS-d and the hydraulic detention time in the reactor is of the order of 6 to 8 hours. With this sludge age, the biomass removed from the system in the excess sludge still requires stabilisation

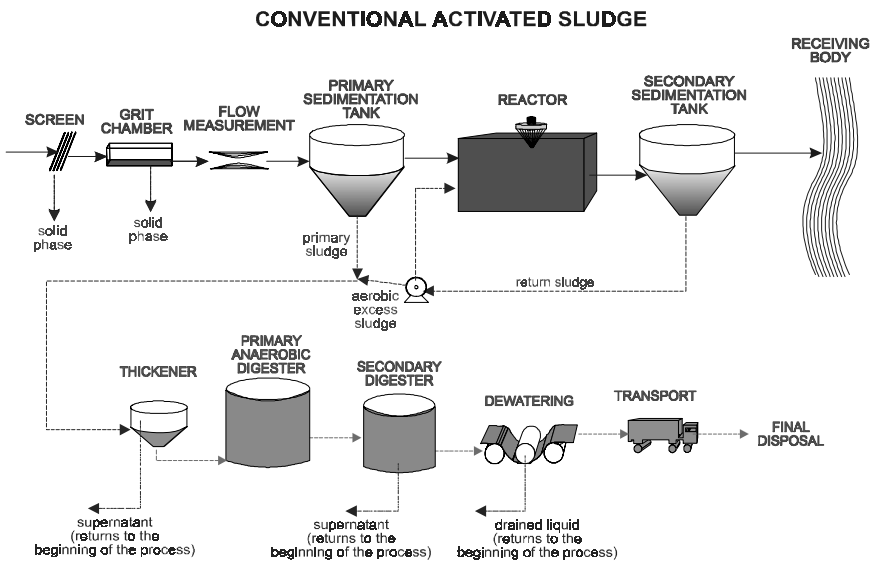

Figure 30.3. Typical flowsheet of the conventional activated sludge system

in the sludge treatment stage, since it still contains a high level of biodegradable organic matter in its cells. This stabilisation takes place in the digesters. To reduce the volume of the digesters, the sludge is previously subjected to a thickening stage, in which part of the water content is removed, thereby decreasing the sludge volume to be treated.

30.2.3 Extended aeration (continuous flow)

If the biomass stays in the system for longer periods, in the order of 18 to 30 days (hence the name *extended aeration*), and receives the same BOD load from the raw wastewater as in the conventional system, there will be less substrate available for the bacteria (F/M ratio of only 0.07 to 0.15 kgBOD/kgMLVSS·d). The amount of biomass (kgMLVSS) is larger than that in the conventional activated sludge system, the volume of the aerobic reactor is also higher and the detention time of the liquid is around 16 to 24 hours. Therefore, there is less organic matter per unit volume of the aeration tank and per unit biomass in the reactor. Consequently, to survive, the bacteria start to use in their metabolic processes their own biodegradable organic matter, which is a component of their cells. This cellular organic matter is transformed into carbon dioxide and water through respiration. This corresponds to an aerobic stabilisation of the biomass in the aeration tank. While in the conventional activated sludge system the stabilisation of the sludge is done separately (in the sludge digesters in the sludge treatment stage, usually in an anaerobic environment), in the extended aeration the sludge digestion is done jointly in the reactor, in an aerobic environment. The additional consumption of oxygen for the sludge stabilisation (endogenous respiration) is significant and it can be larger than the consumption for the assimilation of the organic matter from the influent (exogenous respiration).

Since there is no need to stabilise the excess biological sludge, the generation of another type of sludge is avoided in the extended aeration system, since this sludge would require subsequent separate stabilisation. For this reason, the extended aeration systems usually do not have primary sedimentation tanks, to avoid the need for a separate stabilisation of the primary sludge. With this, a great simplification in the process flowsheet is obtained: there are no primary sedimentation tanks or sludge digestion units (Figure 30.4).

The consequence of this simplification in the system is the increase in the energy consumption for aeration, since the sludge is stabilised aerobically in the aeration tank. On the other hand, the reduced substrate availability and its practically total assimilation by the biomass make the extended aeration variant one of the most efficient wastewater treatment processes for the removal of BOD.

However, it should be stressed that the efficiency of any variant of the activated sludge process is intimately associated with the performance of the secondary sedimentation tank. If there is a loss of solids in the final effluent, there will be a large deterioration in the effluent quality, independent of a good performance of the aeration tank in the BOD removal.

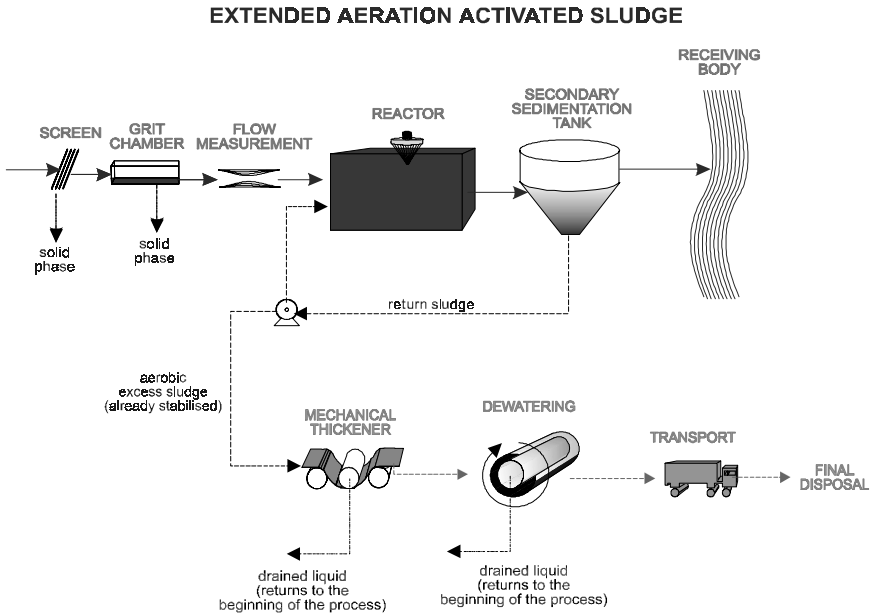

Figure 30.4. Typical flowsheet of an extended aeration system

30.2.4 Intermittent operation (sequencing batch reactors)

The activated sludge systems described in Sections 30.2.2 and 30.2.3 are of *continuous flow* in relation to the wastewater, that is to say, the liquid is always entering and leaving the reactor. There is, however, a variant of the system with an *intermittent flow* operation, also called a *sequencing batch reactor*.

The principle of the activated sludge process with intermittent operation consists of the incorporation of all the units, processes and operations usually associated with the traditional activated sludge treatment, namely, primary settling, biological oxidation and secondary settling, in a single tank. In this tank, those processes and operations simply become sequences in time, and not separated units as in the conventional continuous-flow processes. The process of activated sludge with intermittent flow can be used both in the conventional and in the extended aeration modes, although the latter is more common, due to its greater operational simplicity. In the extended aeration mode, the single tank also incorporates a sludge digestion (aerobic) function. Figure 30.5 illustrates the flowsheet of a sequencing batch reactor system.

The process consists of a complete-mix reactor where all the treatment stages occur. That is obtained through the establishment of operational cycles and phases, each with a defined duration. The biomass is retained in the reactor during all phases, thus eliminating the need for separate settling tanks. A normal treatment

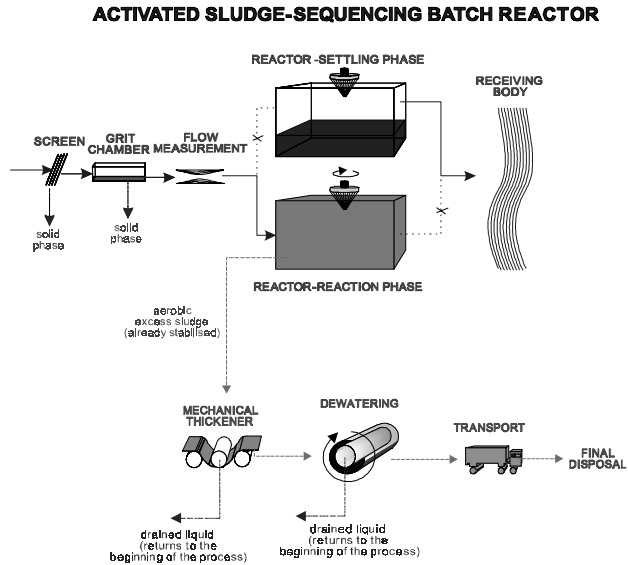

Figure 30.5. Typical flowsheet of an activated sludge system with intermittent operation (two reactors)

cycle is composed of the following phases:

- *filling* (input of raw or settled sewage to the reactor)
- *reaction* (aeration/mixing of the liquid contained in the reactor)
- *settling* (settling and separation of the suspended solids from the treated sewage)
- *withdrawal* (removal of the treated sewage from the reactor)
- *idle* (adjustment of cycles and removal of the excess sludge)

The usual duration of each phase and the overall cycle can be altered according to the influent flow variations, the treatment requirements, and the characteristics of the sewage and the biomass in the system.

Because sewage is continuously entering the treatment plant, more than one reactor is required: when one reactor is in the settling phase, no influent is allowed. Therefore, the influent is diverted to another reactor, which is in the fill stage.

The flowsheet of the process is largely simplified, due to the elimination of several units, compared to the continuous-flow activated sludge systems. In the extended aeration mode in the sequencing batch reactors, the only units of all the treatment processes (liquid and sludge) are: *screens, grit chambers, reactors, sludge thickeners (optional) and sludge dewatering units.*

There are some variants in the intermittent flow systems related to the operational procedure (continuous feeding and discontinuous emptying) and the sequence and duration of the cycles associated with each phase of the process. These

variants can have additional simplifications in the process or incorporate the biological removal of nutrients, and are described in Chapter 37.

30.2.5 Activated sludge for the post-treatment of effluents from anaerobic reactors

A very promising alternative in warm-climate regions, which is the focus of recent research and is beginning to be implemented in full scale, is the one of activated sludge (with the conventional sludge age of 6 to 10 days) as a post-treatment of the effluent from anaerobic UASB-type reactors. In this case, there is an anaerobic reactor instead of a primary sedimentation tank. The excess aerobic sludge generated in the activated sludge system, not yet stabilised, is directed to the UASB reactor, where it undergoes thickening and digestion, together with the anaerobic sludge. As this aerobic excess sludge flow is very low, compared with the influent flow, there are no operational disturbances to the UASB reactor. The treatment of the sludge is largely simplified: thickeners and digesters are not needed, and there is only the dewatering stage. The mixed sludge withdrawn from the anaerobic reactor is digested and has similar concentrations to that of a thickened sludge, and also has excellent dewatering characteristics. Figure 30.6 shows the flowsheet for this configuration.

A comparison of this configuration with the traditional concept of the conventional activated sludge system is presented in Table 30.2.

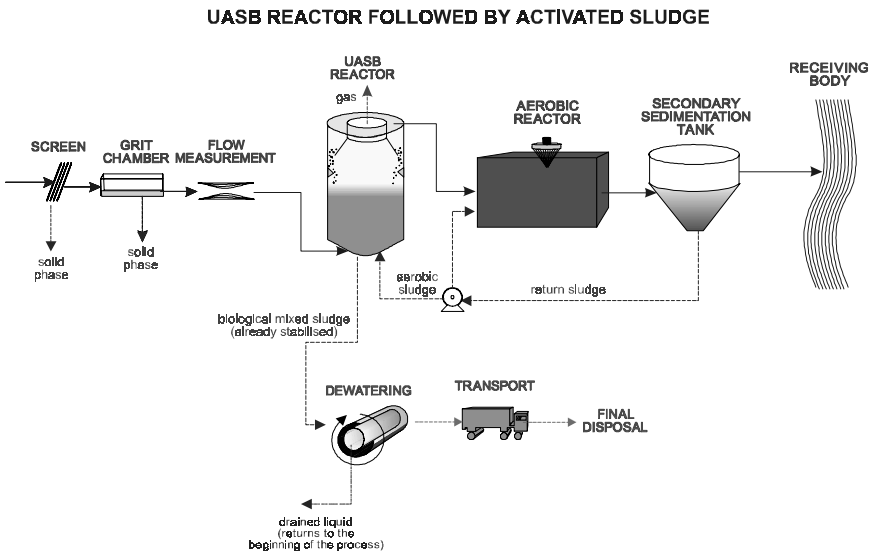

Figure 30.6. Flowsheet of a system composed of a UASB reactor followed by an activated sludge system

Table 30.2. Main advantages, disadvantages and similarities of the UASB-activated sludge system with relation to the traditional concept of the conventional activated sludge system

Aspect	Item	Remark
Advantage	Reduction in the sludge production	<ul style="list-style-type: none"> • The mass of sludge produced and to be treated is of the order of 40 to 50% of the total value produced in the traditional concept of the conventional activated sludge, and 50 to 60% of the total produced in the extended aeration mode • The mass for final disposal is of the order of 60 to 70% of that from the traditional concepts • The reduction in the sludge volume is still larger, due to the fact that the mixed anaerobic sludge is more concentrated and has very good dewaterability
	Reduction in the energy consumption	<ul style="list-style-type: none"> • Since approximately 70% of the BOD is previously removed in the UASB reactor, the oxygen consumption is only for the remaining BOD and for nitrification, which in this case is the prevailing factor in the oxygen consumption (around 2/3 of the total consumption)
	Reduction in the total volume of the units	<ul style="list-style-type: none"> • The total volume of the units (UASB reactor, activated sludge reactor, secondary sedimentation tank and sludge dewatering) is lower than the total volume of the conventional activated sludge units (primary sedimentation tank, activated sludge reactor, secondary sedimentation tank, sludge thickener, sludge digester and sludge dewatering)
	Reduction in the consumption of chemical products for dewatering	<ul style="list-style-type: none"> • Reduction due to decreased sludge production and improved dewaterability
	Smaller number of different units to be installed	<ul style="list-style-type: none"> • There is no need for primary sedimentation tanks, thickeners and digesters, which are replaced by the UASB reactor
	Less equipment requirements	<ul style="list-style-type: none"> • The UASB reactor does not have electromechanical equipment, unlike the primary sedimentation tanks, thickeners and digesters of the conventional activated sludge systems

(Continued)

Table 30.2 (Continued)

Aspect	Item	Remark
	Greater operational simplicity	<ul style="list-style-type: none"> Compared with the traditional concept of the conventional activated sludge system, there are less units to be operated and less electromechanical equipment to be maintained
Disadvantage	Lower capacity for biological nutrient removal (N and P)	<ul style="list-style-type: none"> Nitrogen removal is only feasible if a minimum proportion between the concentration of nitrogenous matter (TKN) and the organic matter (COD) is reached Similarly, there is also a minimum P/COD ratio for phosphorus removal Once the UASB reactor removes a large portion of the organic carbon and hardly affects the nutrient concentration, in general the concentration of organic matter in the anaerobic effluent is smaller than the minimum necessary for good denitrification and phosphorus removal
Similarity	Similar efficiency to the traditional concept of conventional activated sludge	<ul style="list-style-type: none"> The efficiency of the system in the removal of the main pollutants (except for N and P) is similar to that of the conventional activated sludge system

The operational experience with the new systems being built with this configuration will allow continuous progress in the knowledge of design criteria and parameters to be used. In this book, the same parameters usually adopted for conventional activated sludge systems have been used, based on the understanding that the main physical and biochemical phenomena involved are the same. However, it is possible that some coefficients of the mathematical model of the process are different, but this should not affect the design stage substantially.

30.2.6 Comparison among the main variants of the activated sludge process

In this section, the main variants of the activated sludge process are compared. The main dividing factor among the variables is the sludge age, characterising the extended aeration and conventional activated sludge modes, as well as the existence of pre-treatment (e.g., UASB reactor).

The following tables are presented to allow a comparison among the systems: (a) Table 30.3 – shows the main characteristics (efficiencies, requirements, production) of the systems; and (b) Table 30.4 gives comparison between several operational characteristics of the conventional activated sludge, extended aeration and UASB reactor-activated sludge systems.

Table 30.3. Main characteristics of the activated sludge systems used for the treatment of domestic sewage

General item	Specific item	Type		
		Conventional	Extended aeration	UASB-activated sludge
Sludge age	Sludge age (day)	4–10	18–30	6–10
F/M ratio	F/M ratio (kgBOD/kgMLVSS·d)	0.25–0.50	0.07–0.15	0.25–0.40
Removal efficiency	BOD (%)	85–95	93–98	85–95
	COD (%)	85–90	90–95	83–90
	Suspended solids (%)	85–95	85–95	85–95
	Ammonia (%)	85–95	90–95	75–90
	Nitrogen (%) ⁽¹⁾	25–30	15–25	15–25
	Phosphorus (%) ⁽¹⁾	25–30	10–20	10–20
	Coliforms (%)	60–90	70–95	70–95
Area required	Area (m ² /inhabitant) ⁽²⁾	0.2–0.3	0.25–0.35	0.2–0.3
Total volume	Volume (m ³ /inhabitant) ⁽³⁾	0.10–0.12	0.10–0.12	0.10–0.12
Energy ⁽⁴⁾	Installed power (W/inhabitant)	2.5–4.5	3.5–5.5	1.8–3.5
	Energy consumption (kW·hour/inhabitant·year)	18–26	20–35	14–20
Volume of sludge ⁽⁵⁾	To be treated (L sludge/inhabitant·d)	3.5–8.0	3.5–5.5	0.5–1.0
	To be disposed of (L sludge/inhabitant·d)	0.10–0.25	0.10–0.25	0.05–0.15
Sludge mass	To be treated (gTS/inhabitant·d)	60–80	40–45	20–30
	To be disposed of (gTS/inhabitant·d)	30–45	40–45	20–30

Notes:

The values shown are typical, but may vary even outside the ranges depending on local circumstances. ⁽¹⁾: Larger efficiencies can be reached in the removal of N (especially in conventional activated sludge and in the extended aeration) and P (especially in conventional activated sludge) through specific stages (denitrification and phosphorus removal). The UASB-activated sludge method is not efficient in the biological removal of N and P.

⁽²⁾: Smaller areas can be obtained by using mechanical dewatering. The area values represent the area of the whole WWTP, not just of the treatment units.

⁽³⁾: The total volume of the units includes UASB reactors, primary sedimentation tanks, aeration tanks, secondary sedimentation tanks, gravity thickeners and primary and secondary digesters. The dewatering process assumed in the computation of the volumes is mechanical. The need for each of the units depends on the variant of the activated sludge process.

⁽⁴⁾: The installed power should be enough to supply the O₂ demand in peak loads. The energy consumption requires a certain control of the O₂ supply, to be reduced at times of lower demand.

⁽⁵⁾: The sludge volume is a function of the concentration of total solids (TS), which depends on the processes used in the treatment of the liquid phase and the solid phase. The upper range of per capita volumes of sludge to be disposed of is associated with dewatering by centrifuges and belt presses (lower concentrations of TS in the dewatered sludge), while the lower range is associated with drying beds or filter presses (larger TS concentrations).

Source: von Sperling (1997), Alem Sobrinho and Kato (1999) and von Sperling *et al.* (2001)

Table 30.4. Comparison among the main variants of the activated sludge systems for the treatment of domestic sewage

Item	Conventional activated sludge	Extended aeration	UASB – activated sludge
Sludge age	↓ 4 to 10 days	↑ 18 to 30 days	↓ 6 to 10 days
F/M ratio	↑ • 0.25 to 0.50 kgBOD/kgMLVSS-d	↓ • 0.07 to 0.15 kgBOD/kgMLVSS-d	↑ • 0.25 to 0.4 kgBOD/kgMLVSS-d
Primary sedimentation tank	• Present	• Absent	• Absent
UASB reactor	• Absent	• Absent	• Present
Soluble effluent BOD	↓ • Low • Can be practically ignored	↓ • Very low • Can be practically ignored	↓ • Low • Can be practically ignored
Particulate effluent BOD	↑ • Depends on the settleability of the sludge and the performance of the secondary sedimentation tank • As nitrification is expected to happen, if there is no denitrification in the reactor, it can occur in the secondary sedimentation tank, causing rising sludge and solids loss • Secondary sedimentation tank is subject to problems with filamentous bacteria and other processes that deteriorate the settleability	↑ • Depends on the settleability of the sludge and the performance of the secondary sedimentation tank • The larger load of influent solids in the secondary sedimentation tank requires unit sizes to be determined more conservatively • If there is no denitrification in the reactor, it can occur in the secondary sedimentation tank, causing rising sludge and solids loss • Secondary sedimentation tank is subject to problems with filamentous bacteria and other processes that deteriorate the settleability	↑ • Depends on the settleability of the sludge and the performance of the secondary sedimentation tank • As nitrification is expected to happen, if there is no denitrification in the reactor, it can occur in the secondary sedimentation tank, causing rising sludge and solids loss • Secondary sedimentation tank is subject to problems with filamentous bacteria and other processes that deteriorate the settleability

Nitrification	<ul style="list-style-type: none"> • Very probable but subject to the instability in the lower range of the sludge ages, especially at lower temperatures • Totally consistent in the upper range of sludge ages, unless there are specific environmental problems (e.g., toxicity, lack of DO) 	<ul style="list-style-type: none"> • Totally consistent in the upper range of sludge ages, unless there are specific environmental problems (e.g., toxicity, lack of DO) 	<ul style="list-style-type: none"> • Likely to occur, unless there are environmental problems (e.g., toxicity, lack of DO) • The toxicity to the nitrifying bacteria by effluent sulphide from the UASB reactor is a topic that deserves investigation
Volume of the aerobic reactor (aeration tank)	<ul style="list-style-type: none"> • Low (hydraulic detention times in the order of 6 to 8 hours) 	<ul style="list-style-type: none"> • High (hydraulic detention times in the order of 16 to 24 hours) 	<ul style="list-style-type: none"> • Very reduced due to the previous removal of a large part of the organic matter (hydraulic detention times in the order of 3 to 5 hours)
Area of the secondary sedimentation tanks	<ul style="list-style-type: none"> • Low 	<ul style="list-style-type: none"> • Higher, due to the large influent solids load and the settleability characteristics of the sludge 	<ul style="list-style-type: none"> • Lower, due to the smaller influent solids load
Oxygen requirements	<ul style="list-style-type: none"> • Reduced, due to the lower respiration by the biomass and to the previous BOD removal in the primary settling 	<ul style="list-style-type: none"> • High, due to the oxygen consumption for the respiration of the large amount of biomass present undergoing aerobic digestion and to the non-existence of primary settling 	<ul style="list-style-type: none"> • Lower, due to the lower respiration by the biomass and to the high BOD removal in UASB reactor
Energy requirements	<ul style="list-style-type: none"> • Low, due to the low oxygen consumption 	<ul style="list-style-type: none"> • High, due to the high oxygen consumption 	<ul style="list-style-type: none"> • Lower, due to the lower oxygen consumption
Sludge production	<ul style="list-style-type: none"> • High, even though it decreases after anaerobic digestion, becoming reasonable 	<ul style="list-style-type: none"> • Reasonable 	<ul style="list-style-type: none"> • Low, since the anaerobic reactor produces a thick sludge in small quantities, and the aerobic sludge undergoes digestion and thickening in the anaerobic reactor

(Continued)

Table 30.4 (Continued)

Item	Conventional activated sludge	Extended aeration	UASB – activated sludge
Sludge stabilisation in the reactor	<ul style="list-style-type: none"> • Lower and insufficient for the sludge to be directed to natural drying (generation of bad odours) 	<ul style="list-style-type: none"> • Sufficient and comparable to separate digestion processes, such as the anaerobic digesters 	<ul style="list-style-type: none"> • Sufficient and comparable to separate digestion processes, such as anaerobic digesters
Sludge thickening	<ul style="list-style-type: none"> • Necessary (mainly for the secondary sludge) 	<ul style="list-style-type: none"> • Can be used, but thickening by gravity is not effective. Mechanised thickening is advised 	<ul style="list-style-type: none"> • Normally unnecessary
Separate digestion of the primary sludge	<ul style="list-style-type: none"> • Necessary 	<ul style="list-style-type: none"> • No primary sludge 	<ul style="list-style-type: none"> • No primary sludge
Separate digestion of the aerobic sludge	<ul style="list-style-type: none"> • Necessary 	<ul style="list-style-type: none"> • Unnecessary 	<ul style="list-style-type: none"> • The aerobic sludge is returned to the UASB reactor, where it undergoes digestion
Dewaterability of the sludge	<ul style="list-style-type: none"> • Good dewaterability 	<ul style="list-style-type: none"> • Lower dewaterability 	<ul style="list-style-type: none"> • Excellent dewaterability
Stability of the process	<ul style="list-style-type: none"> • Larger susceptibility to toxic discharges than extended aeration 	<ul style="list-style-type: none"> • High 	<ul style="list-style-type: none"> • Satisfactory, as it is made up of two stages in series (one anaerobic and one aerobic)
Operational simplicity	<ul style="list-style-type: none"> • Low 	<ul style="list-style-type: none"> • Greater, due to the absence of primary sedimentation tanks and sludge digesters, and for being a more robust and stable system 	<ul style="list-style-type: none"> • Intermediate (larger complexity in the treatment of the liquid phase, but greater simplicity in the treatment of the solid phase)

Note: ↓ = low or reduced ⇕ = variable or intermediate ↑ = high or elevated
Source: von Sperling (1997) and von Sperling *et al.* (2001)

31

Principles of organic matter removal in continuous-flow activated sludge systems

31.1 PRELIMINARIES

The fundamentals of biological wastewater treatment were discussed in Chapter 9. In this chapter, the following items were discussed: influence of the solids recirculation, representation of the substrate and solids, solids production, hydraulic detention time, solids retention time, cell wash-out time, food/microorganism ratio, substrate utilisation rate and solids distribution in the wastewater treatment. All of these items are of fundamental importance for the activated sludge system and the reader must be familiar with them to understand the topics discussed below.

The present chapter covers the removal of the carbonaceous organic matter specifically in activated sludge systems and introduces new concepts that are applied to the system. The topics use the nomenclature adopted in Chapter 9 and shown again in Figure 31.1.

The intermediate level of simplicity adopted in Chapter 9 has been kept here. It is known that there are very good and widely accepted models for the activated sludge process (e.g., IWA models), but these are at a higher level of sophistication and require the adoption of many parameters and input values. For these reasons, a more conventional approach of the activated sludge modelling is adopted in this book.

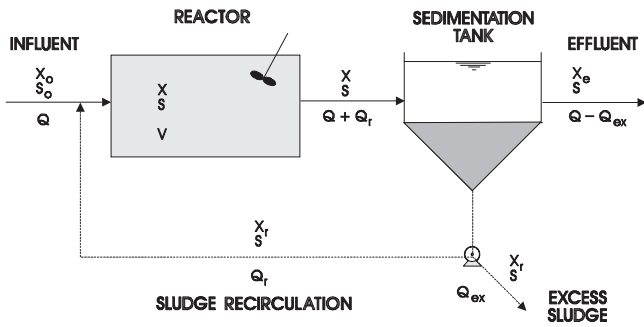

S_o	=	influent substrate concentration (total BOD) (mg/L or g/m ³)
S	=	effluent substrate concentration (soluble BOD) (mg/L or g/m ³)
Q	=	influent flow (m ³ /d)
Q_r	=	return sludge flow (m ³ /d)
Q_{ex}	=	excess sludge flow (m ³ /d)
X	=	mixed liquor suspended solids concentration (mg/L or g/m ³)
X_o	=	influent suspended solids concentration (mg/L or g/m ³)
X_r	=	return activated sludge suspended solids concentration (mg/L or g/m ³)
V	=	reactor volume (m ³)

Figure 31.1. Representation of the main variables in the activated sludge process

Two mass balances can be done, one for the substrate and the other for the biomass. These mass balances are essential for the sizing of the biological reactor and are detailed in the following sections.

X is the concentration of solids. In the reactor these solids are typically biological solids and are represented by the *biomass* (microorganisms) produced in the reactor at the expense of the utilised substrate. These solids are called **mixed liquor suspended solids (MLSS)**.

In contrast, in the influent to the reactor, the solids are those originally present in the wastewater and, in many references they are neglected in the general mass balance. When appropriate, for the sake of clarity, these solids from the influent are not considered in some calculations in this chapter. However, it will still be shown in this chapter that in some formulae these solids have an influence on the sludge production of the system.

The solids can be represented as total suspended solids (X) or volatile suspended solids (X_v). When representing the biomass in the reactor, it is preferable to use X_v , while when analysing the behaviour of the solids in the secondary sedimentation tank, X is used. X_v is also called **mixed liquor volatile suspended solids (MLVSS)**.

The value of X_r is greater than X , that is, the **return sludge** X_r has a higher concentration of suspended solids, which leads to the maintenance of high SS concentrations in the reactor. The solids recycling can be done by pumping the sludge from the bottom of the secondary sedimentation tank (in continuous-flow systems) or through other operational procedures of solids retention in the reactor (in intermittent-flow systems).

In Figure 31.1 there is still another flow line, which corresponds to the **excess sludge** (Q_{ex}). This comes from the fact that, for the system to be maintained in equilibrium, the quantity of biomass production (bacterial growth) must be compensated by an equivalent wastage of solids. If solids are not wasted from the system, their concentration progressively increases in the reactor and the solids are transferred to the secondary sedimentation tanks, up to a point when they become overloaded. In this situation, the settling tank is not capable of transferring solids to its bottom anymore and the level of the sludge blanket starts to rise. Above a certain level, the solids start to leave with the final effluent, deteriorating its quality. Thus, in simplified terms, it can be said that the daily solids production must be counterbalanced by a withdrawal of an equivalent quantity (mass per unit time). The excess sludge can be wasted from the return sludge line (as shown in Figure 31.1) or directly from the reactor.

31.2 SLUDGE AGE IN ACTIVATED SLUDGE SYSTEMS

As pointed out in Chapter 9, the sludge age is a fundamental parameter for the design and operation of the activated sludge process and is related to the reactor volume, production of solids, oxygen consumption and other operational variables of the process. Typical **sludge age** values in the activated sludge system are:

- *Conventional activated sludge*: $\theta_c = 4$ to 10 days
- *Extended aeration*: $\theta_c = 18$ to 30 days

The resultant **hydraulic detention time** in the reactor varies as follows:

- *Conventional activated sludge*: $t = 6$ to 8 hours (<0.3 days)
- *Extended aeration*: $t = 16$ to 24 hours (0.67 to 1.0 days)

The **F/M ratio** generally has the following values:

- *Conventional activated sludge*: $F/M = 0.3$ to 0.8 kgBOD₅/kgVSS·d
- *Extended aeration*: $F/M = 0.08$ to 0.15 kgBOD₅/kgVSS·d

These concepts were defined in Chapter 9.

31.3 SUSPENDED SOLIDS CONCENTRATION IN THE REACTOR

The design aspects related to the concept of X_v are examined in detail in this section.

To obtain the VSS concentration in the aeration tank, or MLVSS concentration in a system with solids recycling, Equation 9.42 can be rearranged to:

$$X_v = \frac{Y(S_o - S)}{1 + K_d \cdot f_b \cdot \theta_c} \left(\frac{\theta_c}{t} \right) \quad (31.1)$$

where:

θ_c = sludge age (d)

Y = yield coefficient (gVSS produced per gBOD removed) (g X_v /gBOD $_5$)

K_d = endogenous respiration coefficient (d $^{-1}$)

f_b = biodegradable fraction of MLVSS (X_b/X_v)

All of these parameters were explained in Chapter 9. Typical values of Y and K_d are:

$$\begin{aligned} Y &= 0.5 \text{ to } 0.7 \text{ g VSS/g BOD}_5 \text{ removed} \\ K_d &= 0.06 \text{ to } 0.10 \text{ gVSS/gVSS}\cdot\text{d} \end{aligned}$$

Equation 31.1 incorporates the concept of f_b . As seen in Chapter 9, f_b is given by:

$$f_b = \frac{f_{b'}}{1 + (1 - f_{b'}) \cdot K_d \cdot \theta_c} \quad (31.2)$$

where:

f_b = biodegradable fraction of the VSS generated in a system subjected to a sludge age θ_c (X_b/X_v)

$f_{b'}$ = biodegradable fraction of the VSS immediately after its generation in the system, that is, with $\theta_c = 0$. This value is typically equal to 0.8 (= 80%).

Equation 31.1 is important in the estimation of the VSS concentration in a particular system once the other parameters and variables are known or have been estimated. The analysis of this equation also provides interesting considerations about the influence of the sludge recirculation on the VSS concentration in the reactor.

It was seen in Chapter 9 that $\theta_c = t$ in a *system without recirculation*. Under these conditions, Equation 31.1 is reduced to:

$$X_v = \frac{Y \cdot (S_o - S)}{1 + K_d \cdot f_b \cdot t} \quad (31.3)$$

It can be seen that the difference between both equations is the factor (θ_c/t), which has a multiplying effect on Equation 31.3, in that it increases the suspended solids concentration in the reactor. As mentioned in Section 31.4, any increase in

X_v , in a particular design, will result in a proportional decrease in the necessary volume for the reactor.

Typical values of X_v in an activated sludge system are:

- conventional activated sludge = 1,500 to 3,500 mgVSS/L
- extended aeration = 2,500 to 4,000 mgVSS/L

The maximum design concentration of MLSS in the reactor is generally limited to 4,500–5,000 mg/L. Extended aeration systems tend to have a higher MLSS concentration than the conventional activated sludge systems. Naturally, the larger the concentration of MLSS (or MLVSS) in the reactor, the greater the availability of the biomass to assimilate the influent substrate, resulting in the need for smaller reactor volumes (for a given removal efficiency). Some practical aspects, however, impose the mentioned upper limits:

- MLSS concentrations above a certain limit require larger secondary sedimentation tanks. Large surface areas for these units would become necessary for high SS loads flowing into them, which could offset the economic gain obtained with the reduced reactor volume.
- The transfer of oxygen to the entire biomass is adversely affected in the case of very high MLSS values.

In Section 9.5.8, the methodology for determining the VSS/SS ratio in an activated sludge reactor as a function of the sludge age is described. In general terms, the ranges of average VSS/SS values are as follows:

- Conventional activated sludge: VSS/SS = 0.70 to 0.85
- Extended aeration: VSS/SS = 0.60 to 0.75

31.4 CALCULATION OF THE REACTOR VOLUME

In Equation 31.1, replacing t with V/Q , and making V explicit leads to:

$$V = \frac{Y \cdot \theta_c \cdot Q \cdot (S_o - S)}{X_v \cdot (1 + K_d \cdot f_b \cdot \theta_c)} \quad (31.4)$$

The volume of the reactor can be calculated by using this equation, provided that Q and S_o are known, a desired concentration for the soluble BOD effluent S is proposed, Y and K_d values are assumed, f_b is calculated and adequate values of the design parameters θ_c and X_v are adopted.

Equation 31.4 can be used for both the system with recirculation and the system without recirculation. In the latter case, when adopting $\theta_c = t$, the volume of the

reactor can be calculated directly using the formula $V = t \cdot Q$. However, the concentration of solids should be calculated using Equation 31.3.

Example 31.1

Calculate the volume of the reactor in the following systems:

- conventional activated sludge: $\theta_c = 6$ d; $X_v = 2,500$ mg/L
- extended aeration $\theta_c = 22$ d; $X_v = 3,000$ mg/L

General data:

- $Q = 1,500$ m³/d (design data)
- $S_o = 300$ mg/L (design data, assuming that no primary sedimentation tanks are available in both systems, for comparison purposes)
- $S = 5$ mg/L (soluble BOD; desired value)
- $Y = 0.7$ (assumed)
- $K_d = 0.09$ d⁻¹ (assumed)
- $f_b' = 0.8$ (adopted)

Solution:

(a) Conventional activated sludge

- Biodegradable fraction f_b (Equation 31.2)

$$f_b = \frac{f_b'}{1 + (1 - f_b') \cdot K_d \cdot \theta_c} = \frac{0.8}{1 + (1 - 0.8) \times 0.09 \times 6} = 0.72$$

- Volume of the reactor (Equation 31.4)

$$V = \frac{Y \cdot \theta_c \cdot Q \cdot (S_o - S)}{X_v \cdot (1 + K_d \cdot f_b \cdot \theta_c)} = \frac{0.7 \times 6 \times 1,500 \times (300 - 5)}{2,500 \times (1 + 0.09 \times 0.72 \times 6)} = 535 \text{ m}^3$$

- Hydraulic detention time

$$t = \frac{V}{Q} = \frac{535 \text{ m}^3}{1,500 \text{ m}^3/\text{d}} = 0.36 \text{ d} = 8.6 \text{ hours}$$

(b) Extended aeration

- Biodegradable fraction f_b (Equation 31.2)

$$f_b = \frac{f_b'}{1 + (1 - f_b') \cdot K_d \cdot \theta_c} = \frac{0.8}{1 + (1 - 0.8) \times 0.09 \times 22} = 0.57$$

- Volume of the reactor (Equation 31.4)

$$V = \frac{Y \cdot \theta_c \cdot Q \cdot (S_o - S)}{X_v \cdot (1 + K_d \cdot f_b \cdot \theta_c)} = \frac{0.7 \times 22 \times 1500 \times (300 - 5)}{3,000 \times (1 + 0.09 \times 0.57 \times 22)} = 1067 \text{ m}^3$$

Example 31.1 (Continued)

- Hydraulic detention time

$$t = \frac{V}{Q} = \frac{1,067 \text{ m}^3}{1,500 \text{ m}^3/\text{d}} = 0.71 \text{ d} = 17.1 \text{ hours}$$

It is observed that the extended aeration system requires larger reactor volumes compared to the conventional activated sludge system, due to the greater sludge age. However, the increase is not directly proportional to the relationship between the sludge ages.

An important aspect to be observed in Equation 31.4 is that *the calculation of the reactor volume is a function of the sludge age θ_c , and not of the hydraulic detention time t* . Because of this, t should not be used in the sizing of the reactor by means of the formula $V = t \cdot Q$, but only to evaluate the conditions of hydraulic stability and the resistance to shock loading. In case the system is without recirculation, naturally, the concept $\theta_c = t$ can be used.

The reason for using θ_c instead of t is as follows. A wastewater with a high flow, but a low BOD concentration, can require the same activated sludge reactor volume as a wastewater with a low flow but with a high BOD concentration, provided that the BOD loads are the same (load = flow \times concentration = $Q \cdot (S_o - S)$). However, once the same volumes are obtained, the hydraulic detention times will be essentially different, since the flow values differ from each other. Determining reactor volumes based only on the hydraulic detention time would, in this case, result in different values, which would induce under- or over-estimation, and in different treatment efficiencies. This is illustrated in Example 31.2.

Example 31.2

Calculate the reactor volume and the hydraulic detention time for an industrial wastewater in a conventional activated sludge system. Adopt the same parameters of Example 31.1 and compare the results with item “a” of the referred to example. The industrial wastewater data are:

- $Q = 300 \text{ m}^3/\text{d}$
- $S_o = 1,500 \text{ mg/L}$
- $S = 25 \text{ mg/L}$ (to keep the same removal efficiency as in Example 31.1)

Solution:

- Volume of the reactor (Equation 31.4)

$$V = \frac{Y \cdot \theta_c \cdot Q \cdot (S_o - S)}{X_v \cdot (1 + K_d \cdot \theta_c)} = \frac{0.7 \times 6 \times 300 \times (1500 - 25)}{2,500 \times (1 + 0.09 \times 0.72 \times 6)} = 535 \text{ m}^3$$

Example 31.2 (Continued)

- Hydraulic detention time

$$t = \frac{V}{Q} = \frac{535 \text{ m}^3}{300 \text{ m}^3/\text{d}} = 1.78 \text{ d} = 42.8 \text{ hours}$$

When compared with the domestic sewage in Example 31.1, the volume of the reactor is the same (535 m³), but the hydraulic detention time of Example 31.1 is five times lower (0.36 days). The reactor volumes are the same due to the fact that the BOD loads are the same (the industrial flow is five times smaller, but the concentration is five times larger). The detention times are different, since the industrial flow is five times smaller. For these reasons, it is important to size the system based on the sludge age instead of on the hydraulic detention time. For the calculation of the reactor volume, what ultimately matters is the BOD load, not the flow or the concentration itself.

31.5 SUBSTRATE REMOVAL

As expressed in Section 9.4, the bacterial growth rate, based on Monod's kinetics, is given by:

$$\frac{dX_v}{dt} = \mu_{\max} \cdot \left(\frac{S}{K_s + S} \right) \cdot X_v - K_d \cdot f_b \cdot X_v \quad (31.5)$$

where:

μ_{\max} = maximum specific growth rate (d⁻¹)

S = concentration of the limiting substrate (mg/L). In the case of treatment for BOD removal, the limiting nutrient is the organic matter itself

K_s = half-saturation constant, which is defined as the concentration of the substrate for which $\mu = \mu_{\max}/2$ (mg/L)

See Section 9.4 for the usual values of μ_{\max} and K_s for the activated sludge process.

Dividing left- and right-hand sides of Equation 31.5 by X_v , and knowing that $\theta_c = X_v/(dX_v/dt)$ (see Equation 9.34):

$$\frac{1}{\theta_c} = \mu_{\max} \cdot \left(\frac{S}{K_s + S} \right) - K_d \cdot f_b \quad (31.6)$$

Rearranging this equation to make S (effluent soluble BOD) explicit:

$$S = \frac{K_s \cdot [(1/\theta_c) + K_d \cdot f_b]}{\mu_{\max} - [(1/\theta_c) + K_d \cdot f_b]} \quad (31.7)$$

This is the general equation to estimate the effluent soluble BOD from a complete-mix reactor. Since in complete-mix reactors S is generally much smaller than K_s (see Section 9.4.3), in the denominator of Monod's equation, $(K_s + S)$ could be simply substituted by S . In these conditions, first-order kinetics would prevail. With such a replacement, Equation 31.7 can be presented in the following simplified way:

$$S = \frac{K_s}{\mu_{\max}} \cdot \left(\frac{1}{\theta_c} + K_d \cdot f_b \right) \quad (31.8)$$

An interesting aspect in Equations 31.7 and 31.8 is that, in a complete-mix system in the steady state, the effluent BOD concentration (S) is independent of the influent concentration S_0 (Arceivala, 1981). This is justified by the fact that K_s , K_d and μ_{\max} are constant and, therefore, S depends only on the sludge age θ_c . The larger the influent BOD load, the larger the production of biological solids and, consequently, the larger the biomass concentration X_v . Thus, the higher the substrate available, the greater the biomass availability for its assimilation. It should be emphasised that this consideration is applicable only to the steady state. In the dynamic state, any increase in the influent BOD load is not immediately followed by a corresponding increase in the biomass, since such an increase occurs slowly. Thus, until a new equilibrium is reached (if an equilibrium will ever be reached at all), the quality of the effluent in terms of BOD will deteriorate.

The value of S can also be obtained by rearranging Equation 31.4, used for the calculation of the volume of the reactor. When all of the terms are known, S can be made explicit. It should be noted that, for typically domestic sewage, S is usually low, especially in extended aeration systems. In these conditions, any deviation in the estimate of S can lead to significant relative errors. However, such errors are not expected to be substantial, since, ultimately, in a design the interest is mainly in the range of values of S , not in an exact estimate.

The minimum concentration of soluble substrate S that can be reached in a system is when the sludge age θ_c tends to be infinite. In these conditions, the term $1/\theta_c$ is equivalent to zero. By replacing $1/\theta_c$ with 0 in Equation 31.7, Equation 31.9 is obtained, defining the minimum reachable effluent soluble BOD (S_{\min}). In a treatment system, in case one needs to obtain a value that is lower than S_{\min} , this will not be possible with a single complete-mix reactor (Grady and Lim, 1980). S_{\min} is independent of the presence of recirculation and is just a function of the kinetic coefficients.

$$S_{\min} = \frac{K_s \cdot K_d \cdot f_b}{\mu_{\max} - K_d \cdot f_b} \quad (31.9)$$

As already noted, for predominantly *domestic sewage*, the soluble effluent BOD is essentially small and could even be considered negligible (compared to the influent BOD). The exception is for systems with very small sludge ages ($\theta_c < 4$ days), in which S can be representative.

Example 31.3

Calculate the soluble effluent BOD concentration from the systems described in Example 31.1:

- conventional activated sludge: $\theta_c = 6$ days
- extended aeration: $\theta_c = 22$ days

Adopt $\mu_{\max} = 2.0 \text{ d}^{-1}$ and $K_s = 60 \text{ mg/L}$.

Solution:**(a) Conventional activated sludge**

Using Equation 31.7:

$$S = \frac{K_s \cdot [(1/\theta_c) + K_d \cdot f_b]}{\mu_{\max} - [(1/\theta_c) + K_d \cdot f_b]} = \frac{60 \times [(1/6) + 0.09 \times 0.72]}{2.0 - [(1/6) + 0.09 \times 0.72]} = 7.9 \text{ mg/L}$$

Note: if the simplified formula for first-order kinetics had been used (Equation 31.8), a value of $S = 6.9 \text{ mg/L}$ would have been obtained.

(b) Extended aeration

Using Equation 31.7:

$$S = \frac{K_s \cdot [(1/\theta_c) + K_d \cdot f_b]}{\mu_{\max} - [(1/\theta_c) + K_d \cdot f_b]} = \frac{60 \times [(1/22) + 0.09 \times 0.57]}{2.0 - [(1/22) + 0.09 \times 0.57]} = 3.1 \text{ mg/L}$$

Note: if the simplified formula for first-order kinetics had been used (Equation 31.8), a value of $S = 2.9 \text{ mg/L}$ would have been obtained.

(c) Comments

- In both cases, the general and simplified formulae produce very similar values.
- The concentrations of soluble effluent BOD are low in both systems. In domestic sewage treatment by activated sludge, this is the most frequent situation.
- In the extended aeration system, due to the higher sludge age, the concentration of soluble effluent BOD is lower. It should be remembered that these values are for steady-state conditions, and that the conventional activated sludge system is more susceptible to variations in the influent load (which can cause the effluent to deteriorate during transients).
- It should also be noted that, in Example 31.1, it was estimated that the effluent BOD (S) would be equal to 5 mg/L in the two systems. In the present example, it is observed that there is a slight deviation from this estimate. The volume of the reactor can be recalculated with the new S values. Another option is to calculate the acceptable soluble BOD in the effluent, according to the desired total BOD_5 and SS values in the effluent

Example 31.3 (Continued)

(see Section 31.6). However, the difference between these two approaches in respect to the direct calculations of the volume is expected to be very small.

- The BOD values have been presented in this example with decimals only for the sake of clarity in the comparisons. In a real situation, there is no sensitivity in the BOD test to express its values with decimals.

31.6 SOLUBLE BOD AND TOTAL BOD IN THE EFFLUENT

All the calculations for the design of the reactor, or for the determination of the effluent BOD, were made by assuming that S was the effluent **soluble BOD**, that is to say, the biochemical oxygen demand caused by the organic matter dissolved in the liquid medium. This BOD could be considered the total effluent BOD from the system, if the final sedimentation tank were capable of removing 100% of the suspended solids flowing into it. However, it is worth remembering that the concentration of these solids that will reach the secondary sedimentation tank is in the order of 3,000 to 5,000 mg/L. Thus, it is expected that they will not be entirely removed, and that a residual fraction will leave with the final effluent. As these solids have a large fraction of organic matter (mainly represented by the biomass), they will still cause an oxygen demand when they reach the receiving body. This demand is named **suspended BOD** or **particulate BOD**. Thus, in the final effluent of an activated sludge plant, there are the following fractions:

$$\text{Total effluent BOD}_5 = \text{Soluble effluent BOD}_5 + \text{Particulate effluent BOD}_5 \quad (31.10)$$

The soluble BOD can be estimated using Equation 31.7 or 31.8. For the estimation of the particulate BOD, some considerations should be made. The solids that generate oxygen demand are only the biodegradable solids, since the inorganic and the inert solids are not an organic substrate that can be assimilated by the bacteria and generate oxygen consumption. By using Equation 31.2, and knowing the process parameters, one can determine the parameter f_b , that is, estimate which fraction of the VSS present in the plant effluent is biodegradable and will, therefore, represent the BOD of the suspended solids. Once this biodegradable fraction is known, the oxygen consumption required to stabilise this fraction can be estimated. For this, Equation 31.11, relative to the stabilisation of the cellular material represented by the formula $C_5H_7NO_2$, can be used:

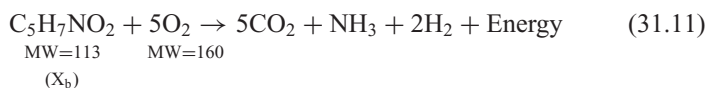

Thus, according to the stoichiometric relationship between the molecular weights (MW), 160 g of oxygen are required for the stabilisation of 113 g of biodegradable solids. Hence, this relationship is:

$$O_2/X_b = 160/113 = 1.42 \text{ gO}_2/\text{g biodegradable solids} \quad (31.12)$$

The ultimate biochemical oxygen demand (BOD_u) of the biodegradable solids is equal to this O_2 consumption. Thus, expressed in other terms:

$$BOD_u \text{ of the biodegradable solids} = 1.42 \text{ mgBOD}_u/\text{mgX}_b \quad (31.13)$$

In typical domestic sewage, the relationship between BOD_5 and BOD_u is approximately constant, and the ratio BOD_u/BOD_5 is usually adopted as 1.46. Thus, the ratio BOD_5/BOD_u is the same as the reciprocal of 1.46, that is, $BOD_5/BOD_u = 1/1.46 = 0.68 \text{ mgBOD}_5/\text{mgBOD}_u$. This means that when reaching the fifth day of the BOD test, 68% of the organic matter originally present has been stabilised, or else 68% of the total oxygen consumption takes place by the fifth day. Hence, Equation 31.13 can be expressed as:

$$\begin{aligned} BOD_5 \text{ of the SS}_{\text{biodeg}} &= 0.68 \text{ mgBOD}_5/\text{mgBOD}_u \times 1.42 \text{ mgBOD}_u/\text{mgX}_b \\ BOD_5 \text{ of the SS}_{\text{biodeg}} &\approx 1.0 \text{ mgBOD}_5/\text{mgX}_b \end{aligned} \quad (31.14)$$

To express this oxygen demand in terms of the volatile suspended solids, Equation 31.14 needs to be multiplied by $f_b (= X_b/X_v)$. The f_b values can be obtained using Equation 31.2. Hence:

$$\begin{aligned} BOD_5 \text{ of VSS} &\approx 1.0 (\text{mgBOD}_5/\text{mgX}_b) \times f_b (\text{mgX}_b/\text{mgVSS}) \\ BOD_5 \text{ of VSS} &\approx f_b (\text{mgBOD}_5/\text{mgVSS}) \end{aligned} \quad (31.15)$$

To make this equation more realistic and yet practical, it is interesting to express the effluent solids not as volatile suspended solids, but as total suspended solids. This is because, in the operational control routine and in the determination of the performance of the treatment system, the usual procedure is to measure the performance of the secondary sedimentation tank based on the effluent *total suspended solids* concentration. In Section 31.3, the values of the VSS/TSS ratio were presented, and in Section 9.5.8 it was shown how to calculate the value of the ratio. For conventional activated sludge systems, VSS/TSS varies from 0.70 to 0.85, while for extended aeration systems, VSS/TSS varies from 0.60 to 0.75. The BOD_5 of the total suspended solids will then be:

$$\boxed{BOD_5 \text{ of the effluent SS (mgBOD}_5/\text{mgSS)} = (\text{VSS/TSS}) \cdot f_b} \quad (31.16)$$

Based on the f_b values resulting from the application of Equation 31.2 and on the typical values of the relationship VSS/TSS described in the paragraph above, and

by applying Equation 31.16, the following ranges of typical values of **particulate BOD** are obtained:

- *conventional activated sludge: 0.45 to 0.65 mgBOD₅/mgTSS*
- *extended aeration: 0.25 to 0.50 mgBOD₅/mgTSS*

Experimental studies by von Sperling (1990) and Fróes (1996) with two extended aeration systems led to a ratio in the range of 0.21 to 0.24 mgBOD₅ for each mgSS, close to the lower limit of the theoretical range.

The determination of the BOD₅ of the final effluent is, therefore, essentially dependent on the estimation of the suspended solids concentration in the effluent from the secondary sedimentation tank. Unfortunately, there are no widely accepted rational approaches that can be safely used to estimate the effluent solids concentration, since the number of variables involved in the clarification function of secondary sedimentation tanks is very high. There are some empirical criteria that correlate the solids loading rate in the settling tank and other variables with the effluent SS concentration, but these relationships are very site specific.

Designers usually assume a SS concentration to be adopted in the design (equal to or lower than the SS discharge standard), and through this value the particulate BOD₅ is estimated. Based on a desired value of *total BOD₅* in the effluent, and with the estimated *particulate BOD₅*, by difference, the required *soluble BOD₅* is obtained (simple rearrangement of Equation 31.10). With this value the biological stage of the treatment plant can be properly designed.

Example 31.4 illustrates the complete calculation of the effluent total BOD₅ of an activated sludge system.

Example 31.4

For the conventional activated sludge system described in Example 31.1, calculate the concentrations of particulate, soluble and total BOD in the effluent. Assume that the design value for the effluent SS concentration is 30 mg/L.

Data already obtained in Examples 31.1 and 31.3:

$$S = 8 \text{ mg/L}$$

$$f_b = 0.72$$

Solution:

(a) Particulate BOD₅ in the effluent from the secondary sedimentation tank

Adopt the VSS/SS ratio equal to 0.8 (see above). The particulate BOD₅ is calculated using Equation 31.16:

$$\text{Particulate BOD}_5 = (\text{VSS/SS}) \cdot f_b = 0.8 \times 0.72 = 0.58 \text{ mgBOD}_5/\text{mgSS}$$

For 30 mg/L of effluent suspended solids, the effluent particulate BOD₅ is:

$$30 \text{ mgSS/L} \times 0.58 \text{ mgBOD}_5/\text{mgSS} = 17 \text{ mgBOD}_5/\text{L}$$

Example 31.4 (Continued)**(b) Summary of the effluent BOD₅ concentrations**

Soluble BOD = 8 mg/L (calculated in Example 31.3)

Particulate BOD = 17 mg/L

Total BOD = 8 + 17 = 25 mg/L

If, for example, a better effluent quality, with a total effluent BOD₅ of 20 mg/L were desired, there would be two possibilities. The first would be to reduce the effluent SS concentration (effluent polishing), to decrease the particulate BOD₅. The second would be to allow a maximum value for the soluble BOD₅ of 3 mg/L (= 20 – 17 mg/L). In this case, the reactor should be redesigned.

(c) Efficiency of the system in the BOD removal

The efficiency of the system in the BOD removal is given by:

$$E(\%) = \frac{\text{BOD}_5 \text{ influent} - \text{BOD}_5 \text{ effluent}}{\text{DBO}_5 \text{ influent}} \cdot 100$$

The biological removal efficiency (that considers only the soluble BOD in the effluent) is:

$$E = 100 \cdot (300 - 8) / 300 = 97\%$$

The overall removal efficiency (considering total BOD in the effluent) is:

$$E = 100 \cdot (300 - 25) = 92\%$$

In the calculation of the reactor volume and of the BOD removal, **S** is considered as the **soluble effluent BOD**, and **S₀** is the **total influent BOD**. This is because the organic suspended solids, which are responsible for the influent particulate BOD, are adsorbed onto the activated sludge flocs, and subsequently undergo successive transformations into simpler substrate forms, until they become available for synthesis. Only after this transformation to soluble organic solids will they be removed by similar mechanisms to those that acted on the soluble BOD. Thus, the influent particulate BOD will also generate bacterial growth and oxygen demand, but with a time lag compared to soluble BOD. In dynamic models this time lag should be taken into account, but it has no influence in steady-state models. This is the reason why **S₀** is considered as the total influent BOD.

Another aspect to be remembered is that, if the treatment system is provided with primary sedimentation tanks, such as the conventional activated sludge system, part of the influent BOD is removed by sedimentation, corresponding to the settled fraction of the volatile suspended solids. These will undergo subsequent separate digestion processes in the sludge treatment line and will not enter the reactor. The BOD₅ removal efficiency of primary sedimentation tanks usually ranges from 25%

to 35%, that is, to say, the influent BOD to the reactor (S_0) is 65% to 75% of the raw sewage BOD.

31.7 SLUDGE DIGESTION IN THE REACTOR

Besides the removal of carbonaceous and nitrogenous matter, an additional purpose of the biological stage can be the stabilisation of the sludge in the reactor. This is the case of the extended aeration systems, which do not have separate digestion for the excess sludge. The high sludge ages are responsible, therefore, not just for the oxidation of BOD and ammonia, but also for the aerobic digestion of the biomass. The digestion of the biodegradable fraction can be partial or practically total, depending on the sludge age adopted. In Example 9.10 of Section 9.5.8 (distribution of solids) it was seen that the extended aeration system in question had a high removal efficiency of the biodegradable biological solids generated in the system (93%), which resulted in an efficiency of 53% in the removal of the volatile solids. This efficiency is comparable to that obtained through separate digestion of the sludge.

Theoretically, for a certain biomass type, the sludge age that leads to the total destruction of the biodegradable solids formed can be determined. This value of θ_c can be obtained through the sequence shown below.

The *gross production of volatile solids* in the reactor is:

$$P_{X_v \text{ gross}} = Y \cdot Q \cdot (S_0 - S) \quad (31.17)$$

The *gross production of volatile biodegradable solids* is obtained by multiplying the above equation by the biodegradability fraction f_b . Therefore:

$$P_{X_b \text{ gross}} = f_b \cdot Y \cdot Q \cdot (S_0 - S) \quad (31.18)$$

On the other hand, the *destruction of the biodegradable solids* is given by:

$$P_{X_b \text{ destroyed}} = f_b \cdot Y \cdot Q \cdot (S_0 - S) \cdot [K_d \cdot \theta_c / (1 + f_b \cdot K_d \cdot \theta_c)] \quad (31.19)$$

To achieve complete destruction of all the biodegradable biological solids generated in the system, the production of solids should equal their destruction. Thus:

$$\begin{aligned} X_b \text{ production} &= X_b \text{ destruction} \\ f_b \cdot Y \cdot Q \cdot (S_0 - S) &= f_b \cdot Y \cdot Q \cdot (S_0 - S) \cdot [K_d \cdot \theta_c / (1 + f_b \cdot K_d \cdot \theta_c)] \end{aligned} \quad (31.20)$$

After making the necessary simplifications in Equation 31.20:

$$\theta_c = 1 / [K_d \cdot (1 - f_b)] \quad (31.21)$$

However, f_b is a function of θ_c . Using the formula

$$f_b = f_{b'} / [1 + (1 - f_{b'}) \cdot K_d \cdot \theta_c]$$

Table 31.1. Sludge age values (θ_c) to achieve total stabilisation of the biodegradable fraction of the generated suspended solids, as a function of the coefficient of endogenous respiration (K_d)

K_d (d^{-1})	0.05	0.07	0.09	0.11
θ_c (d)	45	32	25	20

(Equation 31.2), replacing f_b in Equation 31.21 and making rearrangements as required, the following equation is obtained:

$$\theta_c = \frac{1}{K_d \cdot \sqrt{1 - f_b'}} \quad (31.22)$$

For values of f_b' typically equal to 0.8, Equation 31.22 can still be rearranged into the following simplified form:

$$\theta_c = 2.24/K_d \quad (31.23)$$

Equations 31.22 and 31.23 allow the theoretical determination of the *limit* θ_c value, above which all the produced biodegradable biological solids are destroyed through aerobic digestion in the reactor. Thus, in the volatile suspended solids only the non-biodegradable fraction (inert, or endogenous) will remain, and in the total suspended solids, only the inorganic fraction (fixed) and the non-biodegradable fraction will remain. In these conditions, the excess sludge requires no additional separate digestion. The oxidation of the organic carbonaceous matter from the wastewater will continue, because the active solids are present in higher concentrations than the biodegradable solids.

For typical values of K_d , Table 31.1 shows the limit θ_c values for complete digestion in the reactor of the biodegradable biological solids formed, according to the simplified Equation 31.23.

As expected, the larger the coefficient of bacterial decay K_d , the lower the sludge age required for the complete stabilisation of the biodegradable solids.

The above calculations can be confirmed through Example 9.10, related to the solids distribution in the treatment. If a sludge age equal to the limit value is adopted, it can be seen that the destruction of the biodegradable solids will be the same as their production.

As an additional detail, the substrate utilisation rate (U) that leads to total stabilisation is given by:

$$U = K_d/Y \quad (31.24)$$

For sludge ages under the limit value, the digestion of the produced biodegradable solids is incomplete, although it can be, in practical terms, sufficient (in the sense that no additional separate digestion is required). On the other hand, for sludge ages above the limit value, total destruction is achieved (in fact, in the calculation, the destruction component becomes larger than the production one).

For a given sludge age, the *removal percentage of biodegradable solids* is given by Equation 31.25, while the *removal percentage of the volatile solids* is obtained using Equation 31.26. When analysing the efficiency of a sludge digestion process, the concept of percentage destruction of volatile solids is normally used. For comparison purposes, the typical efficiencies in the reduction of volatile solids in the anaerobic sludge digestion vary from 45 to 60%, and in the aerobic (separate) digestion, they vary from 40 to 50% (Metcalf and Eddy, 1991). The formulae shown below do not take into account the solids present in the influent wastewater to the reactor:

$$\% \text{ destruction of SS}_b = \left(\frac{K_d \cdot \theta_c}{1 + f_b \cdot K_d \cdot \theta_c} \right) \cdot 100 \quad (31.25)$$

$$\% \text{ destruction of VSS} = \left(\frac{f_b \cdot K_d \cdot \theta_c}{1 + f_b \cdot K_d \cdot \theta_c} \right) \cdot 100 \quad (31.26)$$

Tables 31.2 and 31.3 show the calculated values of the percentage removal of SS_b and VSS, respectively, for different values of θ_c and K_d .

Table 31.2. Percentage removal of the volatile biodegradable suspended solids formed in the reactor

θ_c (day)	Percentage removal of the produced biodegradable volatile SS (SS _b) (%)			
	$K_d = 0.05 \text{ d}^{-1}$	$K_d = 0.07 \text{ d}^{-1}$	$K_d = 0.09 \text{ d}^{-1}$	$K_d = 0.11 \text{ d}^{-1}$
4	17	23	28	33
8	31	40	48	55
12	42	53	63	72
16	52	65	76	86
20	60	75	87	99
24	68	84	98	—
28	75	92	—	—
32	81	100	—	—

Table 31.3. Percentage removal of the volatile suspended solids formed in the reactor

θ_c (day)	Percentage removal of the produced VSS (%)			
	$K_d = 0.05 \text{ d}^{-1}$	$K_d = 0.07 \text{ d}^{-1}$	$K_d = 0.09 \text{ d}^{-1}$	$K_d = 0.11 \text{ d}^{-1}$
4	13	18	21	24
8	23	29	33	37
12	30	37	42	46
16	36	42	47	51
20	40	47	51	55
24	44	50	55	—
28	47	53	—	—
32	49	55	—	—

31.8 RECIRCULATION OF THE ACTIVATED SLUDGE

To achieve a high concentration of solids in the reactor and a sludge age greater than the hydraulic detention time ($\theta_c > t$), it is necessary to recirculate or retain the sludge in the system. The sludge *retention* processes can be adopted in systems with intermittent operation, such as batch systems. The sludge *recirculation* through pumping is the most commonly used and is typical of the continuous-flow conventional activated sludge and extended aeration processes.

The amount of sludge to be recirculated will depend fundamentally on the quality of the sludge settled in the secondary sedimentation tank: the more concentrated the sludge, the lower the recirculation flow needs to be to reach a certain solids concentration in the reactor. In other words, good sludge settleability and thickening properties in the secondary sedimentation tank, resulting in a return sludge with higher SS concentration, will lead to a reduction in the recirculation flow. However, this analysis is complex, since the flow at the bottom of the secondary sedimentation tank (usually equal to the return sludge flow plus the excess sludge flow) in itself affects the concentration of the settled sludge. The SS concentration in the return sludge is called **RASS (return activated sludge suspended solids, also expressed as X_r)**.

Figure 31.2 shows the items that integrate the solids mass balance in the biological stage of the activated sludge system.

The **return sludge ratio R** is defined as:

$$R = Q_r/Q \quad (31.27)$$

The mass balance in a complete-mix reactor operating in the steady state leads to:

$$\text{Accumulation} = \text{Input} - \text{Output} + \text{Production} - \text{Consumption}$$

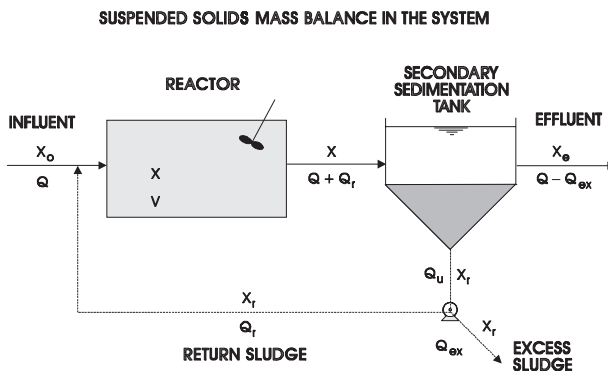

Figure 31.2. Suspended solids mass balance in the activated sludge system

In this mass balance, the following specific items are applicable:

- accumulation = 0 (there are no mass accumulations in the steady state)
- production = consumption (bacterial growth equals the removal of excess sludge in the steady state)
- input = raw sewage SS load + return sludge SS load
- output = MLSS load

The SS load in the raw sewage ($Q \cdot X_0$) is small, compared with the return sludge load ($Q_r \cdot X_r$). Neglecting the SS load in the raw sewage, one arrives at the following mass balance in the reactor:

$$\begin{aligned} \text{Input} &= \text{Output} \\ Q_r \cdot X_r &= (Q + Q_r) \cdot X \end{aligned} \quad (31.28)$$

After rearrangement of Equation 31.28:

$$R = \frac{Q_r}{Q} = \frac{X}{X_r - X} \quad (31.29)$$

By rearranging Equation 31.29, the formula that expresses X_r as a function of X and R , in the steady state, can be obtained:

$$X_r = X \cdot \frac{(R + 1)}{R} \quad (31.30)$$

If the mass balance had been made in the secondary sedimentation tank, the results obtained would be the same:

$$\begin{aligned} \text{Input} &= \text{Output} \\ (Q + Q_r) \cdot X &= Q_r \cdot X_r \end{aligned} \quad (31.31)$$

Equation 31.29 assumes that there are no biochemical mass production and consumption processes in the settling tanks, that the amount of solids leaving the settling tank through the final effluent (supernatant) is negligible and that $Q_r \approx Q_u$ (that is, the flow Q_{ex} is negligible compared to Q_r). Equation 31.31 is identical to Equation 31.28 and the values of R (Equation 31.29) and X_r (Equation 31.30) can be deduced from it.

Example 31.5

Calculate the required *return sludge ratio* to maintain a SS concentration in the reactor of Example 31.1 equal to 3,125 mg/L, knowing that the return sludge has an average SS concentration of 10,000 mg/L, as determined from measurements. Also calculate the *return sludge flow*, considering that the influent flow is 1,500 m³/d.

Example 31.5 (Continued)**Solution:**

Using Equation 31.29:

$$R = \frac{X}{X_r - X} = \frac{3,125}{10,000 - 3,125} = 0.45$$

If the return sludge ratio is known, Q_r can be calculated through the rearrangement of Equation 31.27:

$$Q_r = R \cdot Q = 0.45 \times 1,500 \text{ m}^3/\text{d} = 675 \text{ m}^3/\text{d}$$

The reason for using SS instead of VSS in the example is that most frequently in the operational routine of the treatment plant the solids concentrations are determined as SS, for simplicity reasons. However, in the calculations that involve biological stages (reactor), it is interesting to consider VSS, for the sake of uniformity and greater coherence. In this example, the SS concentration of 3,125 mg/L in the reactor corresponds to a VSS of 2,500 mg/L (VSS/SS ratio of 0.8).

The concentration of suspended solids in the return sludge (RASS) depends on the settling and thickening characteristics of the sludge, the MLSS concentration and the underflow from the settling tank. Typical average values of RASS are around:

SS in the return sludge (RASS): 8,000 to 12,000 mg/L

RASS can vary significantly along the day, outside the range given above, as a result of variations in the influent solids load to the settling tank.

The factors influencing the sludge quality are related to several design and operational parameters. Some important aspects are discussed here (Arceivala, 1981; Eckenfelder, 1980; Ramalho, 1977) and further examined in Chapters 39 and 41:

- Very low sludge ages can imply a bacterial growth with a tendency to be dispersed, instead of a flocculent growth.
- Very high sludge ages may result in a floc predominantly consisting of a highly mineralised residue of endogenous respiration, with a small flocculation capacity.
- Certain environmental conditions in the reactor such as low DO levels may lead to the predominance of filamentous microorganisms, which have a relatively high surface area per unit volume. These microorganisms, however, generate a poorly settling floc, giving rise to the so-called sludge bulking.
- A plug-flow reactor is capable of producing a sludge with a better settleability (predominance of the floc-forming bacteria over the filamentous ones) than a complete-mix reactor.

Usually, when maintaining the sludge age within the usual design ranges, the aeration is enough, and certain constituents of the raw sewage are within the acceptable limits, the sludge is expected to flocculate well and exhibit good settleability and compactness in the secondary sedimentation tank. As a result, the recirculation ratio can be lower. In Chapter 10, it was mentioned that the settling characteristics can be expressed through parameters such as the sludge volume index (SVI) and the interface settling velocity.

A recirculation ratio around 0.5 is adopted in systems operating in temperate climates, in which good compaction of the sludge in the secondary sedimentation tank is aimed at. In warm-climate regions, however, the tendency is to use higher values of R . One reason is that in these regions nitrification is very likely to occur in the reactor, due to the high temperatures. Additionally, it is also probable that denitrification will occur in the secondary sedimentation tank. The denitrification corresponds to the transformation of the nitrate into gaseous nitrogen. The N_2 bubbles are released by the bottom sludge and, in their upward movement, they adhere to the sludge flocs, transporting them to the surface (*rising sludge*). The consequence is an increased solids concentration in the final effluent, which leads to its deterioration in terms of SS and particulate BOD. To avoid this effect, the sludge recirculation should be faster to minimise denitrification in the secondary settler and its effects (Marais and Ekama, 1976). As the sludge is more quickly recirculated and becomes less liable to thickening, the solids concentration in the underflow sludge is lower, which implies the need for a higher recirculation rate. Figure 31.3 schematically illustrates the influence of the return sludge flow (or more precisely the underflow Q_u) on the RASS concentration, on the level of the sludge blanket and on the sludge detention time in the secondary sedimentation tank.

Typical values adopted in the operational routine of treatment plants operating in warm-climate regions are:

Return sludge ratio: $R = 0.7$ to 1.2

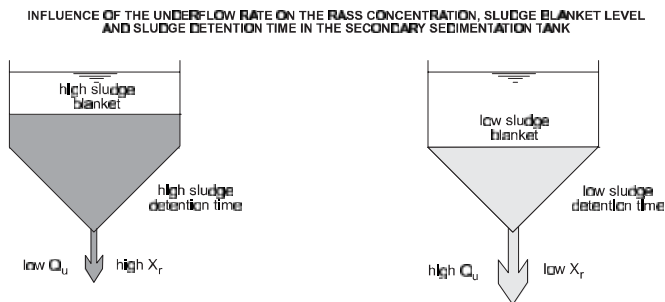

Figure 31.3. Influence of Q_u on the SS concentration in the return sludge, the sludge blanket level and the sludge detention time in the secondary sedimentation tank

However, the design should foresee a pumping capacity of around $R = 1.5$, for situations in which it becomes necessary to increase Q_r .

The increase in the capacity of an existing treatment plant can be obtained through an increase in the recirculation capacity, instead of expanding the reactor volume. This is true especially for systems having a low VSS concentration in the reactor. Through an increase in the value of R (and/or decrease in the excess sludge flow), an increase in VSS can be obtained, up to the practical limits discussed above (provided that the oxygenation capacity is enough for the new higher value of biomass respiration). The new value of R cannot be determined directly from Equation 31.29, using the new value of X . This is due to the fact that an increase in R may lead to a decrease in X_r .

It should be very clear that the existence of the sludge recirculation affects only the sludge age, with the hydraulic detention time remaining unaffected. The mass balance of the liquid remains constant (input = output), unlike the sludge, which is retained in the system. In a system with a return sludge ratio of $R = 1$ ($Q = Q_r$) each molecule of water has on average, probabilistically, the chance of passing twice through the reactor (an initial passage and another with the recirculation). As the influent flow is doubled ($Q + Q_r = 2Q$), the detention time in each passage is reduced to half ($t/2$). However, in the overall balance, after the two passages, the total time will be the same as t , therefore independent of the recirculation ratio.

Another aspect that should be very clear is the interaction between the return sludge flow Q_r , the excess sludge flow Q_{ex} and the sludge age. The flows Q_r and Q_{ex} are intimately connected, since both compose the underflow from the secondary sedimentation tank (Q_u). Thus:

$$Q_u = Q_r + Q_{ex} \quad (31.32)$$

Irrespective of how the excess sludge is removed (directly from the reactor or from the return sludge line), the net contribution of the recirculated sludge will always be equal to $Q_r = Q_u - Q_{ex}$. Two situations can happen:

- **Fixed underflow Q_u .** In these conditions, increasing Q_r automatically decreases Q_{ex} (see Equation 31.32). When reducing Q_{ex} , the system's sludge age increases, since the amount of sludge removed from the system is reduced (decrease in the denominator of Equation 9.33).
- **Increase of the underflow Q_u .** When increasing Q_r and maintaining Q_{ex} fixed, the underflow Q_u increases. However, the total mass of solids in the system remains the same, since the removal of solids from the system was not changed (fixed Q_{ex}). There is only a larger transfer of solids from the secondary sedimentation tank to the reactor, due to the increase in Q_r . Thus, the solids mass in the reactor increases, but the mass in the system (reactor+secondary sedimentation tank) remains the same. If the sludge age is computed in terms of only the *solids mass in the reactor*, there will be an apparent increase in the sludge age (increase in the numerator of Equation 9.33). On the other hand, if the sludge age is computed in

terms of the *solids mass in the system (reactor + secondary sedimentation tank)*, there will be no change in it (the numerator and the denominator in Equation 9.33 remain unaffected).

In a simplified manner, the roles of Q_r and Q_{ex} in the activated sludge system can be understood as follows (Takase and Miura, 1985):

- The **return sludge flow** Q_r affects the *balance* of solids between the reactor and the secondary sedimentation tank.
- The **excess sludge flow** Q_{ex} affects the *total* mass of solids in the system (reactor+secondary sedimentation tank).

It is important to understand that the design and the operation of activated sludge systems require an integrated view of the reactor and the secondary sedimentation tank. The biological stage depends strongly on the solid–liquid removal stage. Therefore, it is fundamental to understand the settling and thickening phenomena described in Chapter 10.

31.9 PRODUCTION AND REMOVAL OF EXCESS SLUDGE

31.9.1 Sludge production

(a) Production of biological solids

As thoroughly discussed, an amount of sludge equivalent to the VSS produced daily, corresponding to the reproduction of the cells that feed on the substrate, should be removed from the system, so that it remains in balance (production of solids = removal of solids). A small part of this sludge leaves the system with the effluent (supernatant) of the secondary sedimentation tank, but most of it is extracted through the excess sludge (Q_{ex}). The excess sludge should be directed to the sludge treatment and final disposal stages.

The net production of **biological solids** P_{xv} (expressed in terms of VSS) was analysed in detail in Chapter 9. An alternative way to present the net production is through the rearrangement of Equation 9.79 (net production of VSS) and Equation 31.4 (calculation of the reactor volume). Thus, P_{xv} can be expressed as:

$$P_{xv} \text{ net} = \text{Gross production of } X_v - \text{Destruction of } X_b$$

$$P_{xv} = Y \cdot Q \cdot (S_o - S) - K_d \cdot f_b \cdot X_v \cdot V \quad (31.33)$$

The same value can be arrived at using the concept of the *observed yield coefficient* (Y_{obs}), which directly reflects the net production of the sludge. Y_{obs} and P_{xv} can be obtained using Equations 9.81 and 9.82:

$$Y_{obs} = \frac{Y}{1 + f_b \cdot K_d \cdot \theta_c} \quad (31.34)$$

$$P_{xv} = Y_{obs} \cdot Q \cdot (S_o - S) \quad (31.35)$$

To obtain the production of biological solids in terms of TSS (P_x), P_{xv} should be divided by the VSS/TSS ratio. Typical values of this ratio were presented in Section 9.5.8, together with a methodology for its determination (not considering the solids present in the influent sewage).

Example 31.6

For the conventional activated sludge system described in Example 31.1, calculate the production of biological solids. Data from Examples 31.1, 31.3 and 31.4 include:

$$\begin{array}{lll} Q = 1,500 \text{ m}^3/\text{d} & \theta_c = 6 \text{ days} & Y = 0.7 \\ S_o = 300 \text{ mg/L} & X_v = 2,500 \text{ mg/L} & K_d = 0.09 \text{ d}^{-1} \\ S = 8 \text{ mg/L} & V = 535 \text{ m}^3 & f_b = 0.72 \\ & & \text{VSS/SS} = 0.80 \end{array}$$

Do not consider the solids in the raw sewage.

Solution:

(a) Calculation of the BOD load removed (information required in Example 31.7)

$$\begin{aligned} S_r &= Q \cdot (S_o - S) = 1,500 \text{ m}^3/\text{d} \times (300 - 8) \text{ g/m}^3 \times 10^{-3} \text{ kg/g} \\ &= 438 \text{ kgBOD/d} \end{aligned}$$

(b) Calculation of the biological solids production according to Equation 31.33

$$\begin{aligned} P_{xv} &= Y \cdot Q \cdot (S_o - S) - K_d \cdot f_b \cdot X_v \cdot V \\ P_{xv} &= 0.7 \times 1,500 \text{ m}^3/\text{d} \times (300 - 8) \text{ g/m}^3 \times 10^{-3} \text{ kg/g} \\ &\quad - 0.09 \text{ d}^{-1} \times 0.72 \times 2,500 \text{ g/m}^3 \times 535 \text{ m}^3 \times 10^{-3} \text{ kg/g} \\ P_{xv} &= 307 - 87 = 220 \text{ kgVSS/d} \end{aligned}$$

In terms of TSS, the production is:

$$P_x = P_{xv}/(\text{VSS/SS}) = (220 \text{ kg/d})/(0.8) = 275 \text{ kgSS/d}$$

(c) Calculation of the biological solids production according to Equations 31.34 and 31.35

$$Y_{\text{obs}} = \frac{Y}{1 + f_b \cdot K_d \cdot \theta_c} = \frac{0.7}{1 + 0.72 \times 0.09 \text{ d}^{-1} \times 6 \text{ d}} = 0.50$$

$$\begin{aligned} P_{xv} &= Y_{\text{obs}} \cdot Q \cdot (S_o - S) = 0.50 \times 1,500 \text{ m}^3/\text{d} \times (300 - 8) \text{ g/m}^3 \times 10^{-3} \text{ kg/g} \\ &= 220 \text{ kgVSS/d} \end{aligned}$$

Example 31.6 (Continued)

In terms of TSS, the production is:

$$P_x = P_{xv}/(VSS/SS) = (220 \text{ kg/d})/(0.8) = 275 \text{ kgSS/d}$$

It is observed, therefore, that the values of P_{xv} and P_x obtained using Equations 31.33 and 31.35 are identical. In Example 9.10, concerning the calculation of the distribution of the solids in the treatment, the daily production of VSS could have been obtained through the direct use of the simplified formula of Y_{obs} .

(b) Production of excess sludge

The *solids present in the raw sewage* (inorganic solids and non-biodegradable solids) also contribute to the production of excess sludge. The methodology for calculating the VSS/SS ratio and the production of secondary sludge including these solids is described in the general example in Chapter 34. If an initial approximation is desired, the values of Table 31.4 can be used, which were calculated for predominantly domestic sewage using the model described in this chapter, as well as the methodology exemplified in Section 31.13.

Table 31.4 includes the following alternatives of whether or not to consider the solids in the raw sewage and the presence of primary sedimentation tanks (in which approximately 60% of the suspended solids and 30% of BOD are removed):

- disregard the solids in the raw sewage (as is the case in most designs, but which leads to some distortions)
- consider the solids in the raw sewage in a system with primary sedimentation tanks
- consider the solids in the raw sewage in a system without primary sedimentation tanks

In Table 31.4, different combinations of the coefficients Y and K_d are presented (a high Y with a low K_d and vice versa). The VSS/SS ratio is relatively independent of the coefficients Y and K_d (in the range shown in the table) and is shown in Table 31.4 only as single intermediate values. The production of excess secondary sludge is more sensitive and is described according to three possible coefficient combinations (the first pair $Y - K_d$ results in the smallest sludge production, opposed to the last pair, in which the sludge production is the highest).

The utilisation of Table 31.4 is exemplified below. A conventional activated sludge plant that receives domestic sewage containing suspended solids, that includes a primary sedimentation tank and that has been designed for a sludge age of, say, 6 days, is expected to have a VSS/SS ratio of 0.76 and a sludge production between 0.75 to 0.95 kgSS/kgBOD₅ removed (depending on the coefficients Y and K_d adopted). An extended aeration plant that also contains solids in the influent, but does not include a primary sedimentation tank, and that has been designed for a sludge age of 26 days, is expected to have a VSS/SS of 0.68 and a sludge production between 0.88 and 1.01 kgSS/kgBOD₅ removed. Of course, in the design of the

Table 31.4. VSS/SS ratio in the reactor and production of excess secondary sludge per unit of BOD₅ removed from the reactor (kgSS/kgBOD₅ removed), as a function of the presence of solids in the influent, the existence of primary sedimentation tanks, the coefficients Y and K_d and the sludge age

Ratio	SS in the influent	Primary settling tank	Coefficients		Sludge age (day)									
			Y (g/g)	K _d (d ⁻¹)	2	6	10	14	18	22	26	30		
VSS/SS (g/g)	No	No	0.5-0.7	0.07-0.09	0.89	0.87	0.85	0.84	0.83	0.82	0.81	0.81		
	Yes	Yes	0.5-0.7	0.07-0.09	0.79	0.76	0.75	0.73	0.72	0.71	0.71	0.71		
	Yes	No	0.5-0.7	0.07-0.09	0.75	0.73	0.71	0.70	0.69	0.69	0.68	0.68		
	No	No	0.5	0.09	0.50	0.42	0.37	0.33	0.31	0.29	0.28	0.28		
SS/S _r (kgSS / kgBOD ₅ rem)	Yes	Yes	0.6	0.08	0.60	0.51	0.45	0.41	0.38	0.36	0.34	0.34		
	Yes	No	0.7	0.07	0.71	0.61	0.55	0.50	0.47	0.44	0.42	0.40		
	Yes	Yes	0.5	0.09	0.83	0.75	0.70	0.67	0.65	0.63	0.63	0.63		
	Yes	No	0.6	0.08	0.96	0.87	0.81	0.78	0.75	0.73	0.71	0.71		
	Yes	No	0.7	0.07	1.04	0.95	0.88	0.84	0.80	0.78	0.76	0.74		
	Yes	No	0.5	0.09	1.08	1.00	0.95	0.92	0.90	0.88	0.88	0.88		
	Yes	No	0.6	0.08	1.23	1.14	1.09	1.05	1.02	1.00	0.98	0.98		
	Yes	No	0.7	0.07	1.29	1.20	1.13	1.08	1.06	1.03	1.01	0.99		

Highlighted values: More usual values in activated sludge plants with typical flowsheets

- Per capita contributions: BOD = 50 g/inhabitant-day; SS = 60 g/inhabitant-day
- Removal efficiencies in the primary settling tank: BOD = 30%; SS = 60%

sludge treatment for the conventional activated sludge plant, the production of primary sludge also needs to be taken into account.

Example 9.10 (Section 9.5.8) showed the calculation sequence to estimate the production of *solids without considering the solids in the raw sewage*. In this example, for a removed BOD₅ load of 100 kgBOD₅/d, a production of 43.2 kgVSS/d was estimated in the system with a sludge age of 6 days. Therefore, the calculated relation was $43.2/100 = 0.43$ kgVSS/kgBOD₅ removed. The VSS/SS ratio calculated in the example was 0.87. Thus, the specific production of SS can be expressed as $0.43/0.87 = 0.49$ kgSS/kgBOD₅ removed. This value is within the range expressed in Table 31.4 for systems without consideration of SS in the influent, without primary settling tanks and with a sludge age of 6 days (range from 0.42 to 0.61 kgSS/kgBOD₅ – the variation is due to the different values adopted for Y and K_d). The calculated VSS/SS value of 0.87 is identical to the value shown in Table 31.4.

Table 31.4 shows how important it is to consider the influent solids when calculating the production of excess secondary sludge. The sludge production values shown are quite similar to those in the German practice, related by Orhon and Artan (1994). According to this reference, conventional activated sludge systems, with an influent to the reactor with a SS/BOD₅ ratio of 0.7 (typical of systems with primary sedimentation tanks), have a sludge production in the range of 0.82 to 0.92 kgSS/kgBOD₅ applied (for sludge ages varying from 10 to 4 days, respectively). Extended aeration systems, with an influent to the reactor with a SS/BOD₅ ratio of 1.2 (typical of systems without primary settling tanks), result in a sludge production of around 1.00 kgSS/kgBOD₅ applied (sludge age of 25 days).

Example 31.11 included in Section 31.13 further illustrates how to use Table 31.4 for estimating the solids production in an activated sludge system taking into account the solids in the influent sewage.

31.9.2 Removal of the excess sludge

(a) Without consideration of the influent solids

In activated sludge systems, the excess sludge can be removed from two different locations: **reactor** or **return sludge line**. *If the solids in the influent are neglected* (unrealistic assumption for domestic sewage, but frequently adopted in the literature), the excess sludge concentration and flow, which vary with the removal place, can be determined as follows:

- **Withdrawal of the excess sludge directly from the reactor (or from the reactor effluent).** This option is called *hydraulic control* of the system. The concentration of excess sludge is the same as the concentration of SS in the reactor (MLSS). If one wants to maintain the sludge age constant, the flow Q_{ex} can be obtained by:

$$Q_{ex}' = \frac{V}{\theta_c} \quad (31.36)$$

$$\text{SS concentration} = \text{MLSS} (=X) \quad (31.37)$$

where:

Q_{ex}' = excess sludge flow removed from the reactor (m^3/d)

V = reactor volume (m^3)

θ_c = sludge age (d)

X = MLSS concentration (mg/L)

- **Withdrawal of the excess sludge from the return sludge line.** The concentration of excess sludge is the same as the concentration of SS in the return sludge (RASS). If one wants to maintain the sludge age constant, the flow Q_{ex} can be obtained by:

$$Q_{ex}'' = \frac{V}{\theta_c} \cdot \frac{X}{X_r} \quad (31.38)$$

$$\text{SS concentration} = \text{RASS} (= X_r) \quad (31.39)$$

where:

Q_{ex}'' = excess sludge flow removed from the return sludge line (m^3/d)

X_r = RASS concentration (mg/L)

The removal of excess sludge from the return sludge line requires a flow Q_{ex} smaller than that required in the hydraulic control (X_r/X times smaller). Thus, the sludge *flow* to be treated is smaller, but the *load* of solids, which is equal to the product of concentration and flow, is the same. On the other hand, the hydraulic control is simpler, not requiring the determination of the SS concentration in the reactor and in the return line. In the hydraulic control, if one wants to maintain a sludge age of, for example, 20 days, it will suffice to remove 1/20 of the volume of the reactor per day as excess sludge.

(b) Considering the influent solids

It should be remembered that the methods shown in item (a) above do not take into account the influence of the solids in the influent wastewater (particularly the inert solids), and compute only the production and removal of the *biological solids produced in the system*. If the influent solids are considered, the calculations should be based on the total excess sludge production (P_x), as discussed in Section 31.9.1.b:

- **Withdrawal of the excess sludge directly from the reactor (or from the reactor effluent)**

$$Q_{ex}' = \frac{P_x \cdot 1,000}{X} \quad (31.40)$$

$$\text{SS concentration} = \text{MLSS} (= X) \quad (31.41)$$

where:

P_x = excess sludge production (kgSS/d)

Table 31.5. Items to be considered in the removal of the excess sludge from the activated sludge system

Process	Item
<i>Conventional activated sludge</i>	<ul style="list-style-type: none"> • The secondary excess sludge requires subsequent stabilisation, which is completed in the sludge treatment stage • The sludge can be removed directly from the reactor (smaller concentration of SS, larger Q_{ex}) or from the return sludge line (larger concentration of SS, smaller Q_{ex}) • The excess sludge can be removed continuously or intermittently • The excess sludge can be directed separately to the sludge treatment stage (including digestion) or returned to the primary settling tank, for sedimentation and treatment together with the primary sludge (smaller plants)
<i>Extended aeration</i>	<ul style="list-style-type: none"> • The secondary sludge is already largely stabilised and does not require a subsequent digestion stage • The sludge can be removed directly from the reactor or from the return sludge line • The sludge can be removed continuously or intermittently • The excess sludge is usually sent directly to the sludge-processing phase.

- **Withdrawal of the excess sludge from the return sludge line**

$$Q_{ex}'' = \frac{P_x \cdot 1,000}{X_r} \quad (31.42)$$

$$\text{SS concentration} = \text{RASS}(= X_r) \quad (31.43)$$

In the estimation of the excess sludge load to be removed, the *suspended solids load in the final effluent* can be discounted from the total value. The loss of solids in the final effluent is unintentional, but, in practice, it does occur. However, in most situations, this term is small, compared to the overall solids production.

A summary of additional aspects related to the removal of excess sludge is listed in Table 31.5.

Example 31.7

For the activated sludge system described in Example 31.6, determine the amount of excess sludge to be removed daily. Analyse the alternative methods of (a) removing the sludge directly from the reactor and (b) removing the sludge from the return sludge line. Make the calculations under two conditions: (i) without consideration of solids in the influent and effluent and (ii) with consideration of solids in the influent and in the effluent.

Example 31.7 (Continued)

Data from previous examples:

$$\begin{aligned} Q &= 1,500 \text{ m}^3/\text{d} & X &= 3,125 \text{ mg/L (MLSS)} \\ V &= 535 \text{ m}^3 & X_r &= 10,000 \text{ mg/L (RASS)} \\ \theta_c &= 6 \text{ days} & X_e &= 30 \text{ mg/L (suspended solids concentration} \\ & & & \text{in the final effluent)} \end{aligned}$$

Solution:

Without consideration of solids in the influent and effluent:

(a) Removal of the excess sludge directly from the reactor (hydraulic control)

- Daily flow to be wasted (Equation 31.36):

$$Q_{\text{ex}} = \frac{V}{\theta_c} = \frac{535 \text{ m}^3}{6 \text{ d}} = 89 \text{ m}^3/\text{d}$$

- SS concentration (Equation 31.37):

$$\text{SS} = X = 3,125 \text{ mg/L}$$

- Load to be wasted:

$$Q_{\text{ex}} \cdot X = 89 \text{ m}^3/\text{d} \times 3,125 \text{ g/m}^3 \times 10^{-3} \text{ kg/g} = 275 \text{ kgSS/d}$$

As expected, this value is equal to the production of biological excess sludge (as calculated in Example 31.6), since the system is in equilibrium in the steady state (production = removal).

(b) Removal of excess sludge from the sludge recirculation line

- Daily flow to be wasted (Equation 31.38):

$$Q_{\text{ex}} = \frac{V}{\theta_c} \cdot \frac{X}{X_r} = \frac{535 \text{ m}^3}{6 \text{ d}} \cdot \frac{3,125 \text{ g/m}^3}{10,000 \text{ g/m}^3} = 28 \text{ m}^3/\text{d}$$

Due to the larger concentration of the removed sludge ($=X_r$), the flow of the excess sludge Q_{ex} is much smaller than that in the alternative method of direct extraction from the reactor ($Q_{\text{ex}} = 89 \text{ m}^3/\text{d}$).

- SS concentration (Equation 31.39):

$$\text{SS} = X_r = 10,000 \text{ mg/L}$$

Example 31.7 (Continued)

- Load to be wasted:

$$Q_{\text{ex}} \cdot X_r = 27.8 \text{ m}^3/\text{d} \times 10,000 \text{ g/m}^3 \times 10^{-3} \text{ kg/g} = 278 \text{ kgSS/d}$$

As expected, this value is equal to the production of excess sludge (as calculated in Example 31.6) and equal to the load to be extracted by the reactor in alternative “a” (any differences are due to rounding up).

With consideration of solids in the influent and effluent:

- BOD load removed (calculated in Example 31.6, item a):

$$S_r = 438 \text{ kgBOD/d}$$

- Load of SS produced:

From Table 31.4, sludge age of 6 days, considering solids in the influent and system with primary sedimentation tank: $P_x/S_r = 0.87$. Therefore, P_x is:

$$\begin{aligned} P_x &= (P_x/S_r) \cdot \text{BOD load removed} = 0.87 \text{ kgSS/kgBOD} \times 438 \text{ kgBOD/d} \\ &= 381 \text{ kgSS/d} \end{aligned}$$

- Load of SS escaping with the final effluent:

$$\begin{aligned} \text{Load SS effluent} &= Q \cdot X_e = 1,500 \text{ m}^3/\text{d} \times 30 \text{ mg/L} \times 10^{-3} \text{ kg/g} \\ &= 45 \text{ kgSS/d} \end{aligned}$$

- Excess sludge load to be removed daily:

$$\text{Load excess sludge} = P_x - \text{load SS effluent} = 381 - 45 = 336 \text{ kgSS/d}$$

Note: the SS load to be removed (equal to the production of biological solids), calculated in the first part of this example, was 278 kgSS/d.

(a) Removal of the excess sludge directly from the reactor (hydraulic control)

- Daily flow to be wasted (adaptation of Equation 31.40, discounting the solids in the effluent):

$$Q_{\text{ex}}' = \frac{\text{load excess sludge} \times 1,000}{X} = \frac{336 \times 1,000}{3,125} = 108 \text{ m}^3/\text{d}$$

- SS concentration (Equation 31.41):

$$\text{SS} = X = 3,125 \text{ mg/L}$$

Example 31.7 (Continued)**(b) Removal of excess sludge from the sludge recirculation line**

- Daily flow to be wasted (adaptation of Equation 31.42, discounting the solids in the effluent):

$$Q_{\text{ex}}' = \frac{\text{load excess sludge} \times 1,000}{X_r} = \frac{336 \times 1,000}{10,000} = 34 \text{ m}^3/\text{d}$$

- SS concentration (Equation 31.43):

$$\text{SS} = X_r = 10,000 \text{ mg/L}$$

The differences in loads and flows, compared to the calculations made in the first part of the example (without consideration of SS in the influent and effluent) should be noted.

31.10 OXYGEN REQUIREMENTS**31.10.1 Preliminaries**

In aerobic biological treatment, oxygen should be supplied to satisfy the following demands:

- *oxidation of the carbonaceous organic matter*
 - oxidation of the organic carbon to supply energy for bacterial *synthesis*
 - *endogenous respiration* of the bacterial cells
- *oxidation of the nitrogenous matter (nitrification)*

In systems with biological denitrification, oxygen savings due to denitrification can be taken into consideration.

The present section is devoted to the analysis of aspects related to the oxygen **consumption**. The aspects of oxygen **supply** are discussed in Chapter 11, which covers the aeration systems.

There are two ways to calculate the oxygen requirements for the satisfaction of the **carbonaceous** demand. Both are equivalent and interrelated, and naturally lead to the same values:

- method based on the total carbonaceous demand and on the removal of excess sludge
- method based on the oxygen demand for synthesis and for endogenous respiration

The oxygen demand for the **nitrification** is based on a stoichiometric relation with the oxidised ammonia. Although this chapter deals only with the removal of

the carbonaceous matter, the consumption of oxygen for nitrification should also be taken into consideration, since in warm-climate regions nitrification takes place almost systematically in systems designed for the removal of BOD.

31.10.2 Carbonaceous oxygen demand

(a) Method based on the total carbonaceous demand and the removal of excess sludge

The supply of oxygen for the carbonaceous demand should be the same as the consumption of oxygen for the ultimate BOD (BOD_u) removed by the system. This demand corresponds to the total oxygen demand for the oxidation of the substrate and for the endogenous respiration of the biomass. The ultimate BOD, in turn, is the same as the BOD_5 multiplied by a conversion factor that is in the range of 1.2 to 1.6 for domestic sewage. A value usually adopted is BOD_u/BOD_5 equal to 1.46. Thus, the mass of oxygen required per day can be determined as a function of the removed BOD_5 load:

$$OUR \text{ (kg/d)} = \frac{1.46 \cdot Q \cdot (S_o - S)}{10^3} \quad (31.44)$$

where:

- OUR = oxygen utilisation rate, or oxygen requirement (kgO_2/d)
- Q = influent flow (m^3/d)
- S_o = influent BOD_5 concentration (total BOD) (g/m^3)
- S = effluent BOD_5 concentration (soluble BOD) (g/m^3)
- 1.46 = conversion factor (BOD_u/BOD_5)
- 10^3 = conversion factor (g/kg)

However, in the activated sludge system, part of the influent organic matter is converted into new cells. A mass equivalent to that from the cells produced is wasted from the system (production = wastage in a system in the steady state). For this reason, the fraction corresponding to the oxygen consumed by these cells, which will not be completed inside the system, should be discounted from the total oxygen consumption. As demonstrated by Equations 31.11 and 31.12 (Section 31.6), each 1 g of cells consumes 1.42 g of oxygen for its stabilisation. Thus, Equation 31.44 can be expanded and written literally as:

$$OUR \text{ (kg/d)} = \text{Removed } BOD_u \text{ (kg/d)} - [1.42 \times (\text{solids produced})] \text{ (kg/d)} \quad (31.45)$$

The mass of volatile suspended solids produced per day (P_{xv}) is given by Equation 31.33 or 31.35. Thus, the consumption of oxygen for the stabilisation of the carbonaceous organic matter can be expressed through (Metcalf and Eddy, 1991):

$$OUR \text{ (kg/d)} = 1.46 \cdot Q \cdot (S_o - S) - 1.42 \cdot P_{xv} \quad (31.46)$$

By replacing P_{xv} in the above equation by the right-hand side of Equation 31.35 (equation that expresses P_{xv} in terms of Y_{obs}), another form of representing the consumption of oxygen is obtained, after some rearrangement:

$$\text{OUR (kg/d)} = Q \cdot (S_0 - S) \cdot \left(1.46 - \frac{1.42 \cdot Y}{1 + K_d \cdot f_b \cdot \theta_c} \right) \quad (31.47)$$

Example 31.8

Based on data from Example 9.10 (concerning the distribution of solids in the treatment), estimate the oxygen consumption for the oxidation of the carbonaceous matter in the conventional activated sludge ($\theta_c = 6$ days) and in the extended aeration ($\theta_c = 22$ days) systems.

Data:

Removed BOD load: $Q \cdot (S_0 - S) = 100.0$ kg/d

SSV production: $P_{xv} = 43.2$ kg/d (conventional activated sludge)

SSV production: $P_{xv} = 28.2$ (extended aeration)

Solution:

- Conventional activated sludge (Equation 31.46)

$$\begin{aligned} \text{OUR} &= 1.46 \cdot Q \cdot (S_0 - S) - 1.42 \cdot P_{xv} = 1.46 \times 100.0 - 1.42 \times 43.2 \\ &= 84.7 \text{ kgO}_2/\text{d} \end{aligned}$$

- Extended aeration (Equation 31.46)

$$\begin{aligned} \text{OUR} &= 1.46 \cdot Q \cdot (S_0 - S) - 1.42 \cdot P_{xv} = 1.46 \times 100.0 - 1.42 \times 28.2 \\ &= 106.0 \text{ kgO}_2/\text{d} \end{aligned}$$

As expected, the extended aeration leads to a greater oxygen consumption, compared with the conventional activated sludge system. In this example, the difference is due to the lower removal of the excess sludge in the extended aeration plant. If the conventional activated sludge system had included a primary sedimentation tank (as is usual), the influent BOD₅ load to the biological treatment stage would have been smaller, resulting in an even smaller oxygen consumption.

(b) Method based on the oxygen demand for substrate oxidation and endogenous respiration

The oxygen demand for the oxidation of the carbonaceous organic matter can be divided into two main components:

- oxygen demand for synthesis
- oxygen demand for endogenous respiration

The equation for the O_2 consumption can be obtained by rearranging Equation 31.46. Thus, if P_{xv} is replaced by the right-hand-side of Equation 31.33, one will arrive at the following:

$$\text{OUR (kg/d)} = 1.46 \cdot Q \cdot (S_o - S) - 1.42 \cdot P_{xv} \quad (31.46)$$

$$\text{OUR (kg/d)} = 1.46 \cdot Q \cdot (S_o - S) - 1.42 \cdot [Y \cdot Q \cdot (S_o - S) - f_b \cdot K_d \cdot X_v \cdot V] \quad (31.48)$$

$$\text{OUR (kg/d)} = (1.46 - 1.42 \cdot Y) \cdot Q \cdot (S_o - S) + 1.42 \cdot f_b \cdot K_d \cdot X_v \cdot V \quad (31.49)$$

The above equation can be expressed in the following simplified way:

$$\text{OUR (kg/d)} = a' \cdot Q \cdot (S_o - S) + b' \cdot X_v \cdot V \quad (31.50)$$

where:

$$a' = 1.46 - 1.42 \cdot Y$$

$$b' = 1.42 \cdot f_b \cdot K_d$$

This equation provides a very convenient way of expressing the oxygen consumption through its two main components: synthesis (first term on the right-hand side) and the biomass respiration (second term on the right-hand side). For example, in an existing system, the result of the manipulation of the concentration of the biomass (X_v) in the total oxygen consumption can be directly evaluated.

With respect to the coefficient values, it should be borne in mind that b' is a function of f_b , that is, indirectly, of θ_c . As a consequence, extended aeration systems should have smaller values of b' . However, as the volume V of the reactor is much larger in these systems, the term on the right-hand side (biomass respiration) is larger than that for the conventional activated sludge systems.

To allow expedited determinations of the average carbonaceous demand, Table 31.6 includes values of the $\text{OUR}/\text{BOD}_{\text{removed}}$, for different combinations of Y and K_d values.

With respect to Table 31.6, the following aspects are worth noting:

- The oxygen consumption for satisfaction of the carbonaceous demand increases with the sludge age.
- The lower sludge age range is more sensitive to the values of the coefficients Y and K_d . In the extended aeration range, the variation of the oxygen demand with the coefficients Y and K_d is smaller.

Table 31.6. Carbonaceous oxygen demand per unit of BOD_5 removed ($\text{kgO}_2/\text{kgBOD}_5 \text{ rem}$), in domestic sewage, for different values of Y and K_d

Coefficients		Sludge age (day)							
Y (g/g)	K_d (d^{-1})	2	6	10	14	18	22	26	30
0.5	0.09	0.84	0.95	1.02	1.07	1.10	1.13	1.14	1.14
0.6	0.08	0.70	0.83	0.91	0.97	1.01	1.05	1.07	1.07
0.7	0.07	0.57	0.70	0.80	0.86	0.91	0.95	0.98	1.01

- The estimation of the oxygen consumption for the oxidation of the carbonaceous matter does not depend on whether solids are present in the influent sewage.
- The values included refer to average flow and load conditions, and do not take into account adjustments for peak conditions (see example in Chapter 34).

Example 31.9

Based on data from Example 9.10 (concerning the distribution of solids in the treatment), estimate the oxygen consumption for the oxidation of the carbonaceous matter in the conventional activated sludge ($\theta_c = 6$ days) and in the extended aeration ($\theta_c = 22$ days) systems. Data are:

$$\begin{aligned}
 Q \cdot (S_o - S) &= 100.0 \text{ kg/d} & f_b &= 0.72 \text{ (conventional activated sludge)} \\
 Y &= 0.6 & f_b &= 0.57 \text{ (extended aeration)} \\
 K_d &= 0.09 \text{ d}^{-1}
 \end{aligned}$$

Solution:

(a) Conventional activated sludge

- Calculation of a' (Equation 31.50)

$$a' = 1.46 - 1.42 \cdot Y = 1.46 - 1.42 \times 0.6 = 0.608 \text{ kgO}_2/\text{kgBOD}_5$$

- Calculation of b' (Equation 31.50)

$$b' = 1.42 \cdot f_b \cdot K_d = 1.42 \times 0.72 \times 0.09 = 0.092 \text{ kgO}_2/\text{kgVSS} \cdot \text{d}$$

- Calculation of $X_v \cdot V$ (Equation 31.4)

$$V \cdot X_v = \frac{Y \cdot \theta_c \cdot Q \cdot (S_o - S)}{1 + f_b \cdot K_d \cdot \theta_c} = \frac{0.6 \times 6 \times 100.0}{1 + 0.72 \times 0.09 \times 6} = 259.2 \text{ kgVSS}$$

- Calculation of the O_2 consumption
 - synthesis: $a' \cdot Q \cdot (S_o - S) = 0.608 \times 100.0 = 60.8 \text{ kgO}_2/\text{d}$
 - biomass respiration: $b' \cdot X_v \cdot V = 0.092 \times 259.2 = 23.8 \text{ kgO}_2/\text{d}$
 - total: $60.8 + 23.8 = 84.6 \text{ kgO}_2/\text{d}$
- O_2/BOD_5 removed ratio:

$\text{OUR}/\text{BOD}_5 = 84.6/100.0 = 0.85 \text{ kgO}_2/\text{kgBOD}_5 \text{ rem}$ (very similar to the value given in Table 3.4 – notice the difference in the values of Y and K_d)

(b) Extended aeration

- Calculation of a' (same as item (a))

$$a' = 0.608 \text{ kgO}_2/\text{kgBOD}_5$$

Example 31.9 (Continued)

- Calculation of b' (Equation 31.50)

$$b' = 1.42 \cdot f_b \cdot K_d = 1.42 \times 0.57 \times 0.09 = 0.073 \text{ kgO}_2/\text{kgVSS}\cdot\text{d}$$

- Calculation of $X_v \cdot V$ (Equation 31.4)

$$V \cdot X_v = \frac{Y \cdot \theta_c \cdot Q \cdot (S_o - S)}{1 + f_b \cdot K_d \cdot \theta_c} = \frac{0.6 \times 22 \times 100.0}{1 + 0.57 \times 0.09 \times 22} = 620.1 \text{ kgVSS}$$

- Calculation of the O_2 consumption
 - synthesis: 60.8 kgO_2/d (same as item (a))
 - biomass respiration: $b' \cdot X_v \cdot V = 0.073 \times 620.1 = 45.3 \text{ kgO}_2/\text{d}$
 - total: $60.8 + 45.3 = 106.1 \text{ kgO}_2/\text{d}$
- O_2/BOD_5 removed ratio:

$\text{OUR}/\text{BOD}_5 = 106.1/100.0 = 1.06 \text{ kgO}_2/\text{kgBOD}_5 \text{ rem}$ (very similar to the value given in Table 31.6 – notice the difference in the values of Y and K_d)

(c) Summary

Variant	O ₂ consumption (kgO ₂ /d)		
	Synthesis	Respiration	Total
Conventional	60.8	23.8	84.6
Extended aeration	60.8	45.3	106.1

Therefore, it is observed that the larger oxygen consumption in the extended aeration plant compared to the conventional activated sludge is due to the biomass respiration. It can also be noticed that the total values of oxygen consumption are the same ones obtained in Example 31.8 (any differences are due to rounding up).

The O_2 consumption for biomass respiration can also be calculated by multiplying the load of destroyed biodegradable solids by the factor 1.42.

The present example assumed, for comparison purposes, that the conventional activated sludge plant had no primary sedimentation tank. In most real situations, primary clarifiers are included, leading to a reduction in the influent BOD load to the biological stage and, therefore, an even lower oxygen consumption.

The oxygen consumption calculated following the methods described above refers to the average steady-state conditions. During **peak hours**, the maximum influent flow usually coincides with the maximum concentration of influent BOD_5

(Metcalf and Eddy, 1991; von Sperling, 1994c). Thus, if both peaks are coincident, the maximum influent load of BOD₅ is $(Q_{\max}/Q_{\text{average}}) \times (\text{BOD}_{\max}/\text{BOD}_{\text{average}})$ times greater than the average load. However, the peak oxygen consumption does not necessarily coincide with the peak BOD₅ load, being dampened and lagged in some hours. The reason for this is that the soluble BOD is assimilated rapidly, while the particulate BOD takes some time to be hydrolysed (without oxygen consumption) and later assimilated (Cliff and Andrews, 1981). When calculating the total oxygen consumption, a **safety factor** should be included, which is associated with the influent peak load or with the maximum flow.

31.10.3 Oxygen demand for nitrification

Nitrification corresponds to the oxidation of ammonia to nitrite and, subsequently, to nitrate. This oxidation implies an oxygen consumption, which should be included in the total oxygen requirements. The organic nitrogen, also present in the raw sewage, does not directly undergo nitrification, but is initially converted into ammonia, which then results in its subsequent nitrification. Thus, it is assumed that the organic nitrogen and ammonia are capable of generating oxygen consumption in the nitrification process. The sum of the organic nitrogen and the ammonia nitrogen is represented by TKN (total Kjeldahl nitrogen).

The principles of nitrification, as well as the conditions for its occurrence, are discussed in Chapters 35 and 36. For the purpose of the current section, it is sufficient to know that, stoichiometrically:

1 g TKN requires 4.57 gO₂ for conversion to NO₃⁻

Thus:

$$\text{OUR (kg/d)} = 4.57 \cdot Q \cdot \text{TKN} / 10^3 \quad (31.51)$$

where:

TKN = total Kjeldahl nitrogen, equal to the organic nitrogen and the ammonia nitrogen (mgN/L)

In fact, it can be considered that in the raw sewage, TKN represents the total influent nitrogen, since nitrite and nitrate concentrations in the influent are normally negligible. Thus, TKN is the nitrogen potentially oxidisable to nitrate.

The bacteria responsible for nitrification have a very slow growth rate, besides being very sensitive to changes in the environmental conditions. Consequently, nitrification is subject to the compliance to some minimum criteria. In the conventional activated sludge system, in **warm-climate** countries, the chances of occurrence of nitrification are very high, even in activated sludge systems with low sludge ages, because of the high temperatures that accelerate the growth rate of the nitrifying bacteria. Therefore, even if only for safety reasons, it is recommended that the consumption of oxygen for nitrification should be added to the total oxygen requirements. In the extended aeration process, in view of the higher sludge ages that allow comfortably the growth of the nitrifying bacteria, it can be

considered that nitrification takes place systematically, unless some environmental restrictions (such as low dissolved oxygen) are present.

Denitrification implies decreased oxygen requirements. However, to obtain significant savings, denitrification should be included as a specific goal in the design of the plant. The presence of anoxic conditions is essential for the occurrence of denitrification.

31.11 NUTRIENT REQUIREMENTS

The microorganisms responsible for the oxidation of the organic matter require other nutrients, besides carbon, for their metabolic activities. The main nutrients are usually **nitrogen** and **phosphorus**, besides other elements in trace concentrations.

For the treatment system to remove BOD, organic carbon must be the limiting nutrient in the medium and the other nutrients must be present in concentrations above the minimum level required by the microorganisms. For domestic sewage this requirement is usually satisfied, while for certain industrial wastewaters there may be a lack of some nutrients, leading to a decrease in the biomass growth rate. In several situations, it is advantageous to combine domestic and industrial wastewaters in the public sewerage network, so that, after mixing and dilution, the influent to the treatment plant will be self-sufficient in terms of nutrient requirements.

The amount of N and P required depends on the composition of the biomass. When expressing the typical composition of a bacterial cell in terms of the empirical formulae $C_5H_7O_2N$ or $C_{60}H_{87}O_{23}N_{12}P$ (Metcalf and Eddy, 1991), the biomass synthesised in the treatment plant contains approximately 12.3% of nitrogen and 2.6% of phosphorus. The cellular residue after endogenous respiration has around 7% of nitrogen and 1% of phosphorus (Eckenfelder, 1980, 1989).

According to Eckenfelder (1980, 1989), the amount of **nitrogen** required is equivalent to the nitrogen removed from the system through the excess sludge. The main fractions are the nitrogen present in the active biomass that leaves the system in the form of excess sludge, and the nitrogen present in the non-active residue from the endogenous respiration. Based on the above mentioned percentages of the cellular composition, the nitrogen requirement can be estimated:

$$\begin{aligned} N_{\text{required}} = & N \text{ in the active cells from excess sludge} \\ & + N \text{ in the non-active cells of the excess sludge} \quad (31.52) \end{aligned}$$

$$N_{\text{req}} = 0.123 \cdot \left(\frac{f_b}{f_b'} \right) \cdot P_{xv} + 0.07 \cdot \left(1 - \frac{f_b}{f_b'} \right) \cdot P_{xv} \quad (31.53)$$

where:

N_{req} = required nitrogen load (kgN/d)

f_b = biodegradable fraction of the volatile suspended solids (SS_b/VSS)

f_b' = biodegradable fraction of the volatile suspended solids immediately after its generation, usually adopted as 0.8.

P_{xv} = net production of volatile suspended solids (kgVSS/d) = $X_v \cdot V / (10^3 \cdot \theta_c) = Y_{\text{obs}} \cdot Q \cdot (S_0 - S)$

Table 31.7. Minimum nutrient requirements

Activated sludge	θ_c (day)	Ratio between nutrients (in mass)		
		BOD ₅	N	P
Conventional	4–10	100	4.0–6.0	0.9–1.2
Extended aeration	20–30	100	2.5–3.5	0.5–0.6

Similarly, for **phosphorus**, one has:

$$P_{\text{req}} = 0.026 \cdot \left(\frac{f_b}{f_b'} \right) \cdot P_{\text{xv}} + 0.01 \cdot \left(1 - \frac{f_b}{f_b'} \right) \cdot P_{\text{xv}} \quad (31.54)$$

To be used by the microorganisms, the nitrogen needs to be in a form that can be assimilated, such as *ammonia* and *nitrate*. The organic nitrogen first needs to undergo hydrolysis to become available for the biomass.

It can be seen from Equations 31.53 and 31.54 that systems with a high sludge age, such as extended aeration, imply lower nutrient requirements, due to the lower production of excess sludge. Table 31.7 presents the ranges of N and P requirements for conventional activated sludge and extended aeration systems.

Values usually mentioned in literature are a BOD₅:N:P ratio of 100:5:1. However, it should be borne in mind that these values will apply only to the **conventional** activated sludge, as shown in Table 31.7.

Example 31.10

Calculate the nitrogen requirement for the two activated sludge systems described in Example 31.1. Important data from this and subsequent examples are:

- Conventional activated sludge:

$$\begin{aligned} \theta_c &= 6 \text{ days} & f_b &= 0.72 \\ X_v &= 2,500 \text{ mg/L} & S &= 8 \text{ mg/L} \\ V &= 535 \text{ m}^3 \end{aligned}$$

- Extended aeration:

$$\begin{aligned} \theta_c &= 22 \text{ days} & f_b &= 0.57 \\ X_v &= 3,000 \text{ mg/L} & S &= 3 \text{ mg/L} \\ V &= 1,067 \text{ m}^3 \end{aligned}$$

- General data:

$$\begin{aligned} S_o &= 300 \text{ mg/L} \\ \text{TKN} &= 45 \text{ mg/L} \\ Q &= 1,500 \text{ m}^3/\text{d} \end{aligned}$$

Example 31.10 (Continued)**Solution:****(a) Conventional activated sludge**

The production of biological solids P_{xv} is given by:

$$P_{xv} = \frac{X_v \cdot V}{10^3 \cdot \theta_c} = \frac{2,500 \times 535}{1000 \times 6} = 229 \text{ kgVSS/d}$$

According to Equation 31.53, the required daily nitrogen load is:

$$\begin{aligned} N_{\text{req}} &= 0.123 \cdot \left(\frac{f_b}{f_b'} \right) \cdot P_{xv} + 0.07 \cdot \left(1 - \frac{f_b}{f_b'} \right) \cdot P_{xv} \\ &= 0.123 \times \left(\frac{0.72}{0.80} \right) \times 229 + 0.07 \times \left(1 - \frac{0.72}{0.80} \right) \times 229 \\ N_{\text{req}} &= 24.7 + 1.6 = 26.3 \text{ kgN/d} \end{aligned}$$

(b) Extended aeration

The biological solids production P_{xv} is given by:

$$P_{xv} = \frac{X_v \cdot V}{10^3 \cdot \theta_c} = \frac{3,000 \times 1,067}{1000 \times 22} = 146 \text{ kgVSS/d}$$

According to Equation 31.53, the required daily nitrogen load is:

$$\begin{aligned} N_{\text{req}} &= 0.123 \cdot \left(\frac{f_b}{f_b'} \right) \cdot P_{xv} + 0.07 \cdot \left(1 - \frac{f_b}{f_b'} \right) \cdot P_{xv} \\ &= 0.123 \times \left(\frac{0.57}{0.80} \right) \times 146 + 0.07 \times \left(1 - \frac{0.57}{0.80} \right) \times 146 \\ N_{\text{req}} &= 12.8 + 2.9 = 15.7 \text{ kgN/d} \end{aligned}$$

(c) Available nitrogen

For comparison purposes, the influent nitrogen load (TKN) is:

$$\text{Influent TKN load} = \frac{Q \cdot \text{TKN}}{1,000} = 1,500 \frac{\text{m}^3}{\text{d}} \cdot 45 \frac{\text{g}}{\text{m}^3} \cdot \frac{1 \text{ kg}}{1,000 \text{ g}} = 67.5 \text{ kgTKN/d}$$

The influent nitrogen load expressed in terms of TKN is thus higher than the required load, in both activated sludge process variants.

(d) BOD:N ratio

The BOD consumed in the two systems is:

Example 31.10 (Continued)

- conventional activated sludge:

$$\text{BOD}_{\text{rem}} = \frac{Q \cdot (S_o - S)}{1,000} = 1,500 \frac{\text{m}^3}{\text{d}} \cdot (300 - 8) \frac{\text{g}}{\text{m}^3} \cdot \frac{1 \text{ kg}}{1,000 \text{ g}} = 438 \text{ kgBOD/d}$$

- extended aeration:

$$\text{BOD}_{\text{rem}} = \frac{Q \cdot (S_o - S)}{1,000} = 1,500 \frac{\text{m}^3}{\text{d}} \cdot (300 - 3) \frac{\text{g}}{\text{m}^3} \cdot \frac{1 \text{ kg}}{1,000 \text{ g}} = 446 \text{ kgBOD/d}$$

Thus, the required BOD:N ratio is:

- conventional activated sludge: BOD:N = 438:26.3 or **100:6.0**
- extended aeration: BOD:N = 446:15.7 or **100:3.5**

As can be seen, systems with higher sludge ages have lower nutrient requirements.

31.12 INFLUENCE OF THE TEMPERATURE

The temperature has a great influence on the microbial metabolism, thereby affecting the oxidation rates for the carbonaceous and nitrogenous matters.

In general terms and within certain limits, the rates of most chemical and biological reactions increase with temperature. In some chemical reactions, an approximate rule of thumb is that the reaction rate doubles for each increase of 10 °C in the medium temperature, resulting from the increased contact between the chemical molecules. In biological reactions, the tendency to increase the rates with the temperature will remain approximately valid up to a given optimum temperature. Above this temperature, the rate will decrease, due probably to the destruction of enzymes in the higher temperatures (Sawyer and Mc Carthy, 1978).

The relation between the temperature and the reaction coefficient can be expressed in the following manner:

$$K_T = K_{20} \cdot \theta^{(T-20)} \quad (31.55)$$

where:

K_T = reaction coefficient at a temperature T (d⁻¹)

K_{20} = reaction coefficient at a standard temperature of 20 °C (d⁻¹)

θ = temperature coefficient (-)

T = temperature of the medium (°C)

Equation 31.55 is usually valid in the temperature range from 4 to 30 °C, defined as the *mesophilic* range, in which most of the aerobic systems are included (see

Chapter 7). The biological activity can also take place in the *thermophilic* range, at higher temperatures, found for example, in some anaerobic systems and aerobic digestion systems.

The interpretation of the coefficient θ is made in the sense that, if θ is equal to, say, 1.02, the value of the reaction rate increases by 2% ($= 1.02 - 1.00 = 0.02$) for each increment of 1 °C in the temperature.

The influence of the temperature decreases with the increase of the sludge age (Eckenfelder, 1980) and is not of great significance in systems with high sludge ages (Ekama and Marais, 1977; Cook, 1983; Matsui and Kimata, 1986; Markantonatos, 1988; von Sperling and Lumbers, 1989), such as extended aeration. Additionally, compared with other treatment processes, the activated sludge system is less sensitive to temperature. According to Eckenfelder (1980), this is due to the fact that a great part of the BOD, present in the form of particulate BOD, is removed physically by adsorption in the floc, which is independent of temperature. For example, in aerated lagoons, with low solids concentrations, each organism is more directly affected by temperature changes, which justify the large value of θ .

The adaptation of the microorganisms to abrupt temperature changes seems to be much slower at higher temperatures. For example, it was observed that several months would be needed for the acclimatisation of the biomass to a change of 5 °C in the temperature range of 30 °C, while only 2 weeks were necessary for a similar adaptation in the range of 15 °C (Winkler, 1981).

Between 10 and 30 °C, μ_{\max} and K_d increase with temperature. K_s decreases slightly between 10 and 20 °C and increases substantially up to 30 °C. Y increases between 10 and 20 °C, but it decreases after that. Thus, the effect of the temperature on substrate removal depends on the combined effect of μ_{\max} , K_s and Y . Similarly, the effect on the production of solids depends on the combined effect on K_d and Y (Arceivala, 1981).

The Task Group for the IWA models (IAWPRC, 1987) recognises the difficulty in obtaining temperature correction rates for the model parameters (especially the K_s -type half-saturation constants), and suggests that the parameters are determined in operational conditions considered to be more critical. This aspect is particularly important in countries with a temperate climate, where the amplitude of temperature between winter and summer is significant. However, in many warm-climate countries the temperatures of the liquid are not substantially far from 20 °C, for which the kinetic parameters and stoichiometric coefficients are usually reported.

31.13 FUNCTIONAL RELATIONS WITH THE SLUDGE AGE

This section analyses the influence of the sludge age on selected important process parameters of the activated sludge system. All values have been calculated applying the model presented in this chapter.

To broaden the results, the values are given for three different combinations of the parameters Y and K_d , selected to reflect conditions of lower biomass production

(smaller Y and larger K_d) and of larger biomass production (larger Y and smaller K_d).

The main relations presented in Table 31.8 and in Figure 31.4 are (von Sperling, 1996d):

- *Production of suspended solids (SS) per unit of $BOD_5(S_r)$ removed.* Used for the estimation of the production of secondary excess sludge
- *Volatile suspended solids (VSS) to total suspended solids (SS) ratio.* Used in several design stages
- *Oxygen consumption (O_2) needed to satisfy the carbonaceous demand per unit of $BOD_5(S_r)$ removed.* Used for the design of the aeration system
- *Mass of mixed liquor volatile suspended solids required ($X_v \cdot V$) per unit of $BOD_5(S_r)$ removed.* With the product $X_v \cdot V$, for a given adopted value of the mixed liquor volatile suspended solids (X_v), the required volume for the reactor (V) may be determined

The following comments can be made with respect to Table 31.8 and Figure 31.4:

- The P_{SS}/S_r and VSS/SS ratios were presented in Section 31.9.1.
- The O_2/S_r ratio was presented in Section 31.10.2.
- The influence of the consideration of the influent solids to the reactor and of the presence of primary settling on the production of secondary excess sludge and on the VSS/SS ratio in the reactor can be seen clearly.
- The relations O_2/S_r and $X_v \cdot V/S_r$ are not affected by the presence of primary settling or solids in the influent. Obviously, in a system with primary settling the BOD load to the reactor will be lower, but the values of O_2 and $X_v \cdot V$ per unit of BOD removed in the reactor will be the same.
- The VSS/SS ratio is little affected by the values of the coefficients Y and K_d .
- The relations O_2/S_r and $X_v \cdot V/S_r$ are highly influenced by the values of the coefficients Y and K_d .

When using the data from Table 31.8 for a **quick design**, the following points should be taken into consideration (further details are given in Chapter 34):

- If *nitrification* is desired to be included in the computation of the average oxygen consumption (which is always advisable), the values of the O_2/S_r ratio in the above table starting from the sludge age of 4 days (in warm-climate regions) should be increased by around 50 to 60% (for typical values of influent TKN and assuming full nitrification, oxygen savings through the removal of nitrogen with the excess sludge and absence of intentional denitrification).
- To estimate the oxygenation capacity to be added to the system, the average oxygen consumption needs to be multiplied by a factor, such as the ratio between the maximum flow and the average flow (approximately 1.5 in medium to large plants, and 2.0 in smaller plants). This is the value of the oxygen demand in the *field*.

Table 31.8. Functional relations in the activated sludge system as a function of the presence of solids in the influent, existence of primary settling, coefficients Y and K_d and the sludge age

Item	Ratio and unit	SS in the influent	Primary settling	Coefficients		Sludge age (day)							
				Y (g/g)	K_d (d^{-1})	2	6	10	14	18	22	26	30
<i>Production of solids</i>	SS/ S_r (kgSS/ kgBOD ₅ rem)	No	No	0.5	0.09	0.50	0.42	0.37	0.33	0.31	0.29	0.28	0.28
				0.6	0.08	0.60	0.51	0.45	0.41	0.38	0.36	0.34	0.34
				0.7	0.07	0.71	0.61	0.55	0.50	0.47	0.44	0.42	0.40
			Yes	Yes	0.5	0.09	0.83	0.75	0.70	0.67	0.65	0.63	0.63
			Yes	Yes	0.6	0.08	0.96	0.87	0.81	0.78	0.75	0.73	0.71
			Yes	No	0.7	0.07	1.04	0.95	0.88	0.84	0.80	0.78	0.76
<i>VSS/SS ratio in reactor</i>	VSS/SS (g/g)	No	No	0.5	0.09	1.08	1.00	0.95	0.92	0.90	0.88	0.88	0.88
				0.6	0.08	1.23	1.14	1.09	1.05	1.02	1.00	0.98	0.98
				0.7	0.07	1.29	1.20	1.13	1.08	1.06	1.03	1.01	0.99
			Yes	No	0.5-0.7	0.07-0.09	0.89	0.87	0.85	0.84	0.83	0.82	0.81
			Yes	Yes	0.5-0.7	0.07-0.09	0.79	0.76	0.75	0.73	0.72	0.71	0.71
			Yes	No	0.5-0.7	0.07-0.09	0.75	0.73	0.71	0.70	0.69	0.69	0.68
<i>Carbonaceous oxygen demand</i>	O_2/S_r (kgO ₂ / kgBOD ₅ rem)	-	-	0.5	0.09	0.84	0.95	1.02	1.07	1.10	1.13	1.14	1.14
				0.6	0.08	0.70	0.83	0.91	0.97	1.01	1.05	1.07	1.07
				0.7	0.07	0.57	0.70	0.80	0.86	0.91	0.95	0.98	1.01
<i>Volume of the reactor</i>	$X_v \cdot V/S_r$ [kgV/SS/ (kgBOD ₅ /d)]	-	-	0.5	0.09	0.88	2.16	3.11	3.88	4.55	5.15	5.71	6.24
				0.6	0.08	1.07	2.67	3.87	4.85	5.70	6.47	7.17	7.84
				0.7	0.07	1.26	3.21	4.69	5.92	6.98	7.93	8.80	9.62

Notes:

- Highlighted values: More usual values in activated sludge plants with typical flowsheets
- Per capita contributions: BOD₅ = 50 g/inhabitant-d; SS = 60 g/inhabitant-day
- Removal efficiencies in the primary sedimentation tank: BOD = 30%; SS = 60%
- S_r : Removed BOD₅ load (kgBOD₅/d)

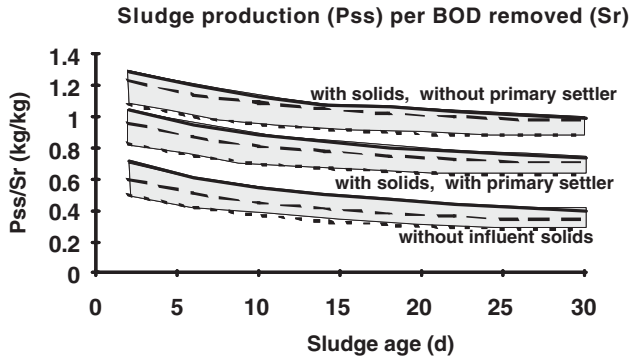

(in each range: lower curve: $Y = 0.5$ and $K_d = 0.09 \text{ d}^{-1}$; intermediate curve: $Y = 0.6$ and $K_d = 0.08 \text{ d}^{-1}$; upper curve: $Y = 0.7$ and $K_d = 0.07 \text{ d}^{-1}$)

Conventional activated sludge systems ($\theta_c \leq 10 \text{ d}$) usually include primary settling, while extended aeration systems ($\theta_c \geq 18 \text{ d}$) do not usually include primary settling

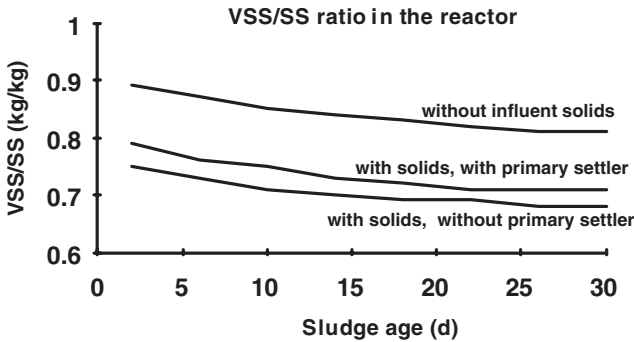

(variation of the coefficients Y and K_d : small influence; not considered)

Conventional activated sludge systems ($\theta_c \leq 10 \text{ d}$) usually include primary settling, while extended aeration systems ($\theta_c \geq 18 \text{ d}$) do not usually include primary settling

Figure 31.4. Functional relations of process variables with the sludge age

- If one wants to express the oxygen demand under *standard conditions* (20°C , clean water, sea level), the field demand has to be divided by a factor between 0.55 and 0.65.
- If one wants to express the relations in terms of the BOD load *applied* to the reactor, instead of the *removed* load, the corresponding values must be multiplied by 0.93 to 0.98, which correspond to the typical BOD removal efficiencies $[(S_o - S)/S_o]$.

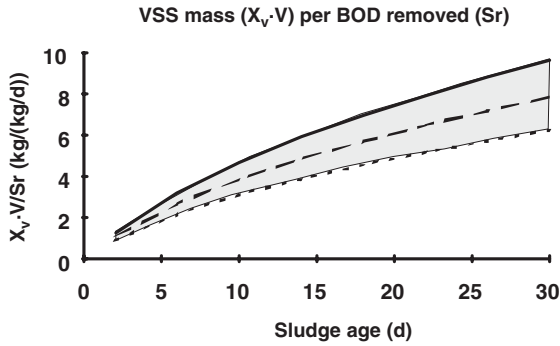

(in the range: lower curve: $Y = 0.5$ and $K_d = 0.09 \text{ d}^{-1}$; intermediate curve: $Y = 0.6$ and $K_d = 0.08 \text{ d}^{-1}$; upper curve: $Y = 0.7$ and $K_d = 0.07 \text{ d}^{-1}$)

To obtain the required reactor volume, simply divide the value of $X_v \cdot V$ (kg) by the adopted value of X_v (kg/m^3)

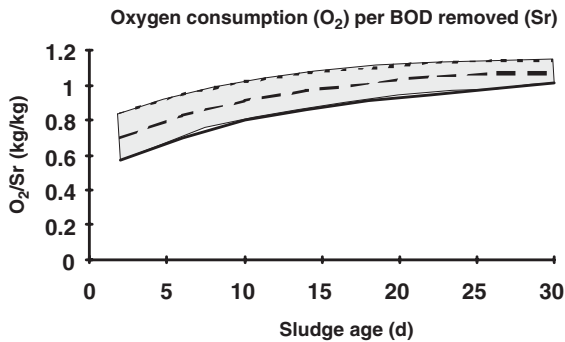

(in the range: lower curve: $Y = 0.7$ and $K_d = 0.07 \text{ d}^{-1}$; intermediate curve: $Y = 0.6$ and $K_d = 0.08 \text{ d}^{-1}$; upper curve: $Y = 0.5$ and $K_d = 0.09 \text{ d}^{-1}$)

This consumption is for the average carbonaceous demand. To obtain the total demand, the consumption for nitrification and the provision of oxygen for the maximum flow must be considered

Figure 31.4 (Continued)

To facilitate the implementation of a quick automated design tool in the computer, thus avoiding the need to refer to Table 31.8 and allowing a continuous solution for any sludge age within the range (not only those given in Table 31.8), von Sperling (1996d) made regression analyses which correlated the various variables and ratios in Table 31.8 with the sludge age. The structure adopted for the regression equation was the multiplicative ($y = a \cdot x^b$). The results are included in Table 31.9.

In all the regressions the fitting was excellent (coefficients of determination R^2 greater than 0.98). The utilisation of the equations is as follows. For example,

Table 31.9. Regression analysis comparing several relations included in Table 31.8 and the sludge age (influent solids considered)

Relation (y)	Solids in the influent	Primary settling	Coefficients		Equation $y = a \cdot (\theta_c)^b$	
			Y (g/g)	K_d (d^{-1})	a	b
SS/S_r (kgSS/ kgBOD ₅ rem)	Yes	Yes	0.5	0.09	0.900	-0.110
			0.6	0.08	1.053	-0.115
			0.7	0.07	1.158	-0.126
	Yes	No	0.5	0.09	1.145	-0.081
			0.6	0.08	1.318	-0.087
			0.7	0.07	1.401	-0.098
VSS/SS (g/g)	Yes	Yes	0.5–0.7	0.07–0.09	0.817	-0.043
	Yes	No	0.5–0.7	0.07–0.09	0.774	-0.038
O_2/S_r (kgO ₂ / kgBOD ₅ rem)	–	–	0.5	0.09	0.777	0.118
			0.6	0.08	0.630	0.161
			0.7	0.07	0.483	0.218
$X_v \cdot V/S_r$ [kgVSS/ (kgBOD ₅ /d)]	–	–	0.5	0.09	0.662	0.663
			0.6	0.08	0.809	0.671
			0.7	0.07	0.959	0.682

the oxygen consumption per unit of BOD removed (O_2/S_r) for the sludge age of 8 days and the intermediate coefficient values ($Y = 0.6$ and $K_d = 0.08 d^{-1}$) will be (from Table 31.9) $a = 0.630$ and $b = 0.161$. The equation is: $O_2/S_r = 0.630 \cdot (\theta_c)^{0.161} = 0.630 \times (8)^{0.161} = 0.88$ kgO₂/kgBOD₅ removed. This value is consistent with Table 31.8, after interpolating between the sludge ages of 6 and 10 days.

The *detailed* design sequence of the activated sludge, using the various process formulae introduced in this chapter, is presented in Chapter 34.

Example 31.11

Undertake a **quick design** of the biological reactor, based on the data included in Table 31.8 and the associated remarks. Determine the volume of the reactor, the oxygen consumption, the power of the aerators and the production and removal of the excess sludge. Consider an extended aeration plant, with a sludge age of 25 days and a MLVSS concentration of 3,500 mg/L. Use the influent load of 3,350 kgBOD₅/d (estimated in the example in Chapter 2 and also adopted in the detailed design in Chapter 34). Take into account the solids in the influent and assume that the system will not have primary settling.

Solution:

(a) Estimation of the removed BOD load

The removed BOD load can be estimated as 95% of the applied BOD. Thus:

$$S_r = 0.95 \times 3,350 \text{ kgBOD}_5/\text{d} = 3,183 \text{ kgBOD}_5/\text{d}$$

Example 31.11 (Continued)**(b) Estimation of the VSS/SS ratio in the reactor and the resulting MLSS concentration**

According to Table 31.8 (considering the influent solids and not using primary settling), after a linear interpolation between the sludge ages of 22 and 26 days for the sludge age of 25 days, one gets: **VSS/SS = 0.68**.

For $X_v = 3,500$ mgMLVSS/L, the resulting MLSS concentration is:

$$\text{MLSS} = 3,500/0.68 = \mathbf{5,147 \text{ mg/L}} = 5.147 \text{ kg/m}^3$$

(c) Estimation of the reactor volume

According to Table 31.8, by adopting the intermediate coefficient values ($Y = 0.6$; $K_d = 0.08 \text{ d}^{-1}$) and interpolating between the sludge ages of 22 and 26 days, one gets: $X_v \cdot V/S_r = 7.0 \text{ d}^{-1}$.

For $X_v = 3.5 \text{ kg/m}^3$ ($= 3,500$ mgMLVSS/L) and $S_r = 3,183 \text{ kgBOD}_5/\text{d}$, the resulting reactor volume is:

$$V = 7.0 \times 3,183/3.5 = \mathbf{6,366 \text{ m}^3}$$

(d) Estimation of the production and removal of excess sludge

According to Table 31.8, by considering the influent solids and not adopting primary settling, one gets: $P_x/S_r = 0.98$ (interpolating between the sludge ages of 22 and 26 days).

For $S_r = 3,183 \text{ kgBOD}_5/\text{d}$, the sludge production is calculated as:

$$P_x = 0.98 \times 3,183 = \mathbf{3,119 \text{ kgSS/d}}$$

If the sludge is removed directly from the reactor, its concentration is the same as MLSS (X). Thus, the excess sludge flow is (disregarding the loss of solids in the final effluent) is:

$$Q_{\text{ex reactor}} = P_x/X = 3,119/5.147 = \mathbf{606 \text{ m}^3/\text{d}}$$

Note that this value is different from the value V/θ_c ($= 6,366/25 = 255 \text{ m}^3/\text{d}$), usually adopted when controlling the system by the sludge age (hydraulic control), disregarding the influent solids.

If the sludge is removed from the return sludge line, its concentration is the same as RASS (X_r). For a recirculation ratio $R (= Q_r/Q)$ equal to 1.0 (adopted), one has:

$$X_r = X \cdot (R + 1)/R = 5.147 \times (1 + 1)/1 = 10.294 \text{ kg/m}^3 (= 10,294 \text{ mg/L})$$

$$Q_{\text{ex return sludge line}} = P_x/X_r = 3,119/10.294 = \mathbf{303 \text{ m}^3/\text{d}}$$

Example 31.11 (Continued)

The excess sludge flow removed from the return sludge line ($303 \text{ m}^3/\text{d}$) is half of the flow removed from the reactor ($606 \text{ m}^3/\text{d}$), due to the fact that the solids concentration in the return sludge line ($10,294 \text{ mg/L}$) is twice the concentration in the reactor ($5,147 \text{ mg/L}$).

(e) Calculation of the oxygen consumption and aerator power requirements

According to Table 31.8, $O_2/S_r = 1.06 \text{ kgO}_2/\text{kgBOD}_5$ (interpolating between the sludge ages of 22 and 26 days).

For $S_r = 3,183 \text{ kgBOD}_5/\text{d}$:

$$\begin{aligned} O_2 \text{ carbonaceous} &= 1.06 \times 3,183 \\ &= 3,374 \text{ kgO}_2/\text{d} \text{ (average carbonaceous demand)} \end{aligned}$$

To take into account the nitrification in the total O_2 consumption, the carbonaceous demand value must be increased by 50 to 60%. By adopting a value of 55%, the total average demand (disregarding denitrification) is:

$$O_2 \text{ total} = 1.55 \times 3,374 = 5,230 \text{ kgO}_2/\text{d}$$

To take into account the demand under maximum load conditions, the average oxygen demand must be multiplied by a correction factor. This factor may be adopted varying between 1.5 and 2.0 ($\approx Q_{\max}/Q_{\text{average}}$), depending on the size of the plant. Adopting a factor of 2.0, one has:

$$\begin{aligned} \text{Total maximum } O_2 &= 2.0 \times 5,230 \\ &= 10,460 \text{ kgO}_2/\text{d} \text{ (in the field, under operational conditions)} \end{aligned}$$

To express it in standard conditions, the field value should be divided by a factor that varies between 0.55 and 0.65. By adopting the value of 0.60, one has:

$$O_2 \text{ standard} = 10,460/0.60 = 17,433 \text{ kgO}_2/\text{d} = 726 \text{ kgO}_2/\text{hour}$$

By adopting a standard oxygenation efficiency of $1.8 \text{ kgO}_2/\text{kW}\cdot\text{hour}$ for mechanical aeration (see Chapter 11), the power requirement is:

$$\text{Power required} = 726/1.8 = 403 \text{ kW} = 537 \text{ HP}$$

(f) Comments

- If the detailed design sequence presented in Chapter 34 had been followed, it could be verified that the values found for the volume of the reactor,

Example 31.11 (Continued)

production of excess sludge and oxygen requirements are very similar to those obtained in the present quick design (differences of less than 2.5%).

- This example could have been also undertaken based on the equations presented in Table 31.9. The results obtained should be very similar.
- The design did not foresee the intentional denitrification in the reactor. Although still little used in most developing countries, its implementation in a more systematic way should be encouraged, especially in warm-climate countries.
- To complete the plant, the designs of the secondary sedimentation tanks and the preliminary treatment units (screen and grit chamber) and sludge processing units (thickening and dewatering) are still needed. The design of these units is simpler than the design of the reactor and associated variables.

Design of continuous-flow activated sludge reactors for organic matter removal

32.1 SELECTION OF THE SLUDGE AGE

The selection of the sludge age is the main step in the design of an activated sludge plant. As shown in Section 31.19, several process variables are directly associated with the sludge age. The first decision concerns the selection of θ_c values that place the plant within one of the main operational ranges presented in Table 30.1 (Chapter 30). Tables 30.3 and 30.4 in the same chapter present a comparison among the main activated sludge variants (conventional activated sludge, extended aeration), focusing on several important aspects.

The advantages of incorporating the UASB reactor upstream the activated sludge system were presented in Section 30.2.5. The main design parameters of this configuration are detailed in Chapter 38. Due to the large number of advantages in warm-climate regions, it is recommended that this alternative be carefully analysed by the designer, prior to making a decision for the classical conceptions (without UASB reactor).

With relation to the classical conceptions, the first decision to be taken by the designer is the adoption of either conventional activated sludge or extended aeration. Although there are no fixed rules, the following approximate applicability

ranges could be mentioned as an initial guideline in preliminary studies:

- smaller plants (less than $\approx 50,000$ inhabitants): extended aeration
- intermediate plants (between $\approx 50,000$ and $\approx 150,000$ inhabitants): technical–economical studies
- larger plants (more than $\approx 150,000$ inhabitants): conventional activated sludge

In smaller plants, operational simplicity has a strong weight, which leads to the extended aeration alternative. In larger plants, the economy in power

Table 32.1. Design parameters for carbon removal in the biological reactor

Category	Parameter	Conventional activated sludge	Extended aeration
<i>Parameter to be initially assumed</i>	Sludge age (d)	4–10	18–30
	MLVSS concentration (mg/L)	1,500–3,500	2,500–4,000
	Effluent SS (mg/L)	10–30	10–30
	Return sludge ratio (Q_r/Q)	0.6–1.0	0.8–1.2
	Average DO concentration in the reactor (mg/L)	1.5–2.0	1.5–2.0
<i>Data resulting from the design or parameter to be used in quick designs</i>	F/M ratio (kgBOD ₅ /kgMLVSS·d)	0.3–0.8	0.08–0.15
	Hydraulic detention time (hour)	6–8	16–24
	MLSS concentration (mg/L)	2,000–4,000	3,500–5,000
	VSS/SS ratio in the reactor (–)	0.70–0.85	0.60–0.75
	Biodegradable fraction of MLVSS (f_b) (–)	0.55–0.70	0.40–0.65
	BOD removal efficiency (%)	85–93	90–98
	Effluent soluble BOD ₅ (mg/L)	5–20	1–4
	BOD ₅ of the effluent SS (mgBOD ₅ /mgSS)	0.45–0.65	0.20–0.50
	VSS production per BOD ₅ removed (kgVSS/kgBOD ₅)	0.5–1.0	0.5–0.7
	Excess sludge production per BOD ₅ rem. (kgSS/kgBOD ₅)	0.7–1.0	0.9–1.1
	Average O ₂ requirements (without nitrification) (kgO ₂ /kgBOD ₅)	0.7–1.0	–
	Average O ₂ requirements with nitrification (kgO ₂ /kgBOD ₅)	1.1–1.5	1.5–1.8
	Nutrient requirements – nitrogen (kgN/100 kgBOD ₅)	4.3–5.6	2.6–3.2
	Nutrient requirements – phosphorus (kgP/100 kgBOD ₅)	0.9–1.2	0.5–0.6
	N removed per BOD ₅ removed (kgN/100 kgBOD ₅)	0.4–1.0	0.1–0.4
	P removed per BOD ₅ removed (kgP/100 kgBOD ₅)	4–5	2.4

Sources: Arceivala (1981), Orhon and Artan (1994) and the author's adaptations

consumption assumes great importance, and the operational issue is no longer critical, leading to the conventional activated sludge system. In intermediate plants these items overlap, and more detailed technical and economical assessments are necessary.

After the selection concerning the sludge age range, a refinement should be performed, and the ideal sludge age should be selected for the system at issue. Depending on the degree of detail desired, the selection can be made based on either economic assessments, a simple comparison between volumes, areas, and required powers, obtained from a preliminary design, or even be based on the designer's experience. The figures, tables and equations presented in Section 31.13 can aid in this selection process.

32.2 DESIGN PARAMETERS

The main parameters for the design of a reactor aiming at the removal of organic carbon (BOD) are listed in Table 32.1.

The kinetic and stoichiometric coefficients necessary for the design of the BOD removal stage are summarised in Table 32.2.

Table 32.2. Kinetic and stoichiometric coefficients and basic relations for the calculation of the BOD removal in activated sludge systems

Coefficient	Description	Unit	Range	Typical value
Y	Yield coefficient (cellular production)	gVSS/gBOD ₅	0.4–0.8	0.6
K _d	Endogenous respiration coefficient	gVSS/gVSS-d	0.06–0.10	0.08–0.09
θ	Temperature coefficient for K _d	–	1.05–1.09	1.07
f' _b	Biodegradable fraction when generating solids (X _b /X _v)	gSS _b /gVSS	–	0.80
VSS/SS	SSV/SS in the raw sewage	gVSS/gSS	0.70–0.85	0.80
SS _b /SS	SS _{biodegradable} /SS in the raw sewage	gSS _b /SS	–	0.60
VSS/SS	SSV/SS when generating solids	gVSS/gSS	–	0.90
O ₂ /SS _b	Oxygen per biodegradable solids destroyed	gBOD _u /gSS _b	–	1.42
BOD _u /BOD ₅	BOD _{ultimate} /BOD ₅ ratio	gBOD _u /gBOD ₅	1.2–1.5	1.46

Base: BOD₅ and VSS; temperature = 20 °C

Sources: Eckenfelder (1989), Metcalf and Eddy (1991), WEF/ASCE (1992), Orhon and Artan (1994), and von Sperling (1996d)

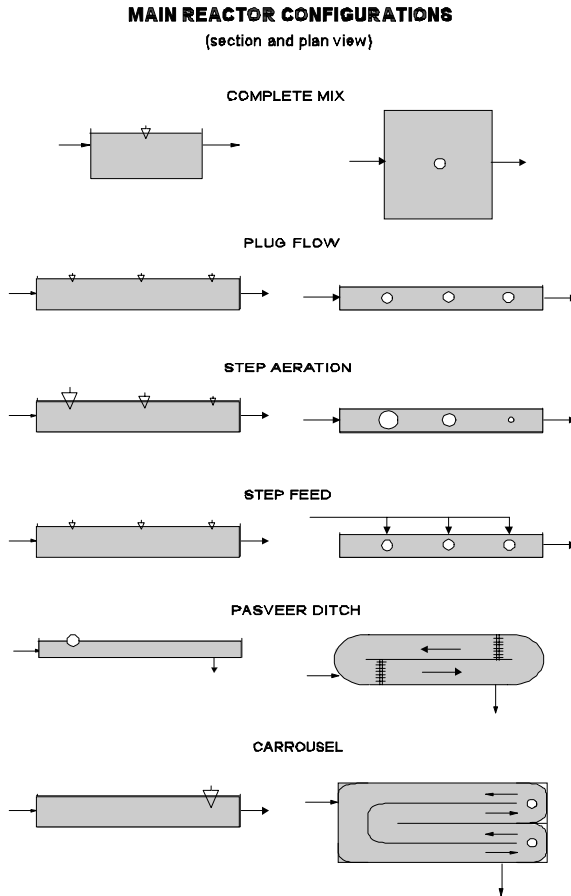

Figure 32.1. Simplified schematics of the main physical configurations of activated sludge reactors (section and plan view)







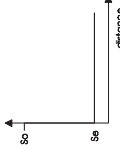
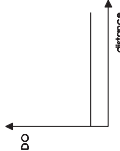

32.3 PHYSICAL CONFIGURATION OF THE REACTOR

There are several variants in the design of continuous-flow activated sludge systems regarding the physical configuration of the biological reactor. Table 32.3 presents a summary of the main variants, and Figure 32.1 shows schematic sections and plan views. Chapter 8 presents a detailed description and a comparison between the complete-mix and plug-flow reactors.

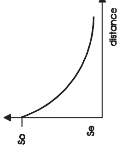
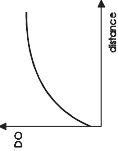
The Pasveer- and Carrousel-type **oxidation ditches** deserve some additional considerations. Regarding the mixing regime, the oxidation ditches have the following characteristics (Johnstone *et al.*, 1983):

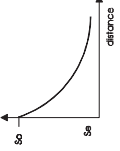
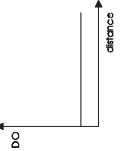
- *complete-mix* behaviour for most of the variables (such as BOD and suspended solids)

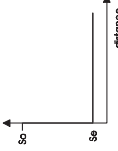
Table 32.3. Description of the main physical configurations of activated sludge reactors

<i>Variant</i>	Scheme	Description	Longitudinal BOD profile	Longitudinal DO profile
<i>Complete mix</i>		<ul style="list-style-type: none"> • Predominantly square dimensions • The concentrations are the same at any point of the reactor • Higher resistance to overloads and toxic substances • Suitable for industrial wastes 		
<i>Plug flow</i>		<ul style="list-style-type: none"> • Predominantly longitudinal dimensions • More efficient than the complete-mix reactor • Capable of producing sludge with better settleability • The oxygen demand decreases along the reactor • The DO concentration increases along the reactor • Less resistant to shock loads 		
<i>Step aeration</i>		<ul style="list-style-type: none"> • Similar to the plug flow • The oxygen demand decreases along the reactor • The oxygen supply is equal to the demand (the aeration decreases along the reactor) • Savings in oxygen supply • Easier control by diffused air 		
<i>Step feeding</i>		<ul style="list-style-type: none"> • Inlet to the reactor at several points • The reactor behaves as a complete-mix reactor • The oxygen consumption is homogeneous • Operationally flexible • Possibility of temporary solids storage in the initial part, if the initial inlet is closed 		

*Pasveer-
type
oxidation
ditch*

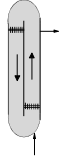

- The reactor has an oval shape
- The liquid circulates at a high speed in the reactor by the impulse of horizontal shaft rotors
- Used in extended aeration mode
- The reactor behaves as plug flow for DO (higher DO close to the aerators) and complete mix for the other variables
- The existence of anoxic zones can enable denitrification
- The horizontal shaft rotors require low tank depths (larger area requirements)

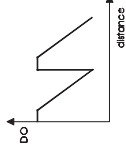
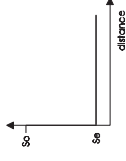

*Carrousel-
type
oxidation
ditch*

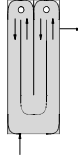

- Similar to the Pasveer ditch
- The vertical shaft aerators can work in deeper tanks, thus requiring a smaller area

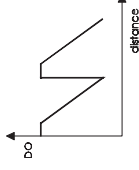
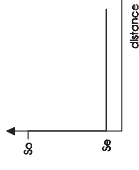

- *plug-flow* behaviour for variables with fast dynamics (such as dissolved oxygen)

This double behaviour results from the interrelation between the hydraulic dynamics of the reactor and the dynamics of the reaction rates of the variables. The dilution capacity of a ditch is high, due to the high horizontal velocity, which allows a complete circuit around the ditch in 15 to 20 minutes. Thus, variables with relatively slow dynamics, such as most of the variables involved in wastewater treatment, present approximately the same concentration at any point of the reactor, characterising a hydraulic regime approaching complete mix. However, variables with fast dynamics, such as dissolved oxygen, present a concentration gradient along the reactor, approaching the plug-flow regime. In spite of the fast flow velocities, the oxygen reaction rate (production and consumption) velocity is higher. The liquid has high DO concentrations soon after leaving the aerator. As the liquid flows downstream, the oxygen is consumed to satisfy various oxygen demands, and its concentration decreases until it reaches another aerator (or the same one, if there is only one).

The existence of this oxygen gradient in oxidation ditches affects all the variables that depend, either directly or indirectly, on dissolved oxygen. The DO values are always closely related to the place where they are measured. Monod's relations, which include oxygen as a substrate, are specific to each ditch, in view of its geometry, travel time of the liquid, oxygen utilisation rate and, above all, the DO measurement location. The comparison between DO values from ditch to ditch only makes sense when they represent approximately the same measuring location. Generalisations in relation to optimum DO values for aerator on/off or outlet weir level setting in automated aeration level control systems are also limited by the existing variations from ditch to ditch. The alternation between high and low DO values along the ditch can also have a great influence on nitrification and denitrification processes, as described in Chapter 36.

32.4 DESIGN DETAILS

Some aspects of the design of activated sludge reactors are listed below.

General aspects:

- The length and width of the reactor should allow a homogeneous distribution of the aerators on the surface of the tank.
- The liquid depth of the reactor is within the following range: 3.5 to 4.5 m (mechanical aeration) and 4.5 to 6.0 m (diffused air).
- The depth of the reactor should be established in accordance with the aerator to be adopted (consult the manufacturer's catalogue).
- The freeboard of the tank is approximately 0.5 m.
- The plan dimensions should be established according to the hydraulic regime selected, and should be compatible with the areas of influence of the aerators.

- In plants with a high flow (say, >200 L/s), more than one reactor should be adopted.
- The tanks are usually made of reinforced concrete with vertical walls but, whenever possible, the alternative of sloped tanks should be analysed (lighter wall structure and foundations).
- Should there be more than one unit, common walls can be used between them.
- Low-speed fixed mechanical aerators should be supported by catwalks and pillars (designed to resist torsion). High-speed floating mechanical aerators are anchored to the borders.
- Mechanical aerators may have their oxygenation capacity controlled by means of a variable submergence of the aerators (variation in the level of the outlet weir or in the aerator shaft), by a variable speed of the aerators or by switching on/off the aerators.
- The diffused-air aeration can have its oxygenation capacity controlled by means of adjustment in the outlet valves from the blowers or in the inlet valves in the reactors.
- A submerged inlet avoids the release of hydrogen sulphide present in the raw sewage.
- The outlet from the tank is generally by weirs at the opposite end to the inlet.
- If there is more than one tank, the inlet and outlet arrangements should allow the isolation of one unit for occasional maintenance.
- The scum occasionally formed should be broken by means of hoses or sprinklers, and be either removed to scum boxes or directed to secondary sedimentation tanks.
- The possible drainage of the tank (occasional emptying for maintenance purposes) by means of submersible pumps (simpler and more reliable) or by bottom discharge valves should be considered.
- In case of interference with the groundwater level, there should be a means to relieve the sub-pressure when the tank is empty.

Oxidation ditches:

- The oxidation ditches are designed using the same principles as those used for the design of other extended aeration reactors, resulting in the same reactor volumes and oxygen demands.
- The aerators have horizontal shaft in the Pasveer-type ditches and vertical shaft in the Carrousel-type ditches.
- The aerators should ensure a horizontal velocity between 0.30 and 0.50 m/s, to avoid the sedimentation of solids in the reactor.
- Pasveer-type oxidation ditches usually have a maximum depth of approximately 1.2 m, in view of the limited capacity of the horizontal-shaft rotors to transfer oxygen and maintain the liquid in movement at higher depths.
- Carrousel oxidation ditches are deeper as a result of the type of aerator employed (vertical shaft), which leads to a lower land requirement, compared

with the Pasveer ditch. Depths can be up to 5 m in the aeration zone, and approximately 3.5 m in the non-aerated zone.

- Smaller ditches can have their walls sloped at 45° , while larger ditches have vertical walls.
- There is no maximum number of curves between each aerator. However, it is suggested that the sum of the curves does not exceed 360° between one aerator and another.
- To avoid stagnation and solids sedimentation zones in the internal face of the dividing wall, downstream the curve, additional inner semi-circular walls following the curve can be adopted. These walls are slightly decentralised in relation to the internal wall: the largest opening receives most of the liquid, while the smallest opening discharges this larger portion of the liquid at a higher speed, in the downstream zone, internally to the central wall, thus avoiding the sedimentation of solids.

33

Design of activated sludge sedimentation tanks

33.1 TYPES OF SEDIMENTATION TANKS

This chapter mostly deals with *secondary* sedimentation tanks, in view of their fundamental importance in the biological stage of the activated sludge process. However, the design of *primary* sedimentation tanks is briefly covered in Section 33.4.

The most used shapes for the secondary sedimentation tanks are the *horizontal-flow rectangular tank* and the *central-feeding circular tank*. Both tanks require the continuous removal of sludge by scrapers or bottom suction. A schematic view of both tanks can be seen in Figures 33.1 and 33.2. The circular tank allows an easier continuous removal of sludge, besides the greater structural advantage of the ring effect. On the other hand, the rectangular tank allows a larger economy of area (absence of dead areas between tanks) and the possibility of using common walls between adjoining tanks. Both tanks are used in medium- and large-sized plants.

In small-sized plants, sludge removal mechanisms will not be necessary if the bottom has a high slope (approximately 60° with relation to the horizontal line), assuming the shape of an inverted pyramid. The sludge is thus directed to the bottom sludge hoppers, from where it is removed by hydraulic pressure. These tanks are named *Dortmund* tanks. Their use is restricted to smaller plants, due to the fact that high bottom slopes require very large depths in case of large surface areas. Figure 33.3 exemplifies one possible shape for this tank, rectangular in the upper plan, but divided into three equal chambers.

HORIZONTAL-FLOW RECTANGULAR SEDIMENTATION TANK

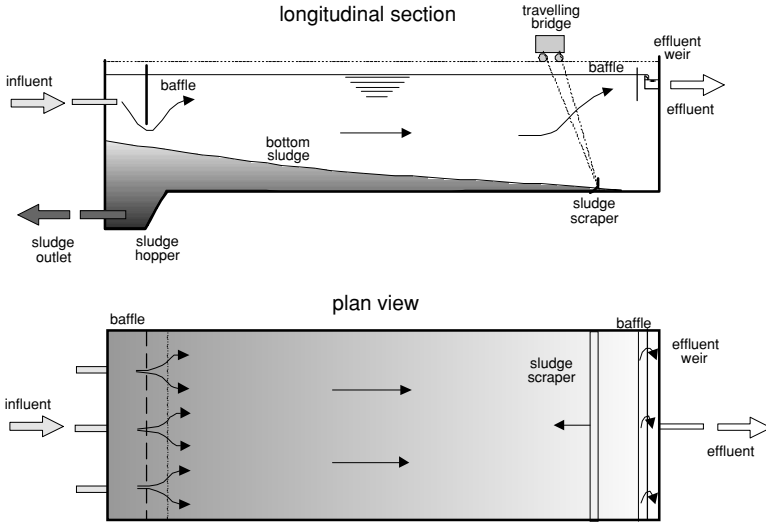

Figure 33.1. Schematics of a rectangular secondary sedimentation tank (section and plan view)

Section 33.2 deals with the determination of the main design aspect (surface area of the sedimentation tanks), while Section 33.3 presents several design details for the three types of sedimentation tanks mentioned.

33.2 DETERMINATION OF THE SURFACE AREA REQUIRED FOR SECONDARY SEDIMENTATION TANKS

33.2.1 Determination of the surface area according to conventional hydraulic loading rates and solids loading rates

The calculation of the required surface area is the main aspect in the design of a sedimentation tank. The area is usually determined by considering the following design parameters:

- **Hydraulic loading rate: (Q/A) .** It corresponds to the quotient between the influent flow to the plant (Q) and the surface area of the sedimentation tanks (A).
- **Solids loading rate: $(Q + Q_r) \cdot X/A$.** It corresponds to the quotient between the applied solids load $(Q + Q_r) \cdot X$ and the surface area of the sedimentation tanks (A).

CIRCULAR SEDIMENTATION TANK

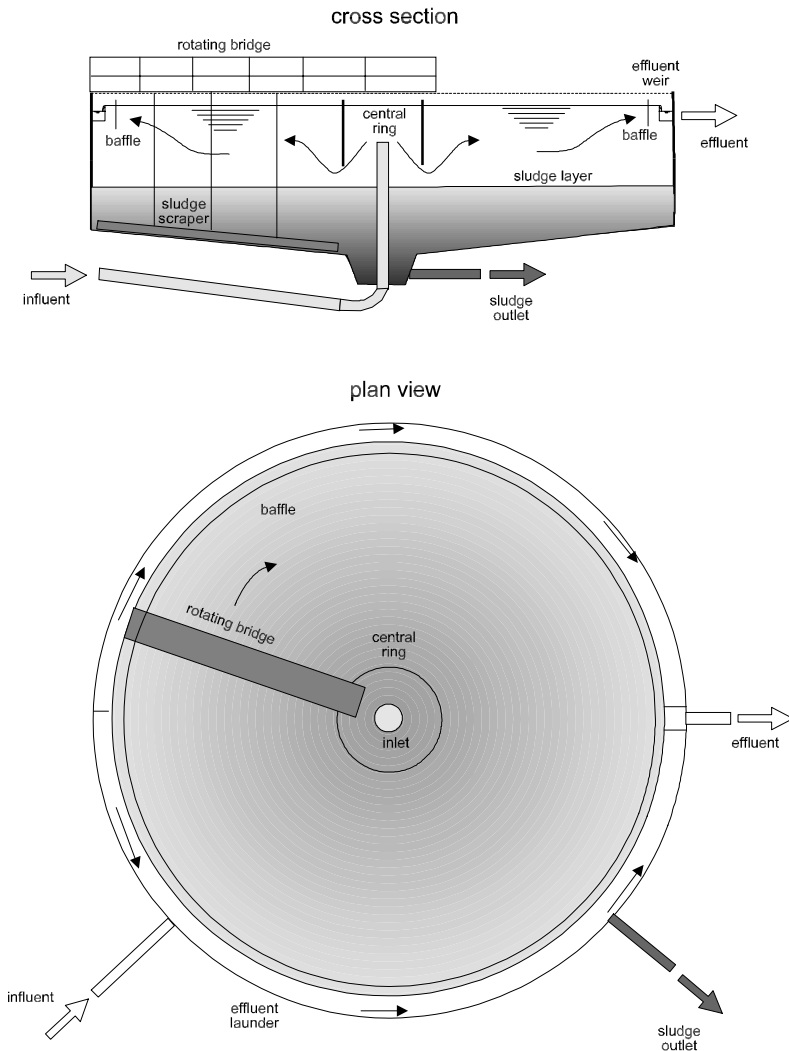

Figure 33.2. Schematics of a circular secondary sedimentation tank (section and plan view)

It is important to note that the hydraulic loading rate (HLR) is based only on the influent flow to the plant (Q), and not on the total influent flow to the sedimentation tank ($Q + Q_r$). This is because only the Q flow has an upward component, leaving through the weirs on the top (the return sludge flow Q_r has a downward direction, leaving through the bottom of the sedimentation tank). The

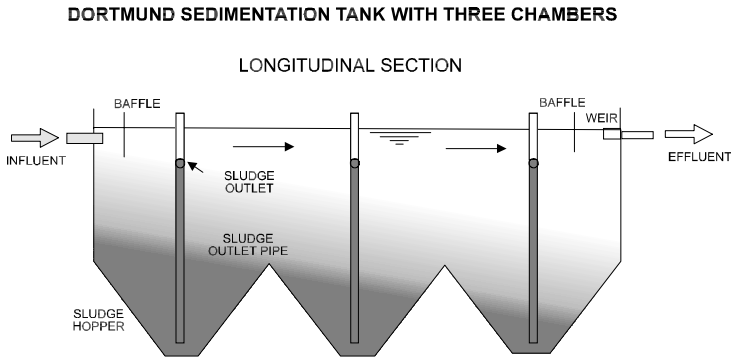

Figure 33.3. Dortmund-type tank, with high bottom slope and no sludge removal mechanism

Table 33.1. Hydraulic and solids loading rates for secondary sedimentation tanks

System	Hydraulic loading rate ($\text{m}^3/\text{m}^2\cdot\text{hour}$)		Solids loading rate ($\text{kg}/\text{m}^2\cdot\text{hour}$)		Reference
	Average Q	Maximum Q	Average Q	Maximum Q	
Conventional activated sludge	0.67–1.33	1.70–2.00	4.0–6.0	10.0	(1)
	0.67–1.20	1.70–2.70	4.0–6.0	–	(2)
Extended aeration	0.33–0.67	1.00–1.33	1.0–5.0	7.0	(1)

Ref: (1) Metcalf and Eddy (1991); (2) WEF/ASCE (1992)

upflow component is important because if the upward velocity of the liquid is higher than the settling velocity of the solids, the latter will not be able to go to the bottom of the sedimentation tank, thus leaving with the final effluent.

In terms of the solids loading rate, it is important that the load of solids applied per unit area is not higher than the limiting solid flux. In this case, the load applied is the actual influent load to the sedimentation tank, that is, $(Q + Q_r) \cdot X$.

These aspects are covered by the limiting solids flux theory, described in Chapter 10. If data on the settleability of the sludge under study are available, the limiting flux theory can be used for the design of the secondary sedimentation tanks, as demonstrated in Chapter 10. In this case, the solids loading rate (SLR) to be used is equal to the limiting solids flux. A simplified approach using concepts of the solids flux theory is described in Section 33.2.2.

Surface loading rates based on the designers' experience are usually used. Table 33.1 presents typical loading rate values according to some traditional references (Metcalf and Eddy, 1991; WEF/ASCE, 1992).

Example 33.1 presents the calculation of the area required for the secondary sedimentation tanks, based on the concepts of the hydraulic and solids loading rates. The complete design of the secondary sedimentation tank is covered in the example given in Chapter 34.

Example 33.1

Calculate the area required for the secondary sedimentation tanks of a conventional activated sludge plant, which has the following data (same data as those for the design example of Chapter 34, for conventional activated sludge):

- average influent flow: $Q = 9,820 \text{ m}^3/\text{d}$
- maximum influent flow: $Q_{\max} = 19,212 \text{ m}^3/\text{d}$
- average return sludge flow: $Q_r = 9,820 \text{ m}^3/\text{d}$
- concentration of suspended solids in the reactor: $\text{MLSS} = 3,896 \text{ g}/\text{m}^3$

Solution:

(a) Express the flows in m^3/hour

$$Q = 9,820/24 = 409 \text{ m}^3/\text{hour}$$

$$Q_{\max} = 19,212/24 = 801 \text{ m}^3/\text{hour}$$

$$Q_r = 9,820/24 = 409 \text{ m}^3/\text{hour}$$

(b) Calculate the surface area based on the hydraulic loading rate

From Table 33.1, adopt the following hydraulic loading rate values:

$$\text{For } Q_{\text{av}} \rightarrow \text{HLR} = 0.80 \text{ m}^3/\text{m}^2 \cdot \text{hour}$$

$$\text{For } Q_{\max} \rightarrow \text{HLR} = 1.80 \text{ m}^3/\text{m}^2 \cdot \text{hour}$$

The required surface area is given by:

$$\text{For } Q_{\text{av}} \rightarrow A = Q/\text{HLR} = 409/0.8 = 511 \text{ m}^2$$

$$\text{For } Q_{\max} \rightarrow A = Q_{\max}/\text{HLR} = 801/1.80 = 445 \text{ m}^2$$

(c) Calculate the surface area based on the solids loading rate

The influent suspended solids load to the secondary sedimentation tank is:

$$\text{For } Q_{\text{av}} \rightarrow (Q + Q_r) \cdot X = (409 + 409) \times 3,896/1,000 = 3,187 \text{ kgSS}/\text{hour}$$

$$\text{For } Q_{\max} \rightarrow (Q_{\max} + Q_r) \cdot X = (801 + 409) \times 3,896/1,000 = 4,714 \text{ kgSS}/\text{hour}$$

From Table 33.1, adopt the following solids loading rate values:

$$\text{For } Q_{\text{av}} \rightarrow \text{SLR} = 5.0 \text{ kgSS}/\text{m}^2 \cdot \text{hour}$$

$$\text{For } Q_{\max} \rightarrow \text{SLR} = 10.0 \text{ kgSS}/\text{m}^2 \cdot \text{hour}$$

The required surface area is given by:

$$\text{For } Q_{\text{av}} \rightarrow A = (Q + Q_r) \cdot X / (1,000 \cdot \text{SLR}) = 3,187/5.0 = 637 \text{ m}^2$$

$$\text{For } Q_{\max} \rightarrow A = (Q_{\max} + Q_r) \cdot X / (1,000 \cdot \text{SLR}) = 4,714/10.0 = 471 \text{ m}^2$$

Example 33.1 (Continued)**(d) Surface area to be adopted**

The surface area to be adopted for the secondary sedimentation tanks should correspond to the largest value among the four values obtained (511 m², 445 m², 637 m² and 471 m²). Therefore, the area required for the secondary sedimentation tanks is:

$$A = 637 \text{ m}^2$$

It is to be noted that in this example the most restrictive criterion, that is, the criterion that led to the largest required area, was that of the solids loading rate for the average flow. This conclusion reinforces the notion that the secondary sedimentation tanks should be designed by taking into consideration the solids loading rate, and not just the hydraulic loading rate, as is usual in the design of other sedimentation tanks.

Apparently conservative loading rate values were adopted in this example, but the importance of the adequate performance of the secondary sedimentation tanks justifies that.

33.2.2 Determination of the surface area according to loading rates based on a simplified approach to the solids flux theory

As commented in Chapter 10, the solids flux theory is an important tool for the design and control of secondary sedimentation tanks. However, its use is often difficult due to *a priori* lack of knowledge of the parameters characterising the sludge settleability (v_o and K), unless the design is intended for expansion of an already existing plant, with an already known sludge (Section 10.5.2 presents the concept of the coefficients v_o and K , used for estimation of the settling velocity of the interface, v).

Aiming at expanding the use of the limiting solids flux theory, several authors (White, 1976; Johnstone *et al.*, 1979; Tuntoolavest and Grady, 1982; Koopman and Cadee, 1983; Pitman, 1984; Daigger and Roper, 1985; Ekama and Marais, 1986; Wahlberg and Keinath, 1988, 1995; van Haandel *et al.*, 1988; von Sperling, 1990; Daigger, 1995) tried to express the interface settling velocity according to easily determinable or assumable variables, such as the sludge volume index (SVI and its variants). Once the sludge settling velocity is estimated, the limiting flux theory can be easily employed for design and operation. However, each author used a different form to express the sludge volume index, thus making the calculation of unified values more difficult.

By using the methodology proposed by von Sperling (1994b), Fróes (1996) conjugated the data obtained by the authors above and presented a unique formulation,

Table 33.2. Typical SVI ranges and values (average), according to its four variants and five settleability ranges

Settleability	Range of sludge volume index values (mL/g)							
	SVI		DSVI		SSVI		SSVI _{3,5}	
	Range	Typical	Range	Typical	Range	Typical	Range	Typical
<i>Very good</i>	0–50	45	0–45	40	0–50	45	0–40	35
<i>Good</i>	50–100	75	45–95	70	50–80	65	40–80	60
<i>Fair</i>	100–200	150	95–165	130	80–140	110	80–100	90
<i>Poor</i>	200–300	250	165–215	190	140–200	170	100–120	110
<i>Very poor</i>	300–400	350	215–305	260	200–260	230	120–160	140

Notes: The ranges were established based on the analysis of the various references mentioned. The typical values were considered, in most of the cases, as the mean value in the range.

Table 33.3. Values of the coefficients v_0 , K, m and n, for each settleability range

Settleability	Settling velocity (m/hour) $v = v_0 \cdot e^{-K \cdot C}$		Limiting flux (kg/m ² ·hour) $G_L = m \cdot (Q_r/A)^n$	
	v_0 (m/hour)	K (m ³ /kg)	m	n
<i>Very good</i>	10.0	0.27	14.79	0.64
<i>Good</i>	9.0	0.35	11.77	0.70
<i>Fair</i>	8.6	0.50	8.41	0.72
<i>Poor</i>	6.2	0.67	6.26	0.69
<i>Very poor</i>	5.6	0.73	5.37	0.69

v : Interface settling velocity (m/hour)

C : Influent SS concentration to the sedimentation tank (MLSS) (kgSS/m³)

G_L : Limiting solid flux (kg/m²·hour)

Q_r : Return sludge flow (approximately equal to the underflow from the sedimentation tank) (m³/hour)

A : Surface area of the sedimentation tanks (m²)

v_0 , K, m, n: Coefficients

based on settleability ranges. The proposition made by von Sperling and Fróes (1998, 1999) is described in this section.

Table 33.2 presents the typical settleability ranges, according to the several variants of the sludge volume index test (see Section 10.5.4 for an explanation of the types of the SVI test). The interpretation of Table 33.2 is that the average or *fair* settleability can be characterised by a sludge with a SVI of 150 mL/g, a DSVI of 130 mL/g, a SSVI of 110 mL/g and a SSVI_{3,5} of 90 mL/g. This unification, according to the settleability ranges, forms a common base, from which the values obtained by the several authors mentioned above can be integrated.

The average v_0 and K values obtained by the various authors were calculated for each settleability range (*very good* to *very poor*) (see Table 33.3). As a whole, data presented in 17 publications were used, representing dozens of activated sludge plants operating in real scale. Based on the v_0 and K values obtained by each author, the limiting solids flux as a function of Q_r/A was calculated, according

to the methodology presented in Section 10.5. After that, the relation between the limiting solids flux (G_L) and Q_r/A was determined by regression analysis, for each author and for each settleability range, according to the multiplicative equation $G_L = m \cdot (Q_r/A)^n$. After that, the average m and n values obtained by the various authors were calculated for each settleability range, which are presented in Table 33.3.

Knowing the v_o , K , m and n values for each settleability range, the design can be done according to the criteria presented below. From the unification proposed, there is no need to work with the various authors' values and with different sludge volume indices, but only with the settleability ranges estimated for the sludge. Thus, the area required for the sedimentation tanks can be calculated using the principles of the solids flux theory just by knowing the concentration of MLSS in the reactor (C), the influent flow (Q) and the return sludge flow (Q_r), and by assuming the sludge settleability (settleability range).

(a) Design principles

In order not to lose solids in the effluent, the secondary sedimentation tank should not be overloaded in terms of clarification and thickening (Keinath, 1981). This means that the following two criteria need to be met (see Chapter 10):

- *sedimentation tank should not be overloaded in terms of clarification:* the hydraulic loading rate should not exceed the sludge settling velocity

$$Q/A \leq v \quad (33.1)$$

$$Q/A \leq v_o \cdot e^{-K \cdot C} \quad (33.2)$$

- *sedimentation tank should not be overloaded in terms of thickening:* the applied solids flux should not exceed the limiting solids flux

$$G_a \leq G_L \quad (33.3)$$

$$(Q + Q_r) \cdot C_o/A \leq m \cdot (Q_r/A)^n \quad (33.4)$$

where:

Q = influent flow to the plant (m^3/hour)

Q_r = return sludge flow (m^3/hour)

v = settling velocity of the interface at the concentration C (m/hour)

v_o = coefficient, expressing the settling velocity of the interface at a concentration $C = 0$ (m/hour)

K = sedimentation coefficient (m^3/kg)

G_a = applied solids flux ($\text{kg}/m^2 \cdot \text{hour}$)

G_L = limiting solids flux (= maximum allowable solids loading rate) ($\text{kg}/m^2 \cdot \text{hour}$)

C_o = concentration of influent solids to the secondary sedimentation tank
 (=MLSS) (kg/m^3)

A = surface area required for the sedimentation tanks (m^2)

(b) Design for clarification

Considering the concentration of influent suspended solids to the sedimentation tank (C_o) as equal to MLSS, the settling velocity can be obtained from the equation $v = v_o \cdot e^{-K \cdot C}$, with v_o and K values obtained from Table 33.3. Thus, the hydraulic loading rate should be equal to or lower than the value of v calculated (Equation 33.2). Figure 33.4 presents the resulting curves of hydraulic loading rates for the different sludge settleabilities and for different MLSS concentrations.

(c) Design for thickening

After meeting the clarification criteria, in which an adequate value was adopted for the hydraulic loading rate (Q/A), the SLR can be established. The first step is to select a value for the return sludge ratio $R(Q_r/Q)$. In other words, Q_r/A should be equal to $R \cdot Q/A$. Using the coefficient values given in Table 33.3, and adopting the concept of Equation 33.4, the allowable maximum solids rate should be equal to:

$$\text{SLR} = m \cdot (R \cdot Q/A)^n \tag{33.5}$$

In terms of design, the SLR is adopted as being equal to the limiting flux G_L . Since the Q/A value is itself a function of the MLSS concentration (C_o), to meet

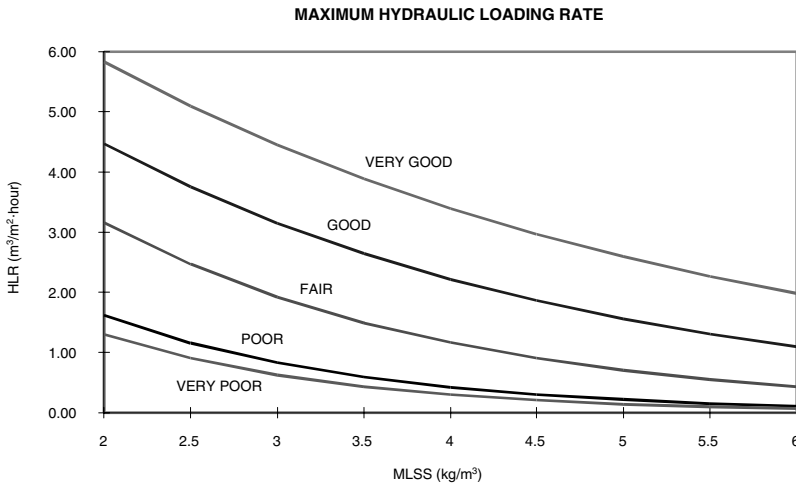

Figure 33.4. Hydraulic loading rates (HLR) for the design of secondary sedimentation tanks, as a function of different sludge settleabilities and MLSS concentrations

the clarification criteria, the maximum solid loading rate can also be expressed as presented in Equation 33.6, where Q/A was replaced by the settling velocity given on the right – hand side of Equation 33.2.

$$SLR = m \cdot [R \cdot v_o e^{(-K \cdot C_o)}]^n \tag{33.6}$$

By knowing the intervening coefficients (v_o , K , m , n), the maximum solid loading rate can be easily determined (Equation 33.6). In these conditions, the **clarification and thickening criteria are simultaneously met**. It should be remembered that the four coefficients are functions of the sludge settleability (*very good, good, fair, poor* and *very poor*), as expressed in Table 33.3.

Figure 33.5 presents the curves of the maximum solid loading rates for the different sludge settleabilities (*very good, good, fair, poor* and *very poor*), MLSS concentrations (C_o), and return sludge ratios ($= Q_r/Q$). The graph clearly shows the essential relations: the better the sludge settleability, or the lower the MLSS concentration, or still the higher the return sludge ratio, then the higher the allowable solid loading rate and, consequently, the smaller the required surface area.

After obtaining the value for the maximum allowable G_L , the required area A can be finally calculated using

$$A = \frac{(Q+Q_r) \cdot C_o}{SLR} \tag{33.7}$$

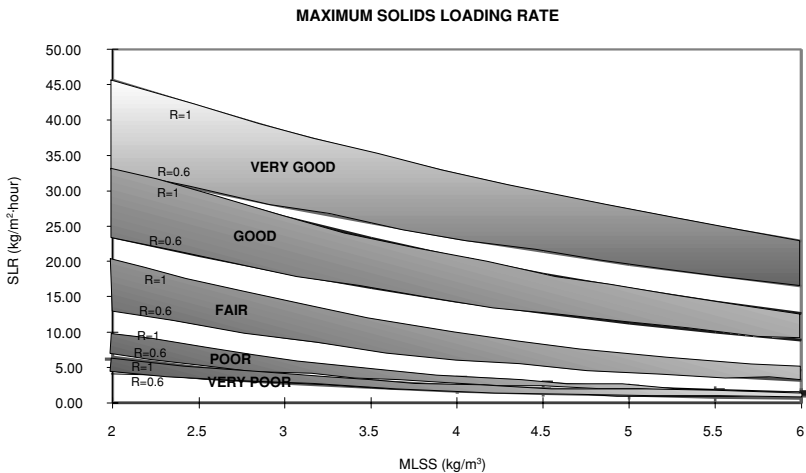

Figure 33.5. Solid loading rate (SLR) for the design of secondary sedimentation tanks, as a function of different sludge settleabilities, return sludge ratios R and MLSS concentrations. In each range, the highest value corresponds to $R = 1.0$, while the lowest value corresponds to $R = 0.6$

For design purposes, the sludge settleability should be considered as **fair** or **poor**, depending on the desirable safety degree. An intermediate **fair–poor** range can also be adopted, for which the curve and coefficient values can then be interpolated.

(d) Summary of the proposed approach

The main advantage of the proposed methodology is that of working with the integrated data from 17 publications, representing a database of dozens of activated sludge plants operating in full scale worldwide.

The proposed methodology can also be used by means of Table 33.4, which represents a synthesis of Figure 33.5 and Equation 33.6, meeting simultaneously the clarification and thickening criteria. It should be emphasised that Table 33.4 can be used for both design and control of secondary sedimentation tanks (under the steady-state assumption).

Figures 33.6 and 33.7 present the curves from Figures 33.4 and 33.5, but only for the fair and poor settleability ranges, usually of higher interest for design and operation. Both figures also present the design ranges according to the conventional criteria covered in Section 33.2.1. For the two main activated sludge variants, the following MLSS ranges are considered typical: (a) conventional activated sludge: MLSS from 2.5 to 4.5 g/L and (b) extended aeration: MLSS from 3.5 to 5.5 g/L.

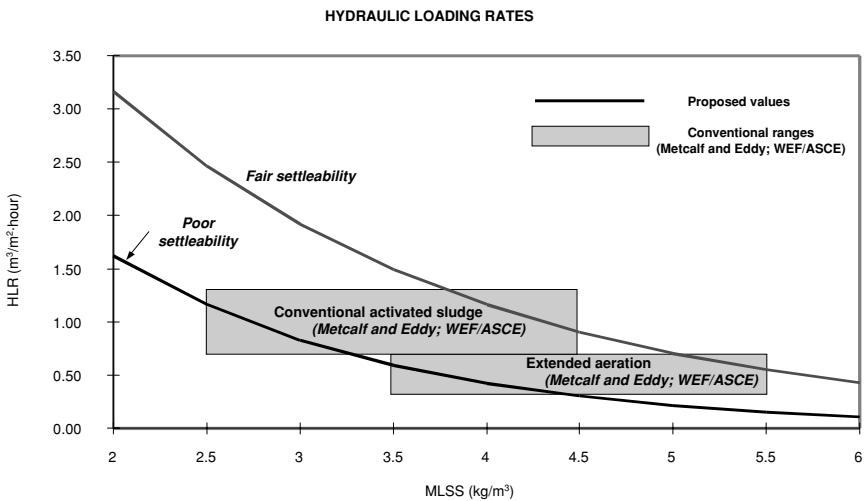

Figure 33.6. Comparison between the proposed HLR and those from traditional methods (Metcalf and Eddy, 1991; WEF/ASCE, 1992)

Table 33.4. Maximum values for the HLR and SLR in secondary sedimentation tanks, as a function of MLSS and R ($=Q_r/Q$)

Very good settleability						
MLSS (mg/L)	HLR = Q/A (m ³ /m ² ·hour)	SLR = (Q + Q _r)·MLSS/(1,000·A)(kgSS/m ² ·hour)				
		R = 0.4	R = 0.6	R = 0.8	R = 1.0	R = 1.2
2,000	5.83	25.42	32.95	39.61	45.70	51.35
2,500	5.09	23.32	30.23	36.34	41.91	47.10
3,000	4.45	21.39	27.72	33.33	38.44	43.20
3,500	3.89	19.62	25.43	30.57	35.26	39.63
4,000	3.40	17.99	23.32	28.04	32.34	36.35
4,500	2.97	16.50	21.39	25.72	29.67	33.34
5,000	2.59	15.14	19.62	23.59	27.21	30.58
5,500	2.27	13.88	18.00	21.64	24.96	28.05
6,000	1.98	12.74	16.51	19.85	22.89	25.73
Good settleability						
MLSS (mg/L)	HLR = Q/A (m ³ /m ² ·hour)	SLR = (Q + Q _r)·MLSS/(1,000·A)(kgSS/m ² ·hour)				
		R = 0.4	R = 0.6	R = 0.8	R = 1.0	R = 1.2
2,000	4.47	17.68	23.48	28.71	33.57	38.14
2,500	3.75	15.64	20.77	25.40	29.70	33.74
3,000	3.15	13.84	18.38	22.48	26.27	29.85
3,500	2.64	12.24	16.26	19.88	23.25	26.41
4,000	2.22	10.83	14.38	17.59	20.57	23.36
4,500	1.86	9.58	12.72	15.56	18.19	20.67
5,000	1.56	8.48	11.26	13.77	16.10	18.29
5,500	1.31	7.50	9.96	12.18	14.24	16.18
6,000	1.10	6.63	8.81	10.78	12.60	14.31
Fair settleability						
MLSS (mg/L)	HLR = Q/A (m ³ /m ² ·hour)	SLR = (Q + Q _r)·MLSS/(1,000·A)(kgSS/m ² ·hour)				
		R = 0.4	R = 0.6	R = 0.8	R = 1.0	R = 1.2
2,000	3.16	9.96	13.34	16.41	19.27	21.98
2,500	2.46	8.32	11.14	13.71	16.10	18.36
3,000	1.92	6.95	9.31	11.45	13.45	15.33
3,500	1.49	5.81	7.77	9.56	11.23	12.81
4,000	1.16	4.85	6.49	7.99	9.38	10.70
4,500	0.91	4.05	5.42	6.67	7.84	8.93
5,000	0.71	3.38	4.53	5.57	6.54	7.46
5,500	0.55	2.83	3.78	4.66	5.47	6.23
6,000	0.43	2.36	3.16	3.89	4.57	5.21
Poor settleability						
MLSS (mg/L)	HLR = Q/A (m ³ /m ² ·hour)	SLR = (Q + Q _r)·MLSS/(1,000·A)(kgSS/m ² ·hour)				
		R = 0.4	R = 0.6	R = 0.8	R = 1.0	R = 1.2
2,000	1.62	4.65	6.15	7.50	8.75	9.92
2,500	1.16	3.69	4.88	5.95	6.94	7.87
3,000	0.83	2.93	3.87	4.72	5.51	6.25
3,500	0.59	2.32	3.07	3.75	4.37	4.96
4,000	0.43	1.84	2.44	2.97	3.47	3.93
4,500	0.30	1.46	1.94	2.36	2.75	3.12
5,000	0.22	1.16	1.54	1.87	2.19	2.48
5,500	0.16	0.92	1.22	1.49	1.73	1.97
6,000	0.11	0.73	0.97	1.18	1.38	1.56

Table 33.4 (Continued)

		Very poor settleability				
MLSS (mg/L)	HLR = Q/A (m ³ /m ² ·hour)	SLR = (Q + Q _r)·MLSS/(1,000·A)(kgSS/m ² ·hour)				
		R = 0.4	R = 0.6	R = 0.8	R = 1.0	R = 1.2
2,000	1.30	3.42	4.53	5.52	6.44	7.30
2,500	0.90	2.66	3.52	4.29	5.00	5.68
3,000	0.63	2.07	2.73	3.33	3.89	4.41
3,500	0.44	1.61	2.13	2.59	3.02	3.43
4,000	0.30	1.25	1.65	2.02	2.35	2.67
4,500	0.21	0.97	1.28	1.57	1.83	2.07
5,000	0.15	0.75	1.00	1.22	1.42	1.61
5,500	0.10	0.59	0.78	0.95	1.10	1.25
6,000	0.07	0.46	0.60	0.74	0.86	0.97

MLSS (mg/L); Q (m³/hour); Q_r (m³/hour); A (m²); HLR = v₀·e^(-KMLSS/1,000); SLR = m·(HLR·R)ⁿ
 Classification of the settleability: see Table 33.2; v₀, K, m, n values: see Table 33.3

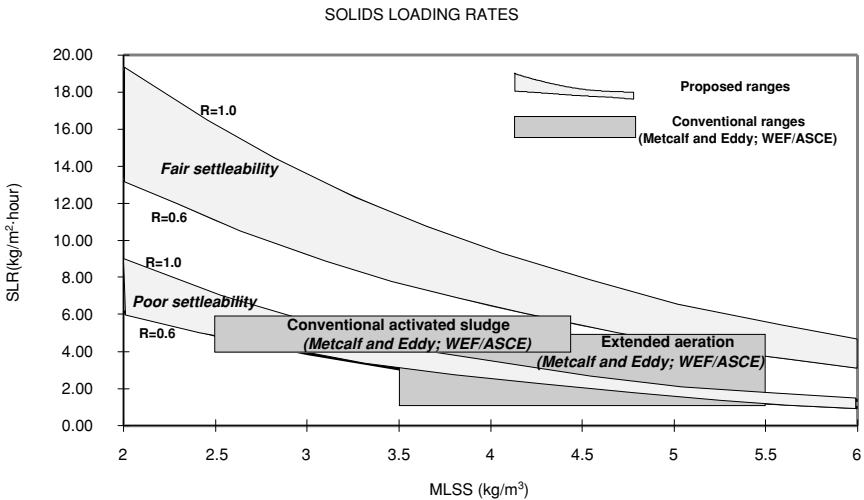

Figure 33.7. Comparison between the proposed SLR and those from traditional methods (Metcalf and Eddy, 1991; WEF/ASCE, 1992)

The analysis of the figures leads to the following points:

- The conventional loading rates are situated between the *fair* and *poor* settleability ranges.
- The extended aeration, which operates with a higher solid concentration, requires more conservative loading rates.
- The influence of the return sludge ratio, not taken into consideration in the traditional approach, can be clearly noticed.
- The proposed method allows a continuous solution for any MLSS and R values and settleability ranges, not leading to stepwise solutions, such as those from the conventional loading-rate methods.

Table 33.5 presents a more detailed version of Table 33.4, including more values of the MLSS concentration and return sludge ratio R. Its presentation form is different, clearer and simpler for design and operation (see Examples 33.2 and 33.3). The table presents, for each MLSS and R pair, the maximum Q/A values that meet the clarification and thickening criteria (hydraulic and solids loading rates). The lowest Q/A value found should be adopted for the design. Only the *fair*, *poor* and *very poor* settleability ranges are presented, since they are more important for design and operational purposes.

The maximum Q/A values required to meet the **clarification criteria** are given by Equation 33.2, already presented:

$$\boxed{Q/A = v_o \cdot e^{-K \cdot C_o}} \quad (33.2)$$

The maximum Q/A values required to meet the **thickening criteria** are obtained from the following calculation:

$$SLR = \frac{(Q + Q_r) \cdot C_o}{A} = \frac{(Q + R \cdot Q) \cdot C_o}{A} = \frac{Q}{A} \cdot (R + 1) \cdot C_o \quad (33.8)$$

$$Q/A = \frac{SLR}{(R + 1) \cdot C_o} \quad (33.9)$$

$$\boxed{Q/A = \frac{m \cdot [R \cdot v_o \cdot e^{(-K \cdot C_o)}]^n}{(R + 1) \cdot C_o}} \quad (33.10)$$

Figure 33.8 presents the Q/A values that *meet simultaneously the clarification and thickening criteria* (maximum HLR and SLR), according to the concepts above (Equations 33.2 and 33.10), for the *fair* and *poor* settleability ranges and for several MLSS (2,000 to 6,000 mg/L) and R (0.6, 0.8 and 1.0) values. There are three curves for each settleability range, each one representing a return sludge ratio R. Where the three curves are merged, the clarification criteria (Equation 33.2) are more restrictive, controlling the process, and the return sludge ratio has no influence. Where the three curves are separated, the thickening criteria are more demanding, controlling the process. It is noticed that the HLR values mentioned in literature (Table 33.1) are located in a range between the *fair* and *poor* settleabilities.

In terms of design, by knowing the influent flow and by adopting reasonable MLSS and R values and settleability characteristics (*fair* or *poor*), the required surface area can be calculated by means of Equations 33.2 and 33.10, Table 33.5, or even Figure 33.8. For a long-term operational control (not for daily control, which requires a dynamic model of the sedimentation tanks), different combinations of MLSS and R can be tried, by adopting the appropriate settleability range, to obtain the Q/A value corresponding to that existing in the plant.

Table 33.5. Q/A values ($\text{m}^3/\text{m}^2 \cdot \text{hour}$) that meet the clarification and thickening criteria (HLR and SLR), for several MLSS and R values, and for different settleability ranges

MLSS (mg/L)	Q/A for clarification ($\text{m}^3/\text{m}^2 \cdot \text{hour}$)	Fair settleability									
		Q/A for thickening ($\text{m}^3/\text{m}^2 \cdot \text{hour}$)									
		R = 0.4	R = 0.5	R = 0.6	R = 0.7	R = 0.8	R = 0.9	R = 1.0	R = 1.1	R = 1.2	
2,000	3.16	3.56	3.90	4.17	4.38	4.56	4.70	4.82	4.91	4.99	
2,200	2.86	3.01	3.30	3.53	3.71	3.86	3.98	4.08	4.16	4.23	
2,400	2.59	2.57	2.81	3.01	3.16	3.29	3.39	3.48	3.55	3.60	
2,600	2.34	2.21	2.42	2.58	2.72	2.83	2.91	2.99	3.05	3.10	
2,800	2.12	1.91	2.09	2.23	2.35	2.44	2.52	2.58	2.63	2.67	
3,000	1.92	1.66	1.81	1.94	2.04	2.12	2.19	2.24	2.29	2.32	
3,200	1.74	1.44	1.58	1.69	1.78	1.85	1.91	1.96	1.99	2.03	
3,400	1.57	1.26	1.39	1.48	1.56	1.62	1.67	1.71	1.75	1.77	
3,600	1.42	1.11	1.22	1.30	1.37	1.42	1.47	1.50	1.53	1.56	
3,800	1.29	0.98	1.07	1.15	1.21	1.26	1.29	1.33	1.35	1.38	
4,000	1.16	0.87	0.95	1.01	1.07	1.11	1.14	1.17	1.20	1.22	
4,200	1.05	0.77	0.84	0.90	0.95	0.98	1.01	1.04	1.06	1.08	
4,400	0.95	0.68	0.75	0.80	0.84	0.87	0.90	0.92	0.94	0.96	
4,600	0.86	0.61	0.67	0.71	0.75	0.78	0.80	0.82	0.84	0.85	
4,800	0.78	0.54	0.59	0.63	0.67	0.69	0.71	0.73	0.75	0.76	
5,000	0.71	0.48	0.53	0.57	0.60	0.62	0.64	0.65	0.67	0.68	
5,200	0.64	0.43	0.47	0.51	0.53	0.55	0.57	0.59	0.60	0.61	
5,400	0.58	0.39	0.42	0.45	0.48	0.50	0.51	0.52	0.54	0.54	
5,600	0.52	0.35	0.38	0.41	0.43	0.45	0.46	0.47	0.48	0.49	
5,800	0.47	0.31	0.34	0.37	0.38	0.40	0.41	0.42	0.43	0.44	
6,000	0.43	0.28	0.31	0.33	0.35	0.36	0.37	0.38	0.39	0.39	

(Continued)

Table 33.5 (Continued)

		Poor settleability									
MLSS (mg/L)	Q/A for clarification (m ³ /m ² ·hour)	Q/A for thickening (m ³ /m ² ·hour)									
		R = 0.4	R = 0.5	R = 0.6	R = 0.7	R = 0.8	R = 0.9	R = 1.0	R = 1.1	R = 1.2	
2,000	1.62	1.66	1.81	1.92	2.01	2.08	2.14	2.19	2.22	2.25	
2,200	1.42	1.38	1.59	1.59	1.67	1.73	1.77	1.81	1.84	1.87	
2,400	1.24	1.15	1.33	1.33	1.39	1.44	1.48	1.51	1.54	1.56	
2,600	1.09	0.97	1.12	1.12	1.17	1.21	1.25	1.27	1.30	1.31	
2,800	0.95	0.82	0.95	0.95	0.99	1.03	1.06	1.08	1.10	1.11	
3,000	0.83	0.70	0.81	0.81	0.84	0.87	0.90	0.92	0.93	0.95	
3,200	0.73	0.60	0.69	0.69	0.72	0.75	0.77	0.78	0.80	0.81	
3,400	0.64	0.51	0.59	0.59	0.62	0.64	0.66	0.67	0.68	0.69	
3,600	0.56	0.44	0.51	0.51	0.53	0.55	0.57	0.58	0.59	0.60	
3,800	0.49	0.38	0.44	0.44	0.46	0.48	0.49	0.50	0.51	0.52	
4,000	0.43	0.33	0.38	0.38	0.40	0.41	0.42	0.43	0.44	0.45	
4,200	0.37	0.29	0.31	0.33	0.35	0.36	0.37	0.38	0.38	0.39	
4,400	0.33	0.25	0.27	0.29	0.30	0.31	0.32	0.33	0.33	0.34	
4,600	0.28	0.22	0.24	0.25	0.26	0.27	0.28	0.29	0.29	0.29	
4,800	0.25	0.19	0.21	0.22	0.23	0.24	0.24	0.25	0.25	0.26	
5,000	0.22	0.17	0.18	0.19	0.20	0.21	0.21	0.22	0.22	0.23	
5,200	0.19	0.15	0.16	0.17	0.18	0.18	0.19	0.19	0.19	0.20	
5,400	0.17	0.13	0.14	0.15	0.15	0.16	0.16	0.17	0.17	0.17	
5,600	0.15	0.11	0.12	0.13	0.14	0.14	0.14	0.15	0.15	0.15	
5,800	0.13	0.10	0.11	0.11	0.12	0.12	0.13	0.13	0.13	0.13	
6,000	0.11	0.09	0.09	0.10	0.11	0.11	0.11	0.11	0.12	0.12	

Very poor settleability

MLSS (mg/L)	Q/A for clarification (m ³ /m ² ·hour)	Q/A for thickening (m ³ /m ² ·hour)									
		R = 0.4	R = 0.5	R = 0.6	R = 0.7	R = 0.8	R = 0.9	R = 1.0	R = 1.1	R = 1.2	
2,000	1.30	1.22	1.33	1.41	1.48	1.53	1.58	1.61	1.64	1.66	
2,200	1.12	1.00	1.16	1.22	1.29	1.32	1.36	1.39	1.42	1.45	
2,400	0.97	0.83	0.91	0.96	1.01	1.04	1.07	1.10	1.12	1.13	
2,600	0.84	0.69	0.76	0.80	0.84	0.87	0.90	0.92	0.93	0.94	
2,800	0.73	0.58	0.63	0.68	0.71	0.73	0.75	0.77	0.78	0.79	
3,000	0.63	0.49	0.54	0.57	0.60	0.62	0.63	0.65	0.66	0.67	
3,200	0.54	0.42	0.45	0.48	0.51	0.52	0.54	0.55	0.56	0.57	
3,400	0.47	0.36	0.39	0.41	0.43	0.45	0.46	0.47	0.48	0.48	
3,600	0.40	0.30	0.33	0.35	0.37	0.38	0.39	0.40	0.41	0.41	
3,800	0.35	0.26	0.28	0.30	0.31	0.33	0.33	0.34	0.35	0.35	
4,000	0.30	0.22	0.24	0.26	0.27	0.28	0.29	0.29	0.30	0.30	
4,200	0.26	0.19	0.21	0.22	0.23	0.24	0.25	0.25	0.26	0.26	
4,400	0.23	0.17	0.18	0.19	0.20	0.21	0.21	0.22	0.22	0.23	
4,600	0.19	0.14	0.16	0.17	0.17	0.18	0.18	0.19	0.19	0.19	
4,800	0.17	0.12	0.14	0.14	0.15	0.16	0.16	0.16	0.17	0.17	
5,000	0.15	0.11	0.12	0.12	0.13	0.14	0.14	0.14	0.14	0.15	
5,200	0.13	0.09	0.10	0.11	0.11	0.12	0.12	0.12	0.13	0.13	
5,400	0.11	0.08	0.09	0.09	0.10	0.10	0.11	0.11	0.11	0.11	
5,600	0.09	0.07	0.08	0.08	0.09	0.09	0.09	0.09	0.10	0.10	
5,800	0.08	0.06	0.07	0.07	0.08	0.08	0.08	0.08	0.08	0.08	
6,000	0.07	0.05	0.06	0.06	0.07	0.07	0.07	0.07	0.07	0.07	

For each MLSS and R values, compare Q/A for clarification with Q/A for thickening, and adopt the lowest value
 Calculation of the Q/A values: Clarification (Equation 33.2); thickening (Equation 33.10)
 Classification of the settleability: See Table 33.2

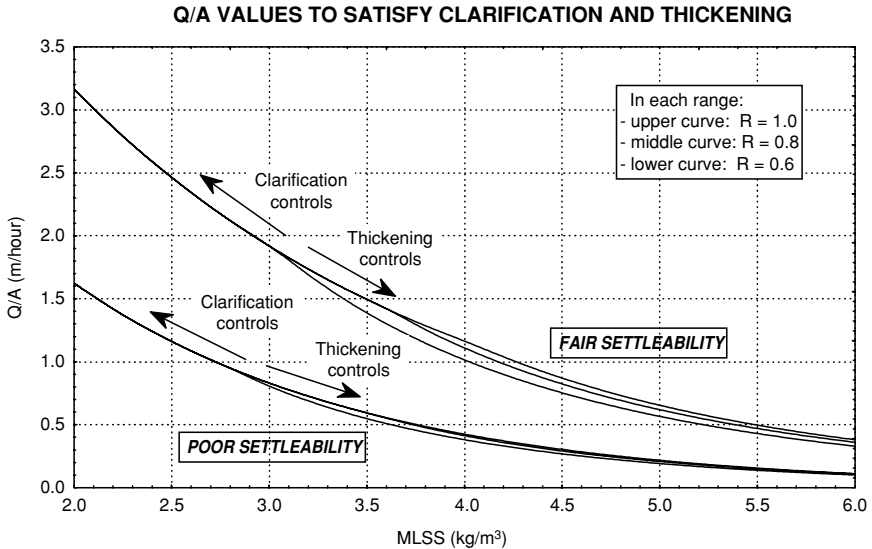

Figure 33.8. Q/A values to meet simultaneously the clarification and thickening criteria (HLR and SLR), for the *fair* and *poor* settleability ranges and for several MLSS and R values

Example 33.2

Using the methodology presented in this section, calculate the surface area required for the secondary sedimentation tanks of a conventional activated sludge plant. Use the same data as those in Example 33.1 and the design example in Chapter 34:

- average influent flow: $Q = 9,820 \text{ m}^3/\text{d}$
- average return sludge flow: $Q_r = 9,820 \text{ m}^3/\text{d}$
- mixed liquor suspended solids concentration: $\text{MLSS} = 3,896 \text{ g}/\text{m}^3$

Solution:

(a) Express the flows in m³/hour

$$Q = 9,820/24 = 409 \text{ m}^3/\text{hour}$$

$$Q_r = 9,820/24 = 409 \text{ m}^3/\text{hour}$$

The return sludge ratio R is equal to $Q_r/Q = 409/409 = 1.0$

(b) Calculation of the surface area based on the hydraulic and solids loading rates

Assume a *poor* sludge settleability.

$$\text{With MLSS} = 3,896 \text{ mg}/\text{L} \rightarrow C_o = 3.896 \text{ kg}/\text{m}^3.$$

Example 33.2 (Continued)

Using the v_o , K , m and n values of Table 33.3: $v_o = 6.2$ m/hour; $K = 0.67$ m³/kg; $m = 6.26$; $n = 0.69$

Clarification requirements (Equation 33.2):

$$\text{HLR} = v_o \cdot e^{-K \cdot C} = 6.2 \cdot e^{-0.67 \times 3.896} = 0.456 \text{ m/hour}$$

The required area is given by:

$$A = \frac{Q}{\text{HLR}} = \frac{409}{0.456} = 897 \text{ m}^2$$

Note: the hydraulic loading rate value of 0.456 m/hour can approximately be also obtained by interpolation in Tables 33.4 and 33.5 (*poor* settleability and $\text{MLSS} = 3,896$ mg/L).

Thickening requirements (Equation 33.6):

$$\begin{aligned} \text{SLR} &= m \cdot [R \cdot v_o \cdot e^{-(K \cdot C_o)}]^n = 6.26 \cdot [1.0 \times 6.2 \cdot e^{-(0.67 \times 3.896)}]^{0.69} \\ &= 3.640 \text{ kgSS/m}^2 \cdot \text{hour} \end{aligned}$$

The required area is given by:

$$A = \frac{(Q + Q_r) \cdot C_o}{\text{SLR}} = \frac{(409 + 409) \times 3.896}{3.640} = 876 \text{ m}^2$$

Note: the solids loading rate value of 3.640 kgSS/m²·hour can approximately be also obtained by interpolation in Table 33.4 (*poor* settleability, $R = 1.0$, and $\text{MLSS} = 3,896$ mg/L).

According to the clarification criteria, the required area is 897 m², and according to the thickening criteria, the required area is 876 m². The higher value should be adopted, that is, **897 m²**. In this case, the clarification is controlling the process, as it is more restrictive in terms of loading rates and required area.

(c) Calculation of the surface area based on the direct equation for Q/A

For the *clarification* criteria, the Q/A value was calculated in the above item as being 0.456 m/hour, and the required area was equal to 897 m².

For the *thickening* criteria, the Q/A value is directly obtained from Equation 33.10:

$$\begin{aligned} Q/A &= \frac{m \cdot [R \cdot v_o \cdot e^{-(K \cdot C_o)}]^n}{(R + 1) \cdot C_o} = \frac{6.26 \cdot [1.0 \times 6.2 \cdot e^{-(0.67 \times 3.896)}]^{0.69}}{(1.0 + 1) \times 3.896} \\ &= 0.467 \text{ m/hour} \end{aligned}$$

Since $Q = 409$ m³/hour $\rightarrow A = 409/0.467 = 876$ m²

Example 33.2 (Continued)

This value is, as expected, identical to that obtained in item (b), for thickening. Once again, the largest area (or the lowest Q/A value) should be adopted. In this sense, $Q/A = 0.456$ m/hour is adopted, and the area is equal to **897 m²**. The Q/A value could have also been approximately obtained from Figure 33.8.

(d) Calculation of the surface area using Table 33.5 (HLR and SLR criteria)

With $R = 1.0$ and *poor* settleability, according to Table 33.5:

For $MLSS = 3,800$ mg/L: clarification: $Q/A = 0.90$ m/hour; thickening: $Q/A = 0.50$ m/hour

For $MLSS = 4,000$ mg/L: clarification: $Q/A = 0.43$ m/hour; thickening: $Q/A = 0.43$ m/hour

Since $MLSS = 3,896$ mg/L, linearly interpolating the values, the following is obtained:

Clarification: $Q/A = 0.46$ m/hour

Thickening: $Q/A = 0.47$ m/hour

By adopting the lowest value ($Q/A = 0.46$ m/hour), and since $Q = 409$ m³/hour:

$$A = 409/0.46 = \mathbf{889 \text{ m}^2}$$

The A values obtained from the three methods are naturally the same (apart from a small difference in the result obtained from Table 33.5, as the table does not provide continuous solutions).

The example of Chapter 34 (Section 34.3, conventional activated sludge) adopts the settleability range between *fair* and *poor*. It is interesting to compare the results to have an idea of the influence of the settleability ranges on the final result.

Example 33.3

An activated sludge plant is working with a high sludge blanket level, and is facing problems concerning solids losses in the final effluent from the sedimentation tank. SVI tests indicated that the sludge settleability can be considered *fair*, according to the classification of Table 33.2. Analyse the loading conditions of the sedimentation tanks and propose control measures, using Table 33.5. Data are:

- average influent flow: $Q = 250$ m³/hour
- return sludge flow: $Q_r = 150$ m³/hour

Example 33.3 (Continued)

- Mixed liquor suspended solids concentration: $MLSS = 4,000 \text{ mg/L} = 4.0 \text{ kg/m}^3$
- Surface area of the secondary sedimentation tanks: $A = 200 \text{ m}^2$

Solution:**(a) Evaluation of the loading conditions**

The return sludge ratio is $Q_r/Q = 150/250 = 0.6$

From Table 33.5, for $MLSS = 4,000 \text{ mg/L}$, $R = 0.6$, and *fair* settleability, the maximum allowable values for Q/A are: $1.16 \text{ m}^3/\text{m}^2 \cdot \text{hour}$ (clarification) and $1.01 \text{ m}^3/\text{m}^2 \cdot \text{hour}$ (thickening). In this case, the thickening controls the process, since it is more restrictive than the clarification. The lowest value should be adopted ($1.01 \text{ m}^3/\text{m}^2 \cdot \text{h}$). However, considering the present conditions of the wastewater treatment plant, the actual Q/A value is $250/200 = 1.25 \text{ m}^3/\text{m}^2 \cdot \text{hour}$. The sedimentation tanks are, therefore, overloaded due to the fact that the Q/A applied ($1.25 \text{ m}^3/\text{m}^2 \cdot \text{hour}$) is higher than the maximum Q/A allowed ($1.01 \text{ m}^3/\text{m}^2 \cdot \text{hour}$).

It is necessary to take operational control measures, which can involve one of the two following alternatives, or a combination between both: (a) reduce $MLSS$ concentration and (b) increase R . Q cannot be altered, because it is independent of operational control. The surface area A also cannot be modified, because this is the existing available area. Thus, the Q/A applied remains the same ($1.25 \text{ m}^3/\text{m}^2 \cdot \text{hour}$).

(b) Reduce the MLSS concentration

A reduction in $MLSS$ implies a reduced applied solids load. The lowering of $MLSS$ should be such that the maximum allowable Q/A value, extracted from Table 33.5, is higher than the applied Q/A value ($1.25 \text{ m}^3/\text{m}^2 \cdot \text{hour}$). From Table 33.5, *fair* settleability, $R = 0.6$, the Q/A value for thickening immediately higher than 1.25 is $1.30 \text{ m}^3/\text{m}^2 \cdot \text{hour}$, which corresponds to $MLSS$ of $3,600 \text{ mg/L}$. In these conditions, the maximum Q/A allowed for clarification is $1.42 \text{ m}^3/\text{m}^2 \cdot \text{hour}$ (see Table 33.5), higher than the Q/A value for thickening. Therefore, the concentration of $MLSS$ in the reactor should be decreased from $4,000 \text{ mg/L}$ to $3,600 \text{ mg/L}$, by means of an increase in the removal of excess sludge, aiming at reducing the load of influent solids to the secondary sedimentation tank.

(c) Increase the return sludge ratio R

A reduction in R implies a higher solids absorption capacity by the sedimentation tank. A maximum allowable Q/A value higher than $1.25 \text{ m}^3/\text{m}^2 \cdot \text{hour}$ should be obtained. From Table 33.5, *fair* settleability, $MLSS = 4,000 \text{ mg/L}$,

Example 33.3 (Continued)

there is no Q/A value higher than $1.25 \text{ m}^3/\text{m}^2\cdot\text{hour}$. The highest value, $1.22 \text{ m}^3/\text{m}^2\cdot\text{hour}$, corresponding to $R = 1.2$, is slightly lower than the Q/A value applied. Hence, it would be necessary to increase R from 0.6 to more than 1.2, which may not be the best solution, in case there is no sufficient pumping capacity. Besides that, the Q/A value for clarification would still not be met, because the variation in R does not affect the clarification.

(d) Reduce MLSS and simultaneously increase R

The joint action in MLSS and R allows different combinations, generating Q/A values higher than that of the applied Q/A ($1.25 \text{ m}^3/\text{m}^2\cdot\text{hour}$). A possible combination is $\text{MLSS} = 3,800 \text{ mg/L}$ and $R = 0.8$, which results in a maximum allowable Q/A equal to $1.29 \text{ m}^3/\text{m}^2\cdot\text{hour}$ (clarification) and $1.26 \text{ m}^3/\text{m}^2\cdot\text{hour}$ (thickening). In the two conditions (clarification and thickening), the maximum allowable Q/A values are higher than the applied Q/A value.

Example 33.4

An activated sludge plant is showing a weak performance in the BOD removal and in nitrification. The analysis of the process indicated that the concentration of MLSS is very low, and it needs to be increased. The plant has an oxygenation capacity sufficient to provide more oxygen, even with very high MLSS concentrations. Verify which concentration of MLSS can be maintained in the reactor without causing overloading problems to the secondary sedimentation tank. The sludge settleability in the plant is considered *fair*. The data of interest are:

- average influent flow: $Q = 200 \text{ m}^3/\text{hour}$
- return sludge ratio: $R = 1.0$
- surface area of the secondary sedimentation tanks: 180 m^2

Solution:

The applied Q/A value is $200/180 = 1.11 \text{ m}^3/\text{m}^2\cdot\text{hour}$. From Table 33.5, for *fair* settleability and $R = 1.0$, the maximum allowable Q/A value (thickening) immediately higher than the applied value of $1.11 \text{ m}^3/\text{m}^2\cdot\text{hour}$ is $1.17 \text{ m}^3/\text{m}^2\cdot\text{hour}$, which is associated with a concentration of MLSS of $4,000 \text{ mg/L}$. For this concentration of MLSS, the maximum allowable value (clarification) is $1.16 \text{ m}^3/\text{m}^2\cdot\text{hour}$, which is also satisfactory, as it is higher than the applied value. Therefore, the MLSS concentration in the reactor can be increased up to $4,000 \text{ mg/L}$, as long as the *fair* settleability conditions and the Q and R values are not altered.

Table 33.6. Minimum and recommended values for the sidewater depth of secondary sedimentation tanks

Tank diameter (m)	Liquid sidewater depth (m)	
	Minimum	Recommended
<12	3.0	3.3
12–20	3.3	3.6
20–30	3.6	3.9
30–40	3.9	4.2
>40	4.2	4.5

Source: Adapted from WEF/ASCE (1992)

33.3 DESIGN DETAILS IN SECONDARY SEDIMENTATION TANKS

33.3.1 Sidewater depth

The liquid depth of a sedimentation tank is usually referred to as the sidewater depth (SWD) of the cylindrical part (wall) in a circular sedimentation tank, and as depth of the final end in a rectangular sedimentation tank.

The current tendency is to adopt high depths to ensure a better accommodation of the sludge blanket in its occasional expansions, allowing a better quality of the effluent. Table 33.6 presents values suggested by WEF/ASCE (1992), according to the diameter of the tank.

It should be remembered that, in tropical countries, where nitrification occurs almost systematically in the reactors, the occurrence of denitrification in secondary sedimentation tanks is very likely to occur in case there is no intentional biological nitrogen removal in the reactor. A long sludge detention time in the sedimentation tank can allow denitrification, with the release of gaseous nitrogen bubbles, which adhere in their upward movement to the settling sludge, thus carrying it to the surface. Therefore, long **sludge** detention times should be avoided in the sedimentation tank, which means that high sludge blanket levels and low underflow rates should be avoided.

In case the circular tank has a flat bottom, in view of the sludge removal by suction, the design of the sedimentation tank should be more conservative. WEF/ASCE (1992) suggest a 0.35 m/hour reduction in the hydraulic loading rate, compared with the design of a conical-bottom sedimentation tank, which has a higher absorption capacity of the variation of the sludge blanket level (due to the additional volume provided by the conical section).

In sedimentation tanks with high bottom slopes and no mechanical sludge removal (Dortmund-type tanks) the sidewater depth is lower, but should be higher than 0.5 m, according to the Brazilian standards (ABNT, 1989).

33.3.2 Effluent weirs

The design of the effluent weirs is also an important item in the conception of secondary sedimentation tanks to minimise the transportation of solids with the

Table 33.7. Maximum weir loading rate values

Sedimentation tank	Condition	Weir loading rate (m ³ /m-hour)	
		Average flow	Maximum flow
Small	–	5	10
Large	Outside the upturn zone of the current	–	15
	Inside the upturn zone of the current	–	10

Source: Metcalf and Eddy, 1991

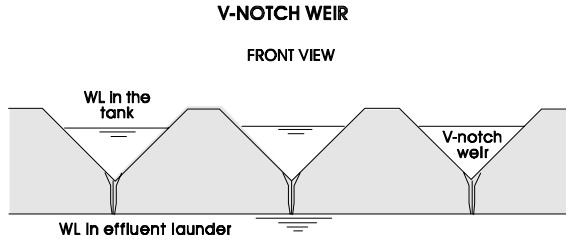

Figure 33.9. Detail of a V-notch effluent weir

final effluent. The weirs can be either continuous or, preferably, with V-notches (Figure 33.9). The latter one is more recommended as it is less influenced by occasional differences in the fixing level of the weirs.

The required length of the weirs is calculated based on the **weir loading rate** (m³/hour per metre of weir), which corresponds to the flow per unit length of the weir. The weir rate is associated with the liquid approaching velocity: high velocities could carry solids from the sludge blanket. Since the important factor is the approaching velocity, in V-notch weirs the flow that goes through the openings is not influential, and the velocity is dictated by the influent flow that approaches all the weir length.

Metcalf and Eddy (1991) suggest the weir loading rate values listed in Table 33.7. WEF/ASCE (1992) suggest 5 m³/m-hour for small plants and 8 m³/m-hour for larger plants.

In well-designed circular tanks, the perimeter of the tank usually meets the weir loading rate criteria. English experiences (Johnstone *et al.*, 1979) indicated that single-faced weir launders (even if with higher loading rates) are preferable to double-faced weir launders (internal to the tank). In double-faced weir launders, the face closer to the external wall receives the rising liquid current parallel to the wall, carrying a larger quantity of solids.

33.3.3 Other design details

The following comments can be made on circular and rectangular sedimentation tanks provided with mechanised sludge removal (Metcalf and Eddy, 1991;

WEF/ASCE, 1992):

Rectangular sedimentation tanks:

- The distribution of the influent flow should be homogeneous, to avoid excessive horizontal velocities and hydraulic short circuits.
- It is recommended that the length/depth ratio does not exceed the value of 10 to 15.
- If a tank is wider than 6 m, multiple sludge collectors can be adopted to allow a width up to 24 m.
- The sludge collecting mechanism should have a high capacity to avoid preferential routes of the liquid through the sludge. It should also be sturdy to remove and transport thicker sludges accumulated during interruptions in the operation.
- The most common sludge removal mechanisms are: (a) scraper with travelling bridge (see Figure 33.2), (b) scraper with submerged chains, and (c) suction removers. The scraping mechanisms usually transport the sludge to a hopper in the inlet end of the tank.

Circular sedimentation tank:

- The most usual diameters range from 10 m to 40 m.
- The diameter/sidewater depth ratio should not exceed the value of 10.
- The sludge can be removed either by rotating scrapers that direct the sludge to a hopper at the centre of the tank or by suction mechanisms supported by rotating bridges.
- The bottom of the tank should have a slope of approximately 1:12, in the case of sludge removal by scrapers, or be flat, in the case of removal by suction.

33.4 DESIGN OF PRIMARY SEDIMENTATION TANKS

Primary sedimentation tanks are used in conventional activated sludge plants. Their main function is to reduce the organic matter load to the biological treatment stage. The main design parameters are presented in Tables 33.8 and 33.9.

Weir loading rates are not important in primary sedimentation tanks followed by activated sludge systems.

The Brazilian standards for the design of wastewater treatment plants (ABNT, 1989) recommend the following points:

General considerations:

- A WWTP with a design maximum flow higher than 250 L/s should have more than one primary sedimentation tank.
- The sludge removal pipes should have a minimum diameter of 150 mm; the sludge gravity transport piping should have a minimum slope of 3%

Table 33.8. Typical design parameters for primary sedimentation tanks followed by activated sludge systems

Item	Primary settling followed by secondary treatment		Primary settling with excess activated sludge return	
	Range	Typical	Range	Typical
Hydraulic loading rate (Q_{average}) ($\text{m}^3/\text{m}^2 \cdot \text{hour}$)	1.4–2.1	–	1.0–1.4	–
Hydraulic loading rate (Q_{max}) ($\text{m}^3/\text{m}^2 \cdot \text{hour}$)	3.4–5.1	4.3	2.0–2.9	2.6
Detention time (hour)	1.5–2.5	2.0	1.5–2.5	2.0

Source: Metcalf and Eddy (1991)

Table 33.9. Typical design parameters for rectangular and circular primary sedimentation tanks

Item	Rectangular tank		Circular tank	
	Range	Typical	Range	Typical
Depth (m)	3.0–4.5	3.6	3.0–4.5	3.6
Length (m)	15–90	24–40	–	–
Width (m)	3–24	5–10	–	–
Diameter (m)	–	–	3–60	12–45
Bottom slope (%)	–	–	6–17	8

Source: Metcalf and Eddy (1991)

and the bottom sludge removal should be such that allows the observation and control of the sludge removed.

- The sludge accumulation hopper should have walls with slopes equal to or higher than 1.5 vertical to 1.0 horizontal, with a bottom base with a minimum dimension of 0.60 m.

Primary sedimentation tank with mechanised sludge removal:

- The removal device should have a velocity equal to or lower than 20 mm/s in the case of rectangular sedimentation tanks, and a peripheral velocity equal to or lower than 40 mm/s in the case of circular sedimentation tanks.
- The minimum sidewater depth should be equal to or higher than 2.0 m
- For rectangular sedimentation tanks, the length/sidewater depth ratio should be equal to or greater than 4:1; the width/sidewater depth ratio should be equal to or greater than 2:1 and the length/width ratio should be equal to or greater than 2:1.
- For rectangular sedimentation tanks, the horizontal flow velocity should be equal to or lower than 50 mm/s; when receiving excess activated sludge, the velocity should be equal to or lower than 20 mm/s.

**Primary sedimentation tank without mechanised sludge removal
(Dortmund-type tanks):**

- The minimum sidewater depth should be equal to or higher than 0.5 m.
- The sedimentation tank can be either circular or square in plan, with a single conical or pyramidal sludge hopper, sludge discharge by gravity, wall slope equal to or greater than 1.5 vertical by 1.0 horizontal, and diameter or diagonal not exceeding 7.0 m.
- The sedimentation tank can be rectangular in plan, fed by the smaller side, provided that the tank consists totally of square-based pyramidal hoppers, with sides lower than 5.0 m and with individual sludge discharges.
- The minimum hydraulic load for sludge removal should be five times the head loss calculated for water, and not lower than 1.0 m.

34

Design example of an activated sludge system for organic matter removal

34.1 INTRODUCTION

Design the biological stage of an activated sludge system to treat the wastewater generated in the community described in the example in Chapter 2. The treatment units should be designed for BOD removal, using the **conventional activated sludge** variant. The occurrence of nitrification should be taken into consideration, but the system should not be designed for biological nutrient (nitrogen and phosphorus) removal. The design should be made for the 20th year of operation. For that year, input data are as follows (see Section 2.2.7):

- Population equivalent: 67,000 inhabitants
- Influent flow: average: 9,820 m³/d
 maximum: 19,212 m³/d
 minimum: 4,003 m³/d
- Influent loads: BOD: 3,350kg/d
 SS: 3,720kg/d (per capita load of 60 gSS/
 inhabitant-day)
 TKN: 496kg/d (per capita load of 8 gTKN/
 inhabitant-day)

- Influent concentrations: BOD: 341mg/L
SS: 379mg/L
TKN: 51mg/L
- Temperature of the liquid: average of the coldest month: 20 °C
average of the warmest month: 25 °C
- Altitude: 800 m
- Desired characteristics for the effluent: BOD: 20mg/L
SS: 30mg/L

34.2 MODEL PARAMETERS AND COEFFICIENTS

(a) Kinetic and stoichiometric parameters

According to Table 32.2, the following values were adopted:

$$Y = 0.6 \text{ gVSS/gBOD}_5$$

$$K_d = 0.08 \text{ d}^{-1} (20 \text{ }^\circ\text{C})$$

$$\theta = 1.07 \text{ (temperature correction for } K_d)$$

$$\text{Ratio } O_2/\text{SS}_b = 1.42 \text{ gO}_2 \text{ per g biodegradable VSS}$$

$$\text{Ratio } \text{BOD}_u/\text{BOD}_5 = 1.46$$

(b) Relations between solids

According to Table 32.2, the following values were adopted:

Raw sewage:

$$\text{SS}_b/\text{VSS} = 0.60$$

$$\text{VSS}/\text{SS} = 0.80$$

Biological solids to be generated:

$$\text{SS}_b/\text{SS} = 0.80$$

$$\text{VSS}/\text{SS} = 0.90$$

After a time equal to the sludge age:

$$\text{VSS}/\text{SS} = 0.77 \text{ (conventional activated sludge; system with solids in the raw sewage and with primary sedimentation tank)}$$

(initial estimate – see Table 31.6; exact value to be calculated later on):

(c) Aeration coefficients

According to the information provided in Chapter 11, the following values can be adopted:

$$C_s = 9.02 \text{ (clean water, } 20 \text{ }^\circ\text{C)}$$

$$\alpha = 0.85$$

$$\beta = 0.90$$

$$\theta = 1.024 \text{ (for correction of } K_L a \text{ for the operating temperature)}$$

$$\text{Specific gravity of air} = 1.2 \text{ kg/m}^3 \text{ (20 }^\circ\text{C, altitude} = 0 \text{ m)}$$

$$\text{Fraction of O}_2 \text{ in air (by weight)} = 0.23 \text{ gO}_2/\text{g air}$$

34.3 DESIGN OF THE CONVENTIONAL ACTIVATED SLUDGE SYSTEM

34.3.1 Design parameters

(a) Removal efficiencies assumed for the primary sedimentation tank

$$\text{BOD}_5 = 30\%$$

$$\text{SS} = 60\%$$

$$\text{TKN} = 20\%$$

(b) Reactor

Fully aerobic reactor (without anoxic or anaerobic zones)

$$\theta_c = 6 \text{ days}$$

$$\text{MLVSS} = 3,000 \text{ mg/L}$$

$$R = 1.0 \text{ (return sludge ratio)}$$

(c) Aeration system

$$\text{Minimum DO (with } Q_{\max}): C_L = 1.0 \text{ mg/L}$$

$$\text{Average DO (with } Q_{\text{av}}): C_L = 2.0 \text{ mg/L}$$

Mechanical aeration (low speed):

$$\text{OE (standard conditions)} = 1.8 \text{ kgO}_2/\text{kWh}$$

Diffused air (fine bubbles):

$$\text{O}_2 \text{ transfer efficiency} = 0.15$$

$$\text{Efficiency of the motor and the blower } \eta = 0.60$$

(d) Secondary sedimentation tank

Limiting flux (settleability ratios are between fair and poor) (see Table 33.2)

Taking the arithmetic mean for the values of v_o , K , m and n (Table 33.3) corresponding to *fair* and *poor* settleability, thus characterising settleability as *fair-poor*:

$$v_o = 7.40 \text{ m/hour}$$

$$K = 0.59 \text{ m}^3/\text{kg}$$

$$m = 7.34$$

$$n = 0.71$$

34.3.2 Effluent loads and concentrations from the primary sedimentation tank (influent to the reactor)

In the primary sedimentation tank, the main pollutants are removed according to the percentages given in Section 34.3.1.a. The effluent loads and concentrations are:

$$\text{Effluent} = \text{Influent} \cdot \frac{(100 - \text{Efficiency})}{100}$$

$$\begin{aligned} \text{Effluent BOD} &= 3,350 \text{ kg/d} \cdot (100 - 30)/100 = 2,345 \text{ kg/d} \\ &= 341 \text{ mg/L} \cdot (100 - 30)/100 = 239 \text{ mg/L} \end{aligned}$$

$$\begin{aligned} \text{Effluent SS} &= 3,720 \text{ kg/d} \cdot (100 - 60)/100 = 1,488 \text{ kg/d} \\ &= 379 \text{ mg/L} \cdot (100 - 60)/100 = 152 \text{ mg/L} \end{aligned}$$

$$\begin{aligned} \text{Effluent TKN} &= 496 \text{ kg/d} \cdot (100 - 20)/100 = 397 \text{ kg/d} \\ &= 51 \text{ mg/L} \cdot (100 - 20)/100 = 40 \text{ mg/L} \end{aligned}$$

34.3.3 Soluble BOD of the final effluent

- Effluent SS concentration:

$$X_{\text{eff}} = 30 \text{ mg/L (stated in the problem)}$$

- Effluent VSS concentration:

$$X_{\text{Veff}} = (\text{VSS/SS ratio with } \theta_c \text{ days}) \cdot X_{\text{eff}} = 0.77 \times 30 = 23 \text{ mgVSS/L}$$

- Correction of K_d for the temperature of the coldest month (20 °C): no correction because the temperature of the coldest month coincides with the standard temperature of 20 °C: $K_d = 0.08 \text{ d}^{-1}$
- Coefficient f_b (SS_b/VSS ratio) (Equation 31.2):

$$\begin{aligned} f_b &= \frac{f_b'}{1 + (1 - f_b') \cdot K_d \cdot \theta_c} = \frac{0.80}{1 + (1 - 0.80) \times 0.08 \times 6} \\ &= 0.73 \text{ mgSS}_b/\text{VSS} \end{aligned}$$

- Concentration of biodegradable solids in the effluent:

$$X_{\text{b_eff}} = f_b \cdot X_{\text{Veff}} = 0.73 \times 23 = 17 \text{ mgSS}_b/\text{L}$$

- Particulate BOD₅ in the effluent (Section 31.6):

$$\text{BOD}_{5_{\text{part}}} = \frac{(\text{BOD}_u/X_b) \cdot X_{b_{\text{eff}}}}{(\text{BOD}_u/\text{BOD}_5)} = \frac{1.42 \times 17 \text{ mg/L}}{1.46} = 16 \text{ mg/L}$$

- Maximum soluble BOD to be obtained (Equation 31.10 rearranged):

$$\text{BOD}_{5_{\text{sol}}} = \text{BOD}_{5_{\text{tot}}} - \text{BOD}_{5_{\text{part}}} = 20 - 16 = 4 \text{ mg/L}$$

34.3.4 Efficiency of the system in BOD removal

$$E = (\text{BOD}_{\text{infl}} - \text{BOD}_{\text{eff}}) \times 100/\text{BOD}_{\text{infl}}$$

In the system (primary sedimentation tank + biological stage): $E = (341 - 20) \times 100/341 = 94.1\%$

In the biological stage: $E = (239 - 20) \times 100/239 = 91.6\%$

34.3.5 BOD₅ load removed in the biological stage

$$S_r = Q_{\text{average}} \times (\text{BOD}_{\text{totinfl}} - \text{BOD}_{\text{sol}_{\text{eff}}})$$

$$S_r = Q \cdot (S_0 - S)/1,000 = 9,820 \times (239 - 4)/1,000 = 2,308 \text{ kgBOD}_5/\text{d}$$

34.3.6 Distribution of the solids in the treatment

The purpose of this section is to estimate the total production of solids (raw sewage + biological solids) and the ratio VSS/SS. Since this is a laborious task, this section can be replaced (for predominantly domestic sewage) by simplified estimates of the production of solids and the VSS/SS ratio (Section 31.19 and Table 31.6). Thus, in a more straightforward and simplified version of the example, the present section can be omitted, and the calculations in the following paragraph may be adopted.

From Table 31.6, for a system with sedimentation tank, $\theta_c = 6 \text{ d}$, $Y = 0.6$ and $K_d = 0.08 \text{ d}^{-1}$:

- $\text{VSS}/\text{SS} = 0.76$
- $\text{SS}/S_r = 0.87 \text{ kgSS/kgBOD}_5 \text{ rem} \rightarrow P_x = 0.87 \text{ kgSS/kgBOD} \times 2,308 \text{ kgBOD/d} = \mathbf{2,008 \text{ kgSS/d}}$

For a detailed calculation, the following steps should be followed.

(a) Influent solids to the reactor (effluent from the primary sedimentation tank)

- Total suspended solids:

$$P_x = 1,488 \text{ kgSS/d (Section 34.3.2)}$$

- Volatile suspended solids:

$$\begin{aligned} P_{xv} &= (\text{VSS/SS ratio in the raw sewage}) \cdot P_x = 0.8 \times 1,488 \\ &= 1,190 \text{ kgVSS/d} \end{aligned}$$

- Biodegradable volatile suspended solids (they are not added to the mass balance as they are already included in the influent BOD. They will be stabilised, causing the generation of biological solids – they are just used to compute P_{xnb}):

$$P_{xb} = (\text{SS}_b/\text{VSS in the raw sewage}) \cdot P_{xv} = 0.60 \times 1,190 = 714 \text{ kgSS}_b/\text{d}$$

- Non-biodegradable volatile suspended solids:

$$P_{xnb} = P_{xv} - P_{xb} = 1,190 - 714 = 476 \text{ kgSS}_{nb}/\text{d}$$

- Inorganic suspended solids (non-volatile):

$$P_{xi} = P_x - P_{xv} = 1,488 - 1,190 = 298 \text{ kgSS}_i/\text{d}$$

(b) Biological solids generated in the reactor

- Volatile suspended solids produced:

$$\text{Produced } P_{xv} = Y \cdot S_r = 0.6 \times 2,308 \text{ kgBOD}_5/\text{d} = 1,385 \text{ kgVSS}/\text{d}$$

- Total suspended solids produced:

$$\begin{aligned} \text{Produced } P_x &= P_{xv}/(\text{VSS/SS ratio in the generation of solids}) \\ &= 1,385/0.9 = 1,539 \text{ kgSS}/\text{d} \end{aligned}$$

- Inorganic suspended solids produced:

$$\begin{aligned} \text{Produced } P_{xi} &= \text{Produced } P_x - \text{Produced } P_{xv} = 1,539 - 1,385 \\ &= 154 \text{ kgSS}_i/\text{d} \end{aligned}$$

- Biodegradable suspended solids produced:

$$\text{Produced } P_{xb} = f_b \cdot \text{produced } P_{xv} = 0.73 \times 1,385 = 1,011 \text{ kgSS}_b/\text{d}$$

- Non-biodegradable suspended solids produced:

$$\begin{aligned}\text{Produced } P_{\text{xn b}} &= \text{Produced } P_{\text{xv}} - \text{Produced } P_{\text{xb}} = 1,385 - 1,011 \\ &= 374 \text{ kgSS}_{\text{nb}}/\text{d}\end{aligned}$$

- Biodegradable suspended solids destroyed in the endogenous respiration:

$$\begin{aligned}\text{Destroyed } P_{\text{xb}} &= \text{Produced } P_{\text{xb}} \cdot (K_{\text{d}} \cdot \theta_{\text{c}}) / (1 + f_{\text{b}} \cdot K_{\text{d}} \cdot \theta_{\text{c}}) \\ &= 1,011 \times (0.08 \times 6) / (1 + 0.73 \times 0.08 \times 6) \\ &= 359 \text{ kgSS}_{\text{b}}/\text{d}\end{aligned}$$

- Remaining biodegradable suspended solids (net production):

$$\text{Net } P_{\text{xb}} = \text{Produced } P_{\text{xb}} - \text{Destroyed } P_{\text{xb}} = 1,011 - 359 = 652 \text{ kgSS}_{\text{b}}/\text{d}$$

- Remaining volatile suspended solids (net production):

$$\text{Net } P_{\text{xv}} = \text{Net } P_{\text{xb}} + \text{Produced } P_{\text{xn b}} = 652 + 374 = 1,026 \text{ kgVSS}/\text{d}$$

(c) Summary of the reactor

Total production = Input from the influent sewage + Production of biological solids in the reactor

- Inorganic suspended solids:

$$P_{\text{xi}} = 298 + 154 = 452 \text{ kgSS}_{\text{i}}/\text{d}$$

- Non-biodegradable suspended solids:

$$P_{\text{xn b}} = 476 + 374 = 850 \text{ kgSS}_{\text{nb}}/\text{d}$$

- Biodegradable suspended solids:

$$P_{\text{xb}} = 0 + 652 = 652 \text{ kgSS}_{\text{b}}/\text{d}$$

- Volatile suspended solids:

$$P_{\text{xv}} = P_{\text{xn b}} + P_{\text{xb}} = 850 + 652 = 1,502 \text{ kgVSS}/\text{d}$$

- Total suspended solids:

$$P_{\text{x}} = P_{\text{xv}} + P_{\text{xi}} = 1,502 + 452 = \mathbf{1,954 \text{ kgSS}/\text{d}}$$

- Resultant VSS/SS ratio:

$\text{VSS}/\text{SS} = 1,502/1,954 = \mathbf{0.77}$ (This value matches with the initially adopted value – see Section 34.2.b. If it had been substantially different, the initial value should be altered, and the calculations re-done)

- Ratio SS produced by BOD₅ removed:

$\text{SS}/S_{\text{r}} = 1,954/2,308 = 0.85 \text{ kgSS}/\text{kgBOD}_5 \text{ rem}$ (a value very close to the value of Section 31.19, Table 31.6)

The significant contribution represented by the solids of the raw sewage can be observed. To design the sludge treatment stage, the solids removed from the

primary sedimentation tank (primary sludge) should be added to these values calculated for the solids produced in the reactor (secondary sludge).

34.3.7 Reactor volume

According to Equation 31.4 (S_r is the BOD load removed – see Section 31.4):

$$V = \frac{Y \cdot \theta_c \cdot S_r}{X_v \cdot (1 + f_b \cdot K_d \cdot \theta_c)} = \frac{0.6 \times 6 \times 2,308 \times 1,000}{3,000 \times (1 + 0.73 \times 0.08 \times 6)} = 2,051 \text{ m}^3$$

Number of reactors to be used: **2**

Volume of each reactor: $V_1 = 2,051/2 = 1,026 \text{ m}^3$

Depth: 4.0 m

Area required: $1,026/4.0 = 257 \text{ m}^2$

Dimensions: length **L = 32.0 m**; width **B = 8.0 m**

The ratio $L/B = 32.0/8.0 = 4$ allows, in this example, the symmetrical allocation of four aerators. Reactors with a different number of aerators should have different ratios.

- Hydraulic detention time:

$$t = V/Q = 2,051/9,820 = 0.21 \text{ d} = 5.0 \text{ hours}$$

- Substrate utilisation rate U:

$$U = \frac{S_r}{X_v \times V} = \frac{2,308 \times 1,000}{3,000 \times 2,051} = 0.38 \text{ kgBOD}_5/\text{kgMLVSS} \cdot \text{d}$$

- F/M ratio:

$$\begin{aligned} F/M &= \frac{\text{Influent BOD load to the reactor}}{X_v \cdot V} = \frac{2,345 \times 1,000}{3,000 \times 2,051} \\ &= 0.38 \text{ kgBOD}_5/\text{kgMLVSS} \cdot \text{d} \end{aligned}$$

34.3.8 Excess sludge removal

Total SS produced (influent + produced in the reactor) (see Section 34.3.6.c) = 1,954 kgSS/d

SS leaving with the final effluent = $Q \cdot \text{SS}_{\text{effluent}}/1,000 = 9,820 \times 30/1,000 = 295 \text{ kgSS/d}$

SS to be removed from the system = total SS – SS effluent = $1,954 - 295 = 1,659 \text{ kgSS/d}$

(a) Option: direct removal from the reactor

Concentration: $\text{MLSS} = \text{MLVSS}/(\text{VSS}/\text{SS}) = 3,000/0.77 = 3,896 \text{ mg/L}$

Volume to be removed per day: $Q_{\text{ex}} = \text{load}/\text{concentration} = 1,659 \times 1,000/3,896 = 426 \text{ m}^3/\text{d}$

(b) Option: removal from the sludge return line

Concentration: RASS = MLSS. $(1 + 1/R) = 3,896 \times (1 + 1/1) = 7,792 \text{ mg/L}$

Volume to be removed per day: $Q_{\text{ex}} = \text{load}/\text{concentration} = 1,659 \times 1,000/7,792 = 213 \text{ m}^3/\text{d}$

Note that, with the return sludge ratio of $R = 1$, the excess sludge flow is double and the SS concentration is half, when the sludge is directly removed from the reactor, compared with the removal from the return sludge line. The solids load to be removed is, naturally, the same.

34.3.9 Oxygen requirements**(a) O₂ requirements in the field**

See equations in Section 31.16.

$$a' = (\text{BOD}_u/\text{BOD}_5) - (\text{BOD}_u/X_b) \cdot Y = 1.46 - 1.42 \times 0.6 = 0.608 \text{ kgO}_2/\text{kgBOD}_5$$

$$b' = (\text{BOD}_u/X_b) \cdot f_b \cdot K_d = 1.42 \times 0.73 \times 0.08 = 0.083 \text{ kgO}_2/\text{kgVSS}$$

Demand for synthesis: $a' \cdot S_r = 0.608 \times 2,308 = 1,403 \text{ kgO}_2/\text{d}$

Demand for endogenous respiration: $b' \cdot X_v \cdot V = 0.083 \times 3,000 \times 2,051/1,000 = 511 \text{ kgO}_2/\text{d}$

Demand for nitrification: 1,344 kgO₂/d (see Item 'b' below – nitrification)

Saving with denitrification: 0 kgO₂/d (there is no intentional denitrification in the reactor)

- OR average: total demand (for Q_{av}) = $1,403 + 511 + 1,344 - 0 = 3,258 \text{ kgO}_2/\text{d}$
- Total demand (for Q_{max}): $\text{OTR}_{\text{field}} = (Q_{\text{max}}/Q_{\text{av}}) \cdot \text{OR}_{\text{av}} = (19,212/9,820) \times 3,258 = 1.96 \times 3,258 = 6,374 \text{ kgO}_2/\text{d}$

Demand to be satisfied in the field: total demand for Q_{max}

Average, O₂ required per kgBOD₅ removed: $(1,403 + 511)/2,308 = 0.83 \text{ kgO}_2/\text{kgBOD}_5$ (very similar to the value shown in Table 31.6)

OTR/influent BOD to reactor ratio = $6,374/2,345 = 2.72 \text{ kgO}_2/\text{kgBOD}_5$

(b) Nitrification

Assume 100% efficiency in the nitrification.

Ammonia fraction in the excess sludge: 0.1 kgTKN/kgVSS (assumed)

Influent TKN load to the reactor (Section 34.3.2): 397 kgTKN/d

TKN load in the excess sludge: $0.1 \cdot P_{\text{xv}} \text{ net} = 0.1 \times 1,026 = 103 \text{ kgTKN/d}$ (see Section 34.3.6.b)

TKN load to be oxidised = influent TKN load – excess sludge TKN load = $397 - 103 = 294 \text{ kgTKN/d}$

Stoichiometric O₂ demand ratio for nitrification: 4.57 kgO₂/kgTKN

O₂ demand for nitrification: $4.57 \times 294 = 1,344 \text{ kgO}_2/\text{d}$ (this value is included in Item 'a' above)

Chapters 35 and 36 provide a more detailed calculation for the estimation of the oxidised TKN load, which should be preferably adopted. The example in Chapter 36 shows the calculation for nitrification, according to this method.

(c) Correction for standard conditions

See equations presented in Chapter 11.

DO saturation concentration as a function of the temperature:

$$C_s = 14.652 - 0.41022 \times T + 0.007991 \times T^2 - 0.000077774 \times T^3$$

C_s in the coldest month (20 °C): C_s = 9.02 mg/L

C_s in the warmest month (25 °C): C_s = 8.18 mg/L

- Standard oxygen transfer rate (SOTR or OTR_{standard}) required in the coldest month (see Section 34.2.c for parameters):

$$\begin{aligned} \text{OTR}_{\text{standard}} &= \frac{\text{OTR}_{\text{field}}}{\frac{\beta \cdot f_H \cdot C_s - C_L}{C_s(20^\circ\text{C})} \cdot \alpha \cdot \theta^{T-20}} = \frac{6,374}{\frac{0.9 \times 0.92 \times 9.02 - 1.0}{9.02} \times 0.85 \times 1.024^{20-20}} \\ &= \frac{6,374}{0.610} = 10,449 \text{ kgO}_2/\text{d} \end{aligned}$$

f_H = correction factor of C_s for the altitude
(= 1 - altitude/9,450) = 1 - 800/9,450 = 0.92

C_L = oxygen concentration to be maintained in the reactor = 1.0 mg/L

C_s(20 °C) = oxygen saturation concentration in clean water, under standard conditions: 9.02 mg/L

T = temperature of the liquid = 20 °C

- Standard oxygen transfer rate (SOTR or OTR_{standard}) required in the warmest month:

$$\begin{aligned} \text{OTR}_{\text{standard}} &= \frac{\text{OTR}_{\text{field}}}{\frac{\beta \cdot f_H \cdot C_s - C_L}{C_s(20^\circ\text{C})} \cdot \alpha \cdot \theta^{T-20}} = \frac{6,374}{\frac{0.9 \times 0.92 \times 8.18 - 1.0}{9.02} \times 0.85 \times 1.024^{25-20}} \\ &= \frac{6,374}{0.613} = 10,398 \text{ kgO}_2/\text{d} \end{aligned}$$

From the values for the coldest month (10,449 kgO₂/d) and the warmest month (10,398 kgO₂/d), the larger should be chosen. Thus:

$$\text{OTR}_{\text{standard}} = 10,449 \text{ kgO}_2/\text{d} = 435 \text{ kgO}_2/\text{hour}$$

34.3.10 Alternative: mechanical aeration

(a) Required power

Oxygenation efficiency under standard conditions (low speed, fixed vertical shaft mechanical aerators): $OE = 1.8 \text{ kgO}_2/\text{kWh}$

Required power: $OTR_{\text{standard}}/OE_{\text{standard}} = 435/1.8 = 242 \text{ kW}$ (323 HP)

Number of aerators for each reactor: **4**

Total number of aerators: $2 \times 4 = \mathbf{8}$

Power required for each aerator: $323/8 = 40.4 \text{ HP}$. Use eight aerators of **50 HP** each

Total installed power: $8 \times 50 = \mathbf{400 \text{ HP}}$ (294 kW)

Power level = Power (kW) · 1,000/V = $294 \times 1,000/2,051 = 143 \text{ W/m}^3$

(power level installed, but not necessarily used)

Resultant $OTR_{\text{standard}} = \text{Power} \times OE = 294 \times 1.8 = 529 \text{ kgO}_2/\text{hour}$
(12,696 kgO₂/d)

(b) Resultant DO concentration

By rearranging Equation 11.25 for the OTR_{standard} and making C_L explicit, the DO concentration in the tank is obtained, for the values of OTR_{field} and the resultant OTR_{standard} . This calculation is done because the supplied aeration capacity is slightly higher than that required, since more power was provided for the aerators (294 kW) compared with the value required (242 kW).

- Concentration of DO during Q_{av} (average flow)

Warmest month:

$$\begin{aligned} C_L &= \beta \cdot f_H \cdot C_s - \left(\frac{OTR_{\text{field}}}{OTR_{\text{standard}}} \cdot \frac{C_{S20}}{\alpha \cdot \theta^{T-20}} \right) \\ &= 0.9 \times 0.92 \times 8.18 - \left(\frac{3,258}{12,696} \cdot \frac{9.02}{0.85 \times 1.024^{(25-20)}} \right) \\ &= 4.35 \text{ mgO}_2/\text{L} \end{aligned}$$

Coldest month:

$$\begin{aligned} C_L &= \beta \cdot f_H \cdot C_s - \left(\frac{OTR_{\text{field}}}{OTR_{\text{standard}}} \cdot \frac{C_{S20}}{\alpha \cdot \theta^{T-20}} \right) \\ &= 0.9 \times 0.92 \times 9.02 - \left(\frac{3,258}{12,696} \cdot \frac{9.02}{0.85 \times 1.024^{(20-20)}} \right) \\ &= 4.75 \text{ mgO}_2/\text{L} \end{aligned}$$

To save energy, lower DO concentrations than this can be reached, if the aeration capacity is reduced by turning off the aerators or lowering the aerator

submergence or speed. Reducing the oxygenation capacity can maintain DO in the desirable range of around 2.0 mg/L (see Section 34.3.1.c).

- Concentration of DO during Q_{\max} (maximum flow)

Warmest month:

$$\begin{aligned} C_L &= \beta \cdot f_H \cdot C_s - \left(\frac{OTR_{\text{field}}}{OTR_{\text{standard}}} \cdot \frac{C_{S20}}{\alpha \cdot \theta^{T-20}} \right) \\ &= 0.9 \times 0.92 \times 8.18 - \left(\frac{6,374}{12,696} \cdot \frac{9.02}{0.85 \times 1.024^{(25-20)}} \right) \\ &= 2.04 \text{ mgO}_2/\text{L} \end{aligned}$$

Coldest month:

$$\begin{aligned} C_L &= \beta \cdot f_H \cdot C_s - \left(\frac{OTR_{\text{field}}}{OTR_{\text{standard}}} \cdot \frac{C_{S20}}{\alpha \cdot \theta^{T-20}} \right) \\ &= 0.9 \times 0.92 \times 9.02 - \left(\frac{6,374}{12,696} \cdot \frac{9.02}{0.85 \times 1.024^{(20-20)}} \right) \\ &= 2.14 \text{ mgO}_2/\text{L} \end{aligned}$$

These DO values for Q_{\max} are higher than the minimum allowable design value of 1.0 mg/L (Section 34.3.1.c), since the installed power is higher than that required. If the aerators had been adopted with a power identical to that required, the preceding calculations would have led to a DO concentration in the warmest month (in the present case, the most critical month) equal to 1.0 mg/L.

34.3.11 Alternative: aeration by diffused air

- Theoretical amount of air required in the field:

R_{air} theoretical

$$\begin{aligned} &= \frac{OTR_{\text{standard}}}{\text{specific gravity air (20 }^\circ\text{C, altit.0 m)} \times \text{fraction O}_2 \text{ air (by weight)}} \\ &= \frac{10,449 \text{ kgO}_2/\text{d}}{1.2 \text{ kg/m}^3 \times 0.23 \text{ gO}_2/\text{g air}} = 37.859 \text{ m}^3 \text{ air/d} \end{aligned}$$

- Actual amount of air required (including O_2 transfer efficiency):
For an efficiency of 15% (see Section 34.3.1.c):

$$\begin{aligned} R_{\text{air actual}} &= R_{\text{air theoretical}}/\text{efficiency} = 37,859/0.15 \\ &= 252,393 \text{ m}^3 \text{ air/d} \end{aligned}$$

- Quantity of air to be used (with safety factor):
Apply a safety factor. Metcalf and Eddy (1991) suggest a value of 2 for sizing the blowers. Since the current calculation has already been made computing the oxygen demand for maximum flow, a lower value of the safety factor could be adopted (say, 1.5).

Adopted $R_{\text{air}} = \text{actual } R_{\text{air}} \times \text{safety factor} = 252,393 \times 1.5 = 378,590 \text{ m}^3 \text{ air/d}$ ($= 265 \text{ m}^3 \text{ air/min}$) ($= 4.4 \text{ m}^3/\text{s}$)

- Energy requirements:
Assume that the head loss in the air piping (ΔH) is 0.4 m. In a real design, the head loss ΔH should be calculated along the air distribution system.

$$P = \frac{Q_g \cdot \rho \cdot g \cdot (d_i + \Delta H)}{\eta} = \frac{4.4 \times 1,000 \times 9.81 \times (4.0 + 0.4)}{0.60}$$

$$= 316,536 \text{ W} = 317 \text{ kW} = 431 \text{ HP}$$

- Resultant oxygenation efficiency:

$$EO = \frac{OTR_{\text{standard}} \times \text{Safety factor}}{P} = \frac{435 \text{ kgO}_2/\text{h} \times 1.5}{317 \text{ kW}}$$

$$= 2.06 \text{ kgO}_2/\text{kW}\cdot\text{hour}$$

- Resultant DO concentrations:

Follow the methodology used in 34.3.10.b.

Note: In the diffused air alternative, a larger depth can be adopted for the reactor (5 to 6 m), thus optimising the transfer of oxygen and reducing the area required.

34.3.12 Area required for the secondary sedimentation tank

Use equations presented in Chapter 33.

- (a) Input data

$$Q = 9,820 \text{ m}^3/\text{d} = 409 \text{ m}^3/\text{hour}$$

$$Q_{\text{max}} = 19,212 \text{ m}^3/\text{d} = 801 \text{ m}^3/\text{hour}$$

$$Q_r = 9,820 \text{ m}^3/\text{d} = 409 \text{ m}^3/\text{hour}$$

$$\text{MLSS} = 3896 \text{ mg/L} = 3.896 \text{ kg/m}^3$$

- (b) Surface area required based on the simplified limiting flux theory

The relevant coefficients, for *fair-poor* settleability, are (see Section 34.3.2-d):

$$v_o = 7.40 \text{ m/hour}; K = 0.59 \text{ m}^3/\text{kg}; m = 7.34; n = 0.71$$

Q/A for the *clarification* criteria:

$$Q/A = v_o \cdot e^{-K \cdot C} = 7.40 \cdot e^{-0.59 \times 3.896} = 0.743 \text{ m/hour}$$

Q/A for the *thickening* criteria:

$$\begin{aligned} Q/A &= \frac{m \cdot [R \cdot v_o \cdot e^{(-K \cdot C_o)}]^n}{(R + 1) \cdot C_o} = \frac{7.34 \cdot [1.0 \times 7.40 \cdot e^{(-0.59 \times 3.896)}]^{0.71}}{(1.0 + 1) \times 3.896} \\ &= 0.763 \text{ m/hour} \end{aligned}$$

Using the smallest of the Q/A values (0.743 m/hour for clarification and 0.763 m/hour for thickening) and knowing that $Q = 409 \text{ m}^3/\text{hour}$:

$$A = 409/0.743 = 550 \text{ m}^2$$

34.3.13 Alternative: circular secondary sedimentation tanks

(a) Diameter

Number of sedimentation tanks to be used: **2**

Area required for each sedimentation tank: $550/2 = 275 \text{ m}^2$

Diameter:

$$D = \sqrt{\frac{4A}{\pi}} = \sqrt{\frac{4 \times 275}{3.14}} = 18.7 \text{ m} \quad \text{Adopt } \mathbf{19.0 \text{ m.}}$$

Resultant area of each sedimentation tank: $A = \pi \cdot D^2/4 = 3.14 \times 19.0^2/4 = 283 \text{ m}^2$

Total resultant area: $2 \times 283 = 566 \text{ m}^2$

(b) Resultant loading rates

- Resultant hydraulic loading rate with Q_{av} : $HLR = Q/A = 409/566 = 0.72 \text{ m}^3/\text{m}^2 \cdot \text{hour}$
- Resultant hydraulic loading rate with Q_{max} : $HLR = Q_{max}/A = 801/566 = 1.42 \text{ m}^3/\text{m}^2 \cdot \text{hour}$
- Resultant solids loading rate with Q_{av} : $SLR = (Q + Q_r) \cdot X/A = (409 + 409) \times 3.896/566 = 5.6 \text{ kgSS}/\text{m}^2 \cdot \text{hour}$
- Resultant solids loading rate with Q_{max} : $SLR = (Q_{max} + Q_r) \cdot X/A = (801 + 409) \times 3.896/566 = 8.3 \text{ kgSS}/\text{m}^2 \cdot \text{hour}$

All the loading rates are within typical ranges reported by Metcalf and Eddy (1991) and WEF/ASCE (1992) (see Table 33.1).

(c) Other dimensions

Sidewater depth (cylindrical part of the tank): **H = 3.5 m** (adopted)

Bottom slope: 8% (= 1/12 vertical/horizontal)

Depth of the conical part of the tank: $H_{\text{cone}} = (D/2) \cdot (\text{slope}/100) = (19.0/2) \times (8/100) = 0.76 \text{ m}$

Volume of each sedimentation tank:

$$V = A \cdot (H + H_{\text{cone}}/3) = 283 \times (3.5 + 0.76/3) = 1,064 \text{ m}^3$$

Total volume of the sedimentation tanks: $2 \times 1,064 = 2,128 \text{ m}^3$

(d) Hydraulic detention time

For average flow + recirculation: $t = V/(Q + Q_r) = 2,128/(409 + 409) = 2.6 \text{ hours}$

For maximum flow + recirculation: $t = V/(Q_{\text{max}} + Q_r) = 2,128/(801 + 409) = 1.7 \text{ hours}$

(e) Effluent weir

Available weir length (for each sedimentation tank; assume that the crest of the weir is 0.5 m from the side wall, into the sedimentation tank):

$$L_{\text{weir}} = \pi \cdot (D - 2 \cdot \text{distance}) = 3.14 \times (19.0 - 2 \times 0.5) = 56.5 \text{ m}$$

Resultant weir loading rate in each of the 2 sedimentation tanks:

For influent Q_{av} : Weir rate = $(Q/2)/L_{\text{weir}} = (409/2)/56.5 = 3.6 \text{ m}^3/\text{m} \cdot \text{hour}$

For influent Q_{max} : Weir rate = $(Q_{\text{max}}/2)/L_{\text{weir}} = (801/2)/56.5 = 7.1 \text{ m}^3/\text{m} \cdot \text{hour}$

These rates are within recommended values (Table 33.7)

34.3.14 Alternative: rectangular secondary sedimentation tanks

Number of sedimentation tanks: 4

Area required for each sedimentation tank: $550/4 = 138 \text{ m}^2$

Dimensions:

Depth: **H = 4.0 m**

Length: **L = 20.0 m**

Width: **B = 6.9 m**

Other calculations: similar approach to the circular sedimentation tanks

34.3.15 Primary sedimentation tanks

The primary sedimentation tanks can be designed based on the loading rates and criteria presented in Section 33.4. The sizing of the tanks is similar to that presented in the current example (Sections 34.3.13 and 34.3.14).

34.4 SUMMARY OF THE DESIGN

Characteristics of the influent

Influent	Characteristic	Item	Value
Raw sewage	Flow (m ³ /d)	Average	9,820
		Maximum	19,212
		Minimum	4,003
	Flow (l/s)	Average	114
		Maximum	222
		Minimum	46
	Average concentration (mg/L)	BOD ₅	341
		TKN	51
		SS	379
	Average load (kg/d)	BOD ₅	3,350
TKN		496	
SS		3,720	
Settled sewage (effluent from primary sedimentation tanks and influent to biological stage)	Average concentration (mg/L)	BOD ₅	239
		TKN	40
		SS	152
	Average load (kg/d)	BOD ₅	2,345
		TKN	397
		SS	1,488

Biological reactors (alternative: mechanical aeration)

Characteristic	Value
<i>Sludge age (d)</i>	6
<i>Adopted MLVSS (mg/L)</i>	3,000
<i>Resultant MLSS (mg/L)</i>	3,896
<i>Dimensions</i>	
• Total volume of the reactors (m ³)	2,051
• Number of reactors (–)	2
• Length (m)	32.0
• Width (m)	8.0
• Depth (m)	4.0
<i>Average detention time (hours)</i>	5.0
<i>Return sludge ratio (–)</i>	1.0
<i>Aeration</i>	
• O ₂ requirements (field) (for Q _{av}) (kgO ₂ /d)	3,258
• O ₂ requirements (field) (for Q _{max}) (kgO ₂ /d)	6,374
• O ₂ requirements (standard) (kgO ₂ /d)	10,449
• Oxygenation efficiency (kgO ₂ /kWh)	1.8
• Required power (HP)	323
• Number of aerators (–)	8
• Power of each aerator (HP)	50
• Total installed power (HP)	400

(Continued)

Characteristic	Value
<i>Excess sludge</i>	
Removal from the reactor	
• Flow (m ³ /d)	426
• Load (kgTSS/d)	1,659
• Concentration (mgTSS/L)	3,896
Removal from the return sludge line	
• Flow (m ³ /d)	213
• Load (kgTSS/d)	1,659
• Concentration (mgTSS/L)	7,792
<i>Estimated concentrations in the final effluent (mg/L)</i>	
BOD ₅	20
SS	30

Secondary sedimentation tanks (alternative: circular sedimentation tanks)

Characteristic	Value
<i>Dimensions</i>	
• Number of sedimentation tanks	2
• Diameter of each sedimentation tank (m)	19.0
• Sidewater depth (m)	3.5
• Depth of the conical part (m)	0.76
• Bottom slope (vertical/horizontal) (%)	8
• Total resultant volume of the sedimentation tanks (m ³)	2.128
<i>Detention times (hour)</i>	
• For Q _{av} + Q _r	2.6
• For Q _{max} + Q _r	1.7
<i>Resultant average loading rates</i>	
• Hydraulic loading rate (m ³ /m ² ·hour)	0.7
• Solids loading rate (kg/m ² ·hour)	5.6
• Weir loading rate (m ³ /m·hour)	3.6

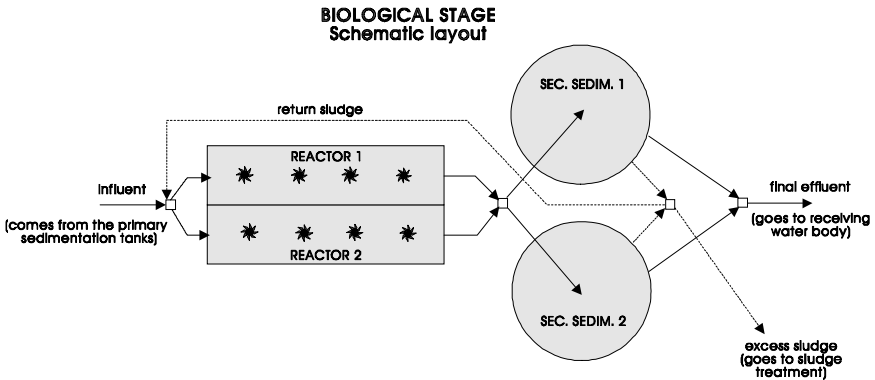

35

Principles of biological nutrient removal

35.1 INTRODUCTION

Biological nutrient removal (BNR) is a topic that is proving increasingly important in the design of activated sludge systems. The nutrients of interest, in this case, are *nitrogen* and *phosphorus*. In many regions, BNR is being used in a systematic way in new projects, and existing treatment plants are being converted to enable the occurrence of BNR.

Naturally, the need or desirability to have nitrogen and phosphorus removal depends on a broader view of the treatment objectives and the final effluent and receiving-body water quality. In *sensitive bodies*, such as lakes, reservoirs and estuaries subject to eutrophication problems, BNR assumes a great importance (see Chapter 3 for the concepts on eutrophication of water bodies). The discharge and water-body standards can influence the decision on whether nutrient removal is needed and to what degree it should be performed.

The European Community's guidelines (CEC, 1991) for discharge into sensitive water bodies, that is, subject to eutrophication, establish the following limits:

Total phosphorus:

- populations between 10,000 and 100,000 inhabitants: concentration of less than 2 mg/L or minimum removal of 80%

- populations above 100,000 inhabitants: concentration of less than 1 mg/L or minimum removal of 80%

Total nitrogen:

- populations between 10,000 and 100,000 inhabitants: concentration of less than 15 mg/L or minimum removal of 70–80%
- population above 100,000 inhabitants: concentration of less than 10 mg/L or minimum removal of 70–80%

When analysing the desirability of incorporating BNR, following a trend observed in more developed countries, a scale of priorities should always be kept in mind. Many of the developed countries have already solved most of the problems of carbonaceous matter (BOD and COD) in their effluents and now need to move to a second stage of priorities, which concerns BNR. In developing countries, there is still the need to solve the basic problems of carbonaceous matter and pathogenic organisms, obviously without losing the perspective of applying, whenever necessary, nutrient removal.

Besides the aspects of the receiving body, the inclusion of intentional nutrient removal can lead to an improvement in the operation of the WWTP. In the case of nitrogen removal, there are savings on oxygen and alkalinity, besides the reduction of the possibility of having rising sludge in the secondary sedimentation tanks.

This chapter focuses on the *basic principles* of the following topics associated with biological nutrient removal:

- *nitrification* (oxidation of ammonia to nitrite and then to nitrate)
- *denitrification* (conversion of nitrate into gaseous nitrogen)
- *phosphorus removal* (biological phosphorus removal)

It should be stressed that nitrification does not result in the removal of nitrogen, but only in a conversion in its form from ammonia to nitrate. Thus, nitrification should be understood as removal of ammonia, but not of nitrogen. Nitrification takes place almost systematically in activated sludge plants operating in warm-climate conditions. Thus, the design should take its occurrence into consideration, mainly in the estimation of the oxygen requirements. The design example presented in Chapter 34 was based on this assumption. In the main conversion route of N, for denitrification to occur, it is necessary that nitrification occurs first (there are other routes not covered in this book).

The accumulated knowledge and operational experience in this area is already high, and the designs can be made with a satisfactory degree of reliability. Presently, research efforts are made mainly to understand the interaction among the various microorganisms involved and how they affect plant operation (e.g., sedimentation), as well as to produce reliable mathematical models for the process, mainly in the case of phosphorus.

The *design of BNR systems* is dealt with in Chapter 36. It should be noted that the aim of this chapter is only to introduce the main aspects of BNR, and not to

discuss it thoroughly, because of the wide amplitude of the theme. The books by Barnes and Bliss (1983), WRC (1984), Sedlak (1991), Randall *et al.* (1992), EPA (1987b, 1993) and Orhon and Artan (1994) and the reports by the International Water Association (IAWPRC, 1987; IAWQ, 1995, IWA, 2000) are excellent and specific literature on biological nutrient removal.

35.2 NITROGEN IN RAW SEWAGE AND MAIN TRANSFORMATIONS IN THE TREATMENT PROCESS

Chapter 2 describes the main characteristics of nitrogen in raw sewage, such as predominant fractions and typical concentrations. This section provides additional information in this respect.

The nitrogen present in raw sewage, as well as the processes that occur in interaction with the biomass, can be characterised as illustrated in Figure 35.1.

SUBDIVISIONS AND TRANSFORMATIONS OF THE NITROGENOUS MATTER

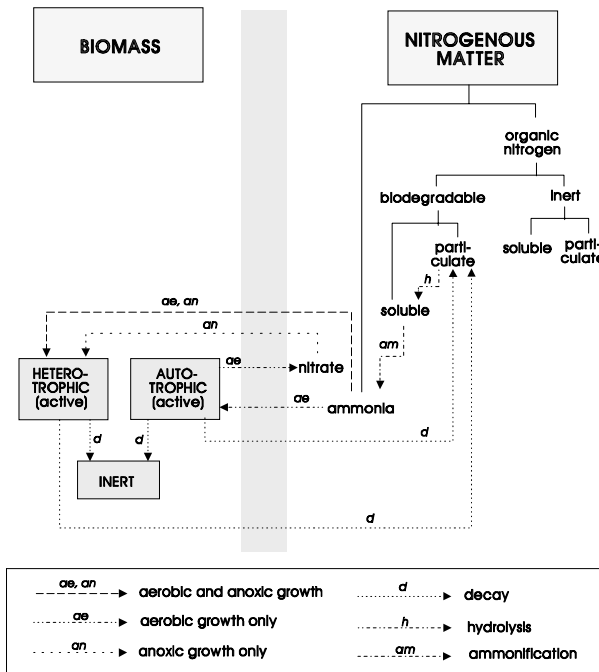

Figure 35.1. Subdivisions and transformations of the nitrogenous matter in the activated sludge process

(a) Characterisation of the nitrogenous matter

- The **inorganic nitrogenous matter** is represented by *ammonia*, both in a free (NH_3) and in an ionised form (NH_4^+). In reality, ammonia is present in the influent wastewater due to the fact that hydrolysis and ammonification reactions begin in the collection and interception sewerage system, as described below. Ammonia is used by the heterotrophic and autotrophic bacteria.
- The **organic nitrogenous matter** is also divided, in a similar way to the carbonaceous matter, into two fractions in terms of its biodegradability: (a) *inert* and (b) *biodegradable*.
 - *Inert*. The inert fraction is divided into two fractions, based on its physical state:
 - *Soluble*. This fraction is usually negligible and can be disregarded.
 - *Particulate*. This fraction is associated with the non-biodegradable carbonaceous organic matter, involved in the biomass and removed with the excess sludge.
 - *Biodegradable*. The biodegradable fraction can be subdivided into the following components:
 - *Rapidly biodegradable*. The quickly biodegradable nitrogenous organic matter is found in a *soluble* form, and is converted by heterotrophic bacteria into ammonia, through the process of ammonification.
 - *Slowly biodegradable*. The slowly biodegradable nitrogenous organic matter is found in a *particulate* form, being converted into a soluble form (quickly biodegradable) through *hydrolysis*. This hydrolysis takes place in parallel with the hydrolysis of the carbonaceous matter.

(b) Characterisation of the biomass

The **active biomass** is responsible for the biological degradation. In terms of the carbon source, the biomass can be divided into (a) *heterotrophic* and (b) *autotrophic* (see Chapter 7):

- *Heterotrophic active biomass*. The source of carbon of the heterotrophic organisms is the carbonaceous organic matter. The heterotrophic biomass uses the rapidly biodegradable soluble carbonaceous matter. Part of the energy associated with the molecules is incorporated into the biomass, while the rest is used to supply the energy for synthesis. In aerobic treatment, the growth of the heterotrophic biomass occurs in aerobic (use of oxygen as electron acceptors, see Chapter 7) or anoxic (absence of oxygen, with the use of nitrate as electron acceptors) conditions. This growth is very low in anaerobic conditions (absence of oxygen and nitrate). Heterotrophic bacteria use the nitrogen in the form of ammonia for synthesis (in aerobic and anoxic conditions) and the nitrogen in the form of

nitrate as an electron acceptor (in anoxic conditions). The decay of the heterotrophic biomass also generates, besides the inert residue, carbonaceous and nitrogenous matter of slow degradation. This material needs to subsequently undergo a hydrolysis process to become a rapidly biodegradable matter, which can be used again by the heterotrophic and autotrophic biomass.

- *Autotrophic active biomass.* The source of carbon for the autotrophic organisms is carbon dioxide. The autotrophic biomass uses ammonia as an energy source (they are chemoautotrophic organisms, that is, that use *inorganic* material as an energy source). Under aerobic conditions, these bacteria use ammonia in the nitrification process, in which ammonia is converted into nitrite and subsequently into nitrate. Similar to that for the heterotrophic organisms, the decay of the autotrophic biomass also generates, besides the inert residue, carbonaceous and nitrogenous matter of slow degradation. This material needs to subsequently undergo a hydrolysis process to become a rapidly biodegradable material, which can be used again by the heterotrophic and autotrophic biomass.

The **inert residue** is formed by the decay of the biomass involved in the wastewater treatment. Biomass decay can occur by the action of several mechanisms, which include endogenous metabolism, death, predation and others. As a result, products of slow degradation are generated, as well as particulate products, which are inert to biological attack.

As mentioned, the microorganisms involved in the **nitrification** process are *chemoautotrophs*, for which carbon dioxide is the main source of carbon, and energy is obtained through the oxidation of an inorganic substrate, such as ammonia, into mineralised forms.

The transformation of ammonia into nitrites is accomplished by bacteria, such as those from the genus *Nitrosomonas*, according to the following reaction:

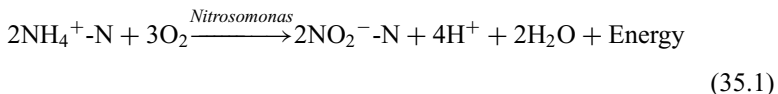

The oxidation of nitrites into nitrates occurs by the action of bacteria, such as those from the genus *Nitrobacter*, expressed by:

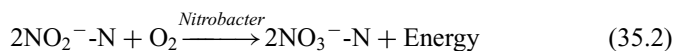

The **overall nitrification reaction** is the sum of Equations 35.1 and 35.2:

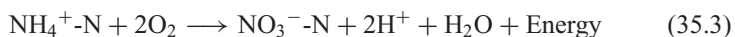

In reactions 35.1 and 35.2 (as well as in the overall reaction 35.3), the following points should be noted:

- *consumption of oxygen*. This consumption is generally referred to as *nitrogenous demand*
- *release of H^+* , consuming the alkalinity of the medium and possibly reducing the pH

The energy liberated in these reactions is used by the nitrifying microorganisms in the synthesis of organic compounds from inorganic carbon sources, such as carbon dioxide, bicarbonate and carbonate. Therefore, nitrification is intimately associated with the growth of nitrifying bacteria (Barnes and Bliss, 1983).

The growth rate of the nitrifying microorganisms, mainly *Nitrosomonas*, is very slow, and much lower than that of the microorganisms responsible for the conversion of the carbonaceous matter. Thus, in a biological treatment system where nitrification is desired, the mean cell residence time, or sludge age, should be such that it enables the development of the nitrifying bacteria, before they are washed out from the system. The system is controlled, therefore, by the organism with the slowest growth rate, in this case, *Nitrosomonas*. The bacteria of the *Nitrobacter* genus have a faster growth rate and, for this reason, there is practically no accumulation of nitrites in the system.

In anoxic conditions (absence of oxygen but presence of nitrates), the nitrates are used by heterotrophic microorganisms as electron acceptors, as a replacement for oxygen. In this process named **denitrification**, the *nitrate is reduced to gaseous nitrogen*, according to the following reaction:

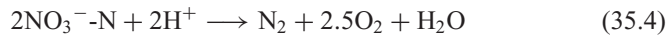

In the denitrification reaction the following should be noted:

- *economy of oxygen* (the organic matter can be stabilised in the absence of oxygen)
- *consumption of H^+* , implying savings in alkalinity and an increase in the buffer capacity of the medium

When representing stoichiometric relations, the difference between, for example, NH_4^+ and $\text{NH}_4^+ - \text{N}$, should be clearly distinguished. The first form expresses the concentration of the ammonium ion, while the second represents the nitrogen in the form of the ammonium ion. The molecular weights vary, as shown below:

NH_4^+ : molecular weight = 18 g/mol

$\text{NH}_4^+ - \text{N}$: molecular weight = 14 g/mol (= molecular weight of N)

The second form is more convenient because it allows comparisons among relations, based always on nitrogen, irrespective of whether it is in the organic, ammonia, nitrite or nitrate forms. In this book, including the equations and chemical reactions, the use of the second concept is implied, that is, the nitrogen forms are expressed, in terms of mass, as nitrogen.

35.3 PRINCIPLES OF NITRIFICATION

35.3.1 Kinetics of nitrification

The growth rate of the nitrifying bacteria can be expressed in terms of Monod's relation as follows:

$$\mu = \mu_{\max} \cdot \left[\frac{\text{NH}_4^+}{K_N + \text{NH}_4^+} \right] \quad (35.5)$$

where:

- μ = specific growth rate of the nitrifying bacteria (d^{-1})
- μ_{\max} = maximum specific growth rate of the nitrifying bacteria (d^{-1})
- NH_4^+ = ammonia concentration, expressed in terms of nitrogen (mg/L)
- K_N = half-saturation constant (mg/L)

For further details concerning Monod's kinetics, see Chapter 8. For simplification purposes in the model structure, nitrification is assumed to take place in a single stage (ammonia-nitrate), instead of two stages (ammonia-nitrite, nitrite-nitrate). Typical values of the kinetic and stoichiometric coefficients for the unified nitrifying biomass are shown in Table 35.1.

The value of K_O (oxygen) in Table 35.1 can be explained by the fact that oxygen is also a limiting factor in the growth of nitrifying bacteria, and could also be expressed by Monod's relation (see Section 35.3.2.c). θ is the temperature coefficient for the correction of the growth rate of the nitrifying bacteria (see Section 35.3.2.a). Y_N is the yield coefficient, which indicates the mass of nitrifying bacteria that is produced per unit mass of ammonia used (see Section 35.3.4). K_d is the bacterial decay coefficient and is frequently ignored in modelling, because of its low value and the fact that most of the growth rates reported in the literature have been calculated without taking K_d into account (Randall *et al.*, 1992; EPA, 1993).

Frequently, ammonia is replaced in stoichiometric relations by TKN (total Kjeldahl nitrogen), assuming that the organic nitrogen will be transformed into

Table 35.1. Typical values of the kinetic and stoichiometric coefficients for nitrification (unified nitrifying biomass)

Coefficient	Unit	Wider range	Typical range or value
μ_{\max} (20 °C)	d^{-1}	0.3–2.2	0.3–0.7
K_N (ammonia)	mgNH_4^+/L	0.1–5.6	0.5–1.0
K_O (oxygen)	mgO_2/L	0.3–2.0	0.4–1.0
θ	–	1.08–1.13	1.10
Y_N	$\text{mg cells}/\text{mgNH}_4^+$ oxidised	0.03–0.13	0.05–0.10
K_d	d^{-1}	0.04–0.16	≈ 0

Source: Arceivala (1981), Barnes and Bliss (1983), Sedlak (1991), Randall *et al.* (1992), EPA (1993) and Orhon and Artan (1994)

ammonia in the treatment line and that, for this reason, the influent TKN will be a good representation of the ammonia available for the nitrifying bacteria. The conversion of organic nitrogen into ammonia is nearly total, even with reduced sludge ages. This adaptation is used mainly when calculating oxygen (Section 35.3.5) and alkalinity (Section 35.3.6) requirements, leading to safer estimates.

Example 35.1

Calculate the growth rate of the nitrifying bacteria in a complete-mix reactor based on the following data:

- Desired effluent TKN = 2.0 mg/L (this concentration will also be prevalent in the whole reactor, since there are complete-mix conditions)
- $\mu_{\max} = 0.5 \text{ d}^{-1}$ (adopted – Table 35.1)
- $K_N = 0.7 \text{ mg/L}$ (adopted – Table 35.1)

Solution:

According to Equation 35.5, the growth rate of the nitrifying bacteria, under ideal conditions and at a temperature of 20 °C, is:

$$\mu = \mu_{\max} \cdot \left[\frac{\text{NH}_4^+}{K_N + \text{NH}_4^+} \right] = 0.5 \cdot \left[\frac{2.0}{0.7 + 2.0} \right] = 0.37 \text{ d}^{-1}$$

Thus, the specific growth rate with the TKN concentration in the reactor of 2.0 mg/L is 0.37 d^{-1} . If the TKN in the reactor were still lower, for example 1.0 mg/L, μ would be still more reduced, and reach 0.29 d^{-1} . The lower the μ , the greater the sludge age should be, so that the nitrifying organisms would have conditions to develop without being washed out from the system. In this example, an arbitrary concentration of effluent TKN was selected, without taking into consideration the influent TKN. The removal of TKN according to the operational conditions in the reactor is discussed in Section 35.3.4.

35.3.2 Environmental factors of influence on nitrification

The following environmental factors influence the growth rate of the nitrifying organisms and, as a consequence, the oxidation rate of ammonia:

- temperature
- pH
- dissolved oxygen
- toxic or inhibiting substances

(a) Temperature

Temperature significantly affects the maximum growth rate (μ_{\max}) of the nitrifying organisms. According to Downing (1978), the effect of temperature can be

described as follows:

$$\mu_{\max(T)} = \mu_{\max(20^\circ\text{C})} \cdot \theta^{(T-20)} \quad (35.6)$$

where:

$$\begin{aligned} \mu_{\max(T)} &= \text{maximum growth rate at a temperature } T \text{ (d}^{-1}\text{)} \\ \theta &= \text{temperature coefficient} \\ T &= \text{temperature (}^\circ\text{C)} \end{aligned}$$

The temperature coefficient θ is reported in a range from 1.08 to 1.13, and the value of 1.10, supported by a large number of data, seems reasonable (Barnes and Bliss, 1983). Thus, for each increment of approximately 7°C in the temperature, the growth rate doubles and, conversely, each drop of 7°C implies a reduction in the growth rate by half.

The half-saturation coefficients K_N and K_O also increase with an increase in temperature, although the data available in the literature are not conclusive. EPA (1993) and Orhon and Artan (1994) suggest adopting a constant value for the half-saturation coefficients, irrespective of the temperature.

The occurrence of nitrification was observed in a range from 5 to 50°C , but the optimal temperature is in the order of 25 to 36°C (Arceivala, 1981; Barnes and Bliss, 1983).

(b) pH

According to Downing (1978), the nitrification rate is at its optimal and approximately constant in the pH range from 7.2 to 8.0. Below 7.2, μ_{\max} decreases with pH according to the following relation:

$$\mu_{\max(\text{pH})} = \mu_{\max}[1 - 0.83(7.2 - \text{pH})] \quad (35.7)$$

where:

$$\begin{aligned} \mu_{\max(\text{pH})} &= \text{maximum growth rate of the nitrifying bacteria for a given pH (d}^{-1}\text{)} \\ \mu_{\max} &= \text{maximum growth rate of the nitrifying bacteria at a pH of 7.2 (d}^{-1}\text{)} \end{aligned}$$

Equation 35.7 has a validity range of pH from 6.0 to 7.2. For a stable performance, it is advisable to maintain the pH in the range from 6.5 to 8.0 (EPA, 1993).

It is important to know that nitrification is responsible for the decrease of pH and generates H^+ as a final product (see Equation 35.3 and Section 35.3.6). The decrease of the pH is a function of the buffer capacity of the medium or, in other words, of its alkalinity. This aspect can be of great importance for the adequate nitrification performance in an activated sludge system.

(c) Dissolved oxygen

Dissolved oxygen in the reactor is an indispensable pre-requisite for the occurrence of nitrification. It seems that the critical DO concentration, below which no

nitrification is expected to occur, is around 0.2 mg/L (Barnes and Bliss, 1983). However, higher values should be maintained in the aeration tank to ensure that, in points where oxygen access is more difficult, such as inside the activated sludge flocs, a higher than critical concentration is maintained. Downing (1978) recommends that the DO concentration in the reactor should not be reduced to less than 0.5 mg/L. However, EPA (1993) recommends that a minimum DO of 2.0 mg/L is specified to avoid problems with the influent ammonia peaks.

The effect of the DO concentration on the specific growth rate can also be represented by Monod's kinetics, as follows:

$$\mu = \mu_{\max} \cdot \left[\frac{\text{DO}}{K_{\text{O}} + \text{DO}} \right] \quad (35.8)$$

where:

DO = dissolved oxygen concentration in the reactor (mg/L)

K_{O} = half-saturation constant for oxygen (mg/L) (see Table 35.1)

The presence of oxygen is more important to nitrification than it is to the removal of carbonaceous matter. In the removal of the carbonaceous matter, the absorption phase, which precedes metabolism, can store energy in some way until oxygen becomes available again. In contrast, nitrification ceases the moment oxygen is reduced below the critical level. On the other hand, nitrification resumes very fast as soon as DO rises.

(d) Toxic or inhibiting substances

Toxic substances can seriously inhibit the growth of nitrifying bacteria, mainly *Nitrosomonas*, which are more sensitive. A large list of inhibiting substances and products, expressed in terms of the percentage inhibition that they cause, is known. The references Sedlak (1991), Randall *et al.* (1992) and EPA (1993) provide lists including several of these compounds.

One of the aspects to be analysed in the planning of a WWTP receiving industrial effluent is the possible influence of these on nitrification. A pre-treatment in the industry may be often necessary.

Example 35.2

Calculate the specific growth rate of the nitrifying bacteria, according to the data from Example 35.1 ($\mu_{\max} = 0.5 \text{ d}^{-1}$), and under the following environmental conditions:

- temperature: $T = 20 \text{ }^{\circ}\text{C}$
- pH = 6.9
- DO = 2.0 mg/L
- absence of toxic or inhibiting substances

Example 35.2 (Continued)**Solution:**

(a) Effect of ammonia concentration

$$\mu_{\max} = 0.50 \text{ d}^{-1}$$

$$\mu = 0.37 \text{ d}^{-1} \text{ (calculated in Example 35.1)}$$

$$\mu_{\max} \text{ correction factor} = 0.37/0.50 = 0.74 \text{ (reduction of 26\%)}$$

(b) Temperature

According to Equation 35.6 and using $\theta = 1.10$:

$$\mu_{\max(T)} = \mu_{\max(20^\circ\text{C})} \cdot \theta^{(20-20)} = 0.50 \times 1.10^{(20-20)} = 0.50 \text{ d}^{-1}$$

μ_{\max} correction factor = $0.50/0.50 = 1.00$ (reduction of 0%) (unchanged, because the temperature is the same as the standard temperature)

(c) pH

According to Equation 35.7:

$$\begin{aligned} \mu_{\max(\text{pH})} &= \mu_{\max} [1 - 0.83 (7.2 - \text{pH})] = 0.5 \times [1 - 0.83 \times (7.2 - 6.9)] \\ &= 0.38 \end{aligned}$$

$$\mu_{\max} \text{ correction factor} = 0.38/0.50 = 0.76 \text{ (reduction of 24\%)}$$

(d) Dissolved oxygen

According to Equation 35.8 and Table 35.1:

$$\mu = \mu_{\max} \cdot \left[\frac{\text{DO}}{K_O + \text{DO}} \right] = 0.5 \cdot \left[\frac{2.0}{0.6 + 2.0} \right] = 0.38$$

$$\mu_{\max} \text{ correction factor} = 0.38/0.50 = 0.76 \text{ (reduction of 24\%)}$$

(e) Combined effect of the environmental conditions

Multiple correction factor:

$$0.74 \times 1.00 \times 0.76 \times 0.76 = 0.43$$

The specific growth rate of the nitrifying bacteria under these environmental conditions is 43% of the maximum rate ($\mu = 0.43\mu_{\max}$). Under these environmental conditions, μ is:

$$\mu = 0.43 \times \mu_{\max} = 0.43 \times 0.50 = 0.22 \text{ d}^{-1}$$

Table 35.2. Minimum sludge age required for nitrification

Temperature of the liquid in the reactor (°C)	Minimum θ_c for complete nitrification (days)
5	12
10	9.5
15	6.5
20	3.5

Source: Arceivala (1981)

35.3.3 Sludge age required for nitrification

As mentioned, the reproduction rate of the nitrifying organisms is much smaller than that of the heterotrophic organisms responsible for the stabilisation of the carbonaceous matter. This suggests that the concept of sludge age is extremely important for nitrification to be achieved in the activated sludge process.

Nitrification will happen if the sludge age is such that it will allow the development of the nitrifying bacteria before they are washed out of the system. As seen in Chapter 9, the sludge age is the reciprocal of the specific growth rate in an activated sludge system in equilibrium ($\theta_c = 1/\mu$). As the growth rate of the nitrifying bacteria is lower than that of the heterotrophic bacteria, the sludge age should be equal to or higher than the reciprocal of their growth rate to allow the nitrifying bacteria to develop, that is:

$$\theta_c \geq \frac{1}{\mu_N} \quad (35.9)$$

Thus, if the specific growth rate of the nitrifying bacteria is known, a minimum sludge age can be established to ensure proper nitrification.

Arceivala (1981) proposes that, for sewage without any specific inhibiting factors, the minimum sludge age values presented in Table 35.2 should be considered.

The required sludge age can also be calculated, if data are available, based on the value of μ determined according to the prevalent environmental conditions in the reactor, as described in the previous section and illustrated in Example 35.3.

Some authors still recommend including a safety factor in the order of 1.5 to 2.5 to cover the peaks in influent ammonia load and other unexpected environmental variations.

Example 35.3

Calculate the minimum sludge age required for nitrification to occur in the system described in Example 35.2. Data: $\mu = 0.22 \text{ d}^{-1}$ (as calculated in Example 35.2).

Solution:

According to Equation 35.9:

$$\theta_c \geq \frac{1}{\mu_N} = \frac{1}{0.22} = 4.5 \text{ d}$$

Example 35.3 (Continued)

Thus, a minimum sludge age of 4.5 days is required to ensure full nitrification. With a design safety factor of 1.5, the recommended sludge age will be $4.5 \times 1.5 = 6.8$ days.

For comparison purposes, if the temperature of the liquid were 10 °C (common in temperate-climate countries), the correction factor for the temperature would decrease from 1.00 (see Example 35.2) to 0.39. The overall correction factor would be 0.17 and the specific growth rate $0.5 \times 0.17 = 0.09 \text{ d}^{-1}$. In these environmental conditions, the minimum sludge age required would be $1/0.09 = 11.1$ days, which, with a design safety factor of 1.5, would rise to 16.7 days. The great influence of a non-controllable variable, such as the temperature, on nitrification is observed, thus requiring larger sludge ages in cold climates. In tropical countries, the high temperatures greatly facilitate nitrification, which takes place almost systematically, even in conventional activated sludge systems, with a reduced sludge age.

35.3.4 Nitrification rate

Once the growth of the nitrifying bacteria is ensured by using a satisfactory sludge age based on the specific growth rate, it becomes necessary to calculate the nitrification rate, that is, the rate at which ammonia is converted into nitrate. The nitrification rate is a function of the mass of nitrifying organisms present in the aerated zones of the reactor and can be expressed as follows:

$\Delta \text{TKN} / \Delta t = (\text{unitary nitrification rate}) \times (\text{concentration of nitrifying bacteria})$

$$\frac{\Delta \text{TKN}}{\Delta t} = \left(\frac{\mu_{\text{N}}}{Y_{\text{N}}} \right) \cdot X_{\text{N}} \quad (35.10)$$

where:

$\Delta \text{TKN} / \Delta t =$ nitrification rate (oxidised gTKN/m³·d)

$\mu_{\text{N}} =$ specific growth rate of the nitrifying bacteria, determined based on μ_{max} and the environmental conditions (d⁻¹)

$Y_{\text{N}} =$ yield coefficient of the nitrifying bacteria (gX_N/gTKN)

$X_{\text{N}} =$ concentration of the nitrifying bacteria in the aerated zones of the reactor (g/m³)

Usually, it is preferable to express the concentration of the nitrifying bacteria in terms of the volatile suspended solids in the reactor. Therefore, it is necessary to determine which fraction of VSS is represented by the nitrifying bacteria. The fraction of nitrifying bacteria in the VSS (f_{N}) can be estimated through the relation

between the growth rates (Barnes and Bliss, 1983):

$$f_N = \frac{\text{growth rate of nitrifying bacteria (gX}_N\text{/m}^3\cdot\text{d)}}{\text{growth rate of the total biomass (heterotrophs and nitrifiers) (gVSS/m}^3\cdot\text{d)}}$$

$$f_N = \frac{\Delta X_N / \Delta t}{\Delta X_V / \Delta t} \quad (35.11)$$

The denominator of Equation 35.11 is the VSS production (P_{X_V}) and can be calculated by:

$$\frac{\Delta X_V}{\Delta t} = \frac{X_V}{\theta_c} \quad (35.12)$$

The numerator of Equation 35.11, relative to the production of the mass of nitrifying bacteria, can be expressed as:

$$\frac{\Delta X_N}{\Delta t} = Y_N \cdot [\text{TKN}_{\text{removed}} - \text{TKN}_{\text{incorporated in excess sludge}}] = Y_N \cdot \text{TKN}_{\text{oxidised}} \quad (35.13)$$

The yield coefficient (Y_N) can be obtained from Table 35.1.

The fraction of TKN incorporated into the excess sludge is 12% of the VSS mass produced per day (N is 12% in mass of the composition of the bacterial cell, represented by $C_5H_7NO_2$; molecular weight of N = 14 g/mol; molecular weight of $C_5H_7NO_2 = 5 \times 12 + 7 \times 1 + 1 \times 14 + 2 \times 16 = 113$ g/mol; $14/113 = 0.12 = 12\%$). In Section 31.17 (*Nutrient Requirements*), a more advanced formula is presented for the estimation of the TKN fraction in the excess sludge, and the value of 10% was used in the example of Chapter 34. The three approaches lead to similar results. For the purposes of this section, the value of 12% is used.

The TKN to be removed corresponds to the product of the flowrate multiplied by the difference between the influent and effluent TKN. Thus, Equation 35.11 can be finally presented as follows:

$$f_N = \frac{Y_N \cdot [Q \cdot (\text{TKN}_o - \text{TKN}_e) - 0.12 \cdot V \cdot (\Delta X_V / \Delta t)]}{V \cdot (\Delta X_V / \Delta t)} \quad (35.14)$$

where:

Q = influent flow (m^3/d)

TKN_o = influent TKN to the reactor (g/m^3)

TKN_e = effluent TKN from the reactor (g/m^3)

V = total volume of the reactor (m^3)

Once the fraction f_N is known, the mass of nitrifying bacteria can be expressed in terms of the total biomass (X_V).

The **nitrification rate** can then be expressed as follows:

$$\frac{\Delta \text{TKN}}{\Delta t} = f_N \cdot \frac{X_V \cdot \mu_N}{Y_N} \quad (\text{g/m}^3 \cdot \text{d}) \quad (35.15)$$

The **TKN load oxidised per day** is:

$$L_{\text{TKN}} = \frac{V_{\text{aer}}}{10^3} \cdot \frac{\Delta \text{TKN}}{\Delta t} \quad (\text{kg/d}) \quad (35.16)$$

where:

L_{TKN} = load of oxidised TKN (kg/d)

V_{aer} = volume of the aerated zone of the reactor (m^3)

Example 35.4

Calculate the nitrification rate based on the conventional activated sludge system data provided in the example of Chapter 34 and on the environmental conditions of Examples 35.1 and 35.2, that is:

- $Q = 9,820 \text{ m}^3/\text{d}$
- $V = 2,051 \text{ m}^3$
- $V_{\text{aer}} = 2,051 \text{ m}^3/\text{d}$ (the reactor is totally aerobic without anoxic zones)
- $\theta_c = 6 \text{ d}$
- $X_V = 3,000 \text{ g/m}^3$
- Influent TKN to the reactor = 40 g/m^3 (after the primary sedimentation tank, where a removal of 20% was assumed)
- Effluent TKN = 2 g/m^3 (desired)
- $T = 20 \text{ }^\circ\text{C}$
- $\mu = 0.22\text{d}^{-1}$ (calculated in Example 35.2)
- $Y_N = 0.08 \text{ gX}_N/\text{gX}_V$ (Table 35.1)

Solution:

(a) Analysis of the sludge age

Considering the environmental conditions of Examples 35.1 and 35.2, the minimum sludge age required for nitrification is 4.5 d (as calculated in Example 35.3). In this example, θ_c is equal to 6 d, which ensures the development of nitrifying bacteria. The safety factor for the sludge age is $6.0/4.5 = 1.33$.

(b) Production of solids

The production of VSS in the reactor ($\Delta X_V/\Delta t$), even though it has already been determined in the example of Chapter 34, can be calculated using Equation 35.13:

$$\frac{\Delta X_V}{\Delta t} = \frac{X_V}{\theta_c} = \frac{3,000}{6} = 500 \text{ gVSS/m}^3 \cdot \text{d}$$

Example 35.4 (Continued)

The load of VSS produced is:

$$P_{XV} = (500 \text{ gVSS/m}^3 \cdot \text{d}) \times (2051 \text{ m}^3) = 1,025,500 \text{ gVSS/d}$$

(c) Fraction of nitrifying bacteria f_N

$$\text{TKN to be removed} = Q \cdot (\text{TKN}_o - \text{TKN}_e) = 9820 \times (40 - 2) = 373,160 \text{ g/d}$$

$$\begin{aligned} \text{TKN incorporated into the excess sludge} &= 0.12 \cdot V \cdot (\Delta X_V / \Delta t) \\ &= 0.12 \times 2051 \times 500 = 123,060 \text{ g/d} \end{aligned}$$

$$\text{TKN to be oxidised} = 373,160 - 123,060 = 250,100 \text{ g/d}$$

According to Equation 35.13, the production of nitrifying bacteria is:

$$\Delta X_N / \Delta t = Y_N \cdot \text{TKN}_{\text{oxidised}} = 0.08 \times 250,100 = 20,008 \text{ gX}_N / \text{d}$$

The fraction f_N can then be calculated as the quotient between the production of X_N and the production of X_V (Equation 35.11):

$$f_N = \frac{20,008}{1,025,500} = 0.020 \text{ gX}_N / \text{gX}_V$$

The fraction f_N can also be calculated directly using Equation 35.14:

$$\begin{aligned} f_N &= \frac{Y_N \cdot [Q \cdot (\text{TKN}_o - \text{TKN}_e) - 0.12 \cdot V \cdot (\Delta X_V / \Delta t)]}{V \cdot (\Delta X_V / \Delta t)} \\ &= \frac{0.08 \times [9,820 \times (40 - 2) - 0.12 \times 2,051 \times 500]}{2,051 \times 500} \\ &= \frac{0.08 \times (373,160 - 123,060)}{1,025,500} = \frac{20,008}{1,025,500} \\ &= 0.020 \text{ gX}_N / \text{gX}_V \end{aligned}$$

In this case, the nitrifying bacteria represent 2.0% of the total biomass (expressed as volatile suspended solids).

(d) Nitrification rate

According to Equation 35.15, the nitrification rate is given by:

$$\frac{\Delta \text{TKN}}{\Delta t} = f_N \cdot \frac{X_V \cdot \mu_N}{Y_N} = 0.020 \times \frac{3,000 \times 0.22}{0.08} = 165 \text{ gTKN/m}^3 \cdot \text{d}$$

Example 35.4 (Continued)

The TKN load capable of being oxidised is (Equation 35.16):

$$L_{\text{TKN}} = \frac{V_{\text{aer}}}{10^3} \cdot \frac{\Delta \text{TKN}}{\Delta t} = \frac{2,051}{1,000} \times 165 = 338 \text{ kgTKN/d}$$

(e) Comments

In the conditions assumed, the TKN load capable of being oxidised in the system (nitrification capacity) is 338 kg/d, much higher than the load available to be oxidised, which is 250 kg/d (see item (c)). Thus, nitrification will be complete, all the available load will be oxidised and the TKN effluent concentration is expected to be less than 2 g/m³, which was initially assumed. Given the degree of uncertainty in several design input data and considering that 2 g/m³ is already sufficiently low and close to zero, there is no need to redo the calculations, for a new lower effluent TKN concentration.

In summary, the mass balance is:

- TKN load to be removed: 373 kg/d
- TKN load incorporated into the excess sludge: 123 kg/d
- TKN load oxidised (nitrified): 250 kg/d

If the nitrification capacity was smaller than the load to be oxidised, the non-removed load should be calculated and, accordingly, the effluent concentration. For example, if the load capable of being oxidised (L_{TKN}) were 150 kg/d, the non-oxidised load would be: 250 – 150 = 100 kg/d. For a flow rate of 9,820 m³/d, the effluent concentration would be 100/9,820 = 0.010 kgTKN/m³ = 10 gTKN/m³. Since this value is much higher than the 2 g/m³ initially assumed, the μ growth rate calculations in Examples 35.1, 35.2, 35.3 and 35.4 should be redone until a satisfactory convergence is obtained.

In extended aeration systems, due to the larger sludge age, the sludge production is lower and the withdrawal route of TKN in the excess sludge is also smaller. On the other hand, the nitrification capacity can be higher due to the larger sludge age.

35.3.5 Oxygen requirements for nitrification

From the overall nitrification reaction (Equation 35.3), it can be seen that 1 mol of ammonia-N requires 2 moles of oxygen for its oxidation, that is, 4.57 kgO₂ are required for 1 kg of N (MW of N = 14 g/mol; MW of O₂ = 64 g/mol; 64/14 = 4.57). In summary:

oxidation of 1 mgNH₄⁺-N/L consumes 4.57 mgO₂/L

The O_2 required for the nitrification in an activated sludge system is therefore:

$$O_{2 \text{ required}} (\text{kgO}_2/\text{d}) = 4.57 (\text{kgO}_2/\text{kgTKN}) \times \text{TKN}_{\text{oxidised}} (\text{kgTKN}/\text{d}) \quad (35.17)$$

The determination of the load of oxidised TKN was discussed in Section 35.3.4.

In the design example of Chapter 34 it was assumed for simplicity that the load of influent TKN would be totally oxidised. This was done due to the fact that the concepts of nitrification had still not been introduced in that chapter. However, the approach described in this section is preferable and should be adopted.

In terms of demand, the O_2 consumption for nitrification corresponds to a significant fraction of the overall oxygen requirement, which includes the oxidation of the carbonaceous and nitrogenous material.

Example 35.5

Calculate the O_2 requirements for nitrification based on the data included in Example 35.4. The relevant data are: oxidised TKN = 250 kg/d.

Solution:

According to Equation 35.17:

$$\begin{aligned} O_{2 \text{ required}} (\text{kgO}_2/\text{d}) &= 4.57 (\text{kgO}_2/\text{kgTKN}) \times \text{TKN}_{\text{oxidised}} (\text{kgTKN}/\text{d}) \\ &= 4.57 \times 250 = 1,143 \text{ kgO}_2/\text{d} \end{aligned}$$

For comparison purposes, the value calculated in the example in Chapter 34, for conventional activated sludge, was 1,344 kgO_2/d , 18% higher than the value calculated in this example. The preferable value to be adopted is that in this example (1,143 kgO_2/d), since it has been calculated using a method that takes into consideration a larger number of interacting factors. In the examples in question, the difference in the **overall** O_2 requirements according to the two approaches is, however, small (7%).

35.3.6 Alkalinity requirements for nitrification

When analysing the overall nitrification reaction (Equation 35.3), it is observed that:

oxidation of 1 mol of $\text{NH}_4^+\text{-N}$ produces 2 moles of H^+

It is known that in sewage, due to the presence of alkalinity, H^+ will not generate acidity directly, and the buffering bicarbonate – carbon dioxide system will be activated:



Thus, each mol of H^+ consumes 1 mol of HCO_3^- (bicarbonate). Therefore, the 2 moles of H^+ generated in nitrification will consume 2 moles of HCO_3^- , that is, in the end, the oxidation of 1 mol of NH_4^+ implies the consumption of 2 moles of HCO_3^- . In terms of concentration, one has:

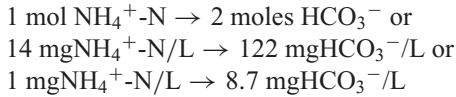

Alkalinity is given by (Schipper, 1981):

$$\text{alkalinity} = 100 \cdot \left\{ [CO_3^{2-}] + \frac{1}{2} [HCO_3^-] + \frac{1}{2} [OH^-] \right\} \quad (35.19)$$

(concentrations in millimoles)

In the usual pH range, the terms corresponding to OH^- and CO_3^{2-} may be ignored. Hence, the alkalinity, after conversion to mg/L, is simply given by:

$$\text{alkalinity} = \frac{HCO_3^-}{1.2} \quad (35.20)$$

where:

HCO_3^- = bicarbonate concentration (mg/L)

Consequently, 8.7 mg HCO_3^- /L corresponds to $8.7/1.2 = 7.1$ mg/L of alkalinity. In other words:

oxidation of 1 mg $NH_4^+ - N/L$ consumes 7.1 mg/L of alkalinity

The decrease in alkalinity and, as a result, the decrease in the buffer capacity of the mixed liquor favour subsequent pH reductions. The consequence of this, which justifies this whole analysis, is that the nitrification rate will be reduced, as it is dependent on pH (see Section 35.3.2.b). Depending on the alkalinity of the raw sewage, it may be necessary to add some alkaline agent (100 mg $CaCO_3/L$ of alkalinity are equivalent to 74 mg/L of $Ca(OH)_2$ – hydrated lime). The alkalinity usually available in raw sewage is in the order of 100 to 250 mg $CaCO_3/L$ (see Chapter 2).

Example 35.6

Calculate the alkalinity requirements based on data from Example 35.4. Assume that the alkalinity of the raw sewage is 150 mg/L. Other relevant data are:

Oxidised TKN = 250 kg/d

Average inflow rate: $Q = 9,820 \text{ m}^3/\text{d}$

Example 35.6 (Continued)**Solution:****(a) Alkalinity requirements**

Knowing that 1 mgTKN/L implies a consumption of 7.1 mg/L of alkalinity, the alkalinity load required is:

$$\text{alkalinity load required} = 7.1 \frac{\text{kg alkalinity}}{\text{kgTKN}} \times 250 \frac{\text{kgTKN}}{\text{d}} = 1,775 \text{ kgCaCO}_3/\text{d}$$

(b) Available alkalinity in the influent

The available alkalinity load in the influent is:

$$\text{available alkalinity load} = 9,820 \frac{\text{m}^3}{\text{d}} \times 150 \frac{\text{g}}{\text{m}^3} \times \frac{1}{10^3} \frac{\text{kg}}{\text{g}} = 1,473 \text{ kgCaCO}_3/\text{d}$$

(c) Comments

The available alkalinity load is lower than that required, and there is a deficit of $1,775 - 1,473 = 302 \text{ kgCaCO}_3/\text{day}$. This will lead to a reduction in the nitrification rate, due to the resulting decline in the pH. For this reason, nitrification may not be complete, which will in its turn result in a decrease in the required alkalinity load, with a point of balance being reached.

If nitrification is to be achieved according to the conditions specified in the previous examples, there are two possible solutions: (a) to stimulate denitrification to take place in the system to reduce alkalinity requirements (see Section 35.4.2) or (b) to add an alkaline agent, lime for instance.

If lime is added, the consumption will be (knowing that 100 mgCaCO₃/L of alkalinity is equivalent to 74 mg/L of Ca(OH)₂ – hydrated lime):

$$\begin{aligned} \text{lime consumption} &= \frac{74 \text{ kgCa(OH)}_2}{100 \text{ kgCaCO}_3} \times 302 \frac{\text{kgCaCO}_3}{\text{d}} \\ &= 223 \text{ kgCa(OH)}_2 \text{ per day} \end{aligned}$$

35.4 PRINCIPLES OF BIOLOGICAL DENITRIFICATION**35.4.1 Preliminaries**

As seen in other chapters in this book, under aerobic conditions the microorganisms use the oxygen as “electron acceptors” in the respiration processes. In these conditions, there is a process of oxidation of the organic matter, in which the

following reactions take place (simplified analysis):



Therefore, the oxygen is the electron acceptor in the processes of aerobic respiration. However, in the absence of oxygen, there is a predominance of organisms that have the capacity to use other inorganic anions as electron acceptors, such as the nitrates, sulfates and carbonates. The first to be used will be that which is available in the medium and whose reaction releases the largest amount of energy. In sewage treatment, both of these requirements can be satisfied by the nitrates, which are generated by the nitrification process. Thus, in conditions of total depletion of dissolved oxygen, the microorganisms start to use the nitrates in their respiration. Such conditions are not properly anaerobic, but are named *anoxic*. A simple distinction among the three conditions is:

- *aerobic conditions*: presence of oxygen
- *anoxic conditions*: absence of oxygen, presence of nitrate
- *anaerobic conditions*: absence of oxygen and nitrates, presence of sulphates or carbonates

Denitrification corresponds to the reduction of nitrates to gaseous nitrogen. The main route for biological denitrification starts with the nitrates, and this is the reason why in sewage treatment denitrification should be preceded by nitrification. The microorganisms involved in denitrification are *facultative heterotrophic* and are usually abundant in domestic sewage; examples are *Pseudomonas*, *Micrococcus* and others (Arceivala, 1981).

For denitrification to occur, the heterotrophic microorganisms require a source of organic carbon (electron donor), such as methanol, that can be added artificially or be available internally in the domestic sewage. For the organic carbon in the sewage, the denitrification reaction is (Arceivala, 1981):

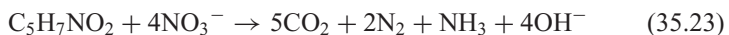

In the reaction above, $\text{C}_5\text{H}_7\text{NO}_2$ corresponds to the typical composition of the bacterial cell. Including assimilation, the consumption is approximately $3 \text{ mgC}_5\text{H}_7\text{NO}_2/\text{mgNO}_3^- \text{-N}$, or approximately $4.5 \text{ mgBOD}_5/\text{mgNO}_3^- \text{-N}$. As most of the domestic sewage has a $\text{BOD}_5:\text{N}$ ratio that is larger than that mentioned, the use of internally available carbon becomes an attractive and economic method of achieving denitrification (Arceivala, 1981). However, it should be remembered that, depending on the location in the treatment line, most of the BOD will have already been removed, thus reducing the availability of organic carbon for denitrification.

35.4.2 Reasons for and advantages of intentionally induced denitrification in the treatment system

In activated sludge systems where nitrification occurs, it is interesting to include a denitrification stage to be intentionally accomplished in the reactor. This intentional denitrification is made possible through the incorporation of anoxic zones in the reactor, as detailed in Chapter 36. The reasons are usually associated with some of the following aspects:

- economy of oxygen (savings on energy)
- reduced alkalinity requirements (preservation of the buffer capacity of the mixed liquor)
- operation of the secondary sedimentation tank (to avoid rising sludge)
- control of nutrients (eutrophication)

(a) Economy of oxygen

A great advantage of intentional denitrification taking place in the activated sludge system is that the oxygen released by nitrate reduction can become immediately available for the biological oxidation of the organic matter in the mixed liquor. The release of oxygen through the reduction of nitrates occurs according to the denitrification reaction (Equation 35.4, described in Section 35.2):

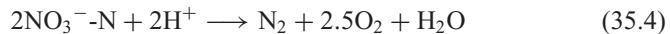

Thus, each 2 moles of nitrate release 2.5 moles of oxygen, that is:

the reduction of 1 mg/L of nitrogen in the form of nitrate releases 2.86 mgO₂/L

As seen in Section 35.3.5, the oxidation of 1 mg of nitrogen in the form of ammonia implies the consumption of 4.57 gO₂. As a result, if total denitrification is achieved, a **theoretical saving of 62.5%** can be obtained (2.5/4.0 or 2.86/4.57) in the consumption of the oxygen used in the nitrification.

In the design of the treatment plants this economy can be taken into consideration, if a reduction in the required power for the aerators is desired. In the operation of the plant, the denitrification will make it possible to reduce the consumption of energy, provided that the aeration level is controlled to maintain the desired DO concentration in the reactor.

(b) Economy of alkalinity

As seen in Section 35.3.2, the maintenance of a satisfactory level of alkalinity in the mixed liquor is of great importance to keep the pH within the adequate range for nitrification. From the denitrification reaction (Equation 35.4), it can be seen that the reduction of 1 mol of nitrate occurs along with the consumption of 1 mol of H⁺. During nitrification, the formation of 1 mol of nitrate implies the production of 2 moles of H⁺ (see Equation 35.3).

Thus, if denitrification is incorporated into the treatment system, a theoretical reduction of 50% in the release of H^+ can be obtained, that is to say, an **economy of 50% in alkalinity consumption**. Thus, if 7.1 mg/L of alkalinity are consumed for the nitrification of 1 g NH_4^+-N/L (see Section 35.3.6), only 3.5 mg/L of alkalinity will be consumed if denitrification is included in the system. Some authors (Barnes and Bliss, 1983; Eckenfelder Jr and Argaman, 1978) indicate a lower practical economy, in the order of 3 mg/L of alkalinity (alkalinity consumption of approximately 4.1 mg/L for nitrification combined with denitrification). Example 35.6 can be analysed from this new perspective and, in this case, the available alkalinity in the raw sewage will be sufficient.

(c) Operation of the secondary sedimentation tank

In secondary sedimentation tanks, the sludge has a certain detention time. For nitrified mixed liquors, under certain conditions, such as high temperatures, the situation becomes favourable for the occurrence of denitrification in the sedimentation tank. As a result, the nitrates formed in the reactor are reduced to gaseous nitrogen in the secondary sedimentation tank (see Equation 35.4). This implies the production of small bubbles of N_2 that adhere to the sludge, thus preventing it from settling, and carrying it to the surface. This is the so-called **rising sludge**. This sludge will leave with the final effluent, deteriorating its quality in terms of SS and BOD. This effect is particularly common in warm-climate regions, where high temperatures favour nitrification and denitrification.

Therefore, it is an appropriate strategy to prevent denitrification from taking place in the secondary sedimentation tank, while allowing it to occur in controlled locations, where the additional advantages of oxygen and alkalinity economy can be achieved.

(d) Nutrient control

Usually, when dealing with denitrification, the first point to come to mind is the control of eutrophication of water bodies through the removal of nutrients in wastewater treatment (see Chapter 3). This aspect, even though of great importance in some situations, is not always the decisive factor, for two reasons. The first is that not all the effluents from wastewater treatment plants go to sensitive water bodies, such as lakes, reservoirs or estuaries. For disposal to rivers, the control of nutrients is usually not necessary. The second reason, also very important, is that cyanobacteria, which are usually associated with the more developed stages of eutrophication, in which they proliferate in great numbers, have the capacity to absorb the atmospheric nitrogen and convert it into a form that can be assimilated. Thus, the nitrogen in the liquid medium is not the limiting factor for these organisms and the reduction in the amount conveyed by the wastewater will have a lower influence. In these conditions, the truly limiting nutrient is phosphorus. In Chapter 3, the conditions in which nitrogen or phosphorus are the limiting factors for eutrophication are discussed.

If phosphorus is really the limiting factor for algal growth, all the efforts in the wastewater treatment should be concentrated on its removal. However, the potential advantage of nitrogen removal should not be disregarded for the control of the trophic status of water bodies that still have a certain species diversity, with different requirements in terms of N and P.

35.4.3 Kinetics of denitrification

The denitrification rate can be obtained from the growth rate of the denitrifying microorganisms, similar to the calculations of the nitrification rate (Section 35.3.1). The growth rate can be expressed in terms of Monod's kinetics, according to the electron acceptor (nitrate) and donor (organic matter) concentration, as follows:

$$\mu = \mu_{\max} \cdot \left[\frac{S}{K_S + S} \right] \cdot \left[\frac{NO_3^-}{K_{NO_3^-} + NO_3^-} \right] \quad (35.24)$$

where:

S = concentration of carbonaceous matter (mgBOD/L)

K_S = half-saturation coefficient for the carbonaceous matter (mgBOD/L)

NO_3^- = concentration of nitrogen in the form of nitrate (mgN/L)

K_{NO_3} = half-saturation coefficient for the nitrogen in the form of nitrate (mgN/L)

Usually $NO_3^- \gg K_{NO_3}$ (EPA, 1993), which makes the term in the second bracket in Equation 35.24 negligible, that is, it can be considered that the growth rate of the denitrifying bacteria does not depend on the nitrate concentration in the medium (zero-order reaction with relation to the nitrate).

However, the value of K_S for the carbonaceous matter depends fundamentally on the type of organic carbon, which is a function of the denitrification system adopted and the characteristics of the process, such as the sludge age. Depending on the value of K_S , the growth rate can be of order 0 or 1 for the organic carbon. With this range of variations, and aiming at keeping a simple model structure, it is not very practical to design the activated sludge system by expressing the denitrification rate in terms of the growth rate of the denitrifying organisms, according to Monod's kinetics.

A simplified way to express the denitrification rate is through the relation with the volatile suspended solids in the reactor (denitrification rate = $\mu_{\text{denit}}/Y_{\text{denit}}$). Typical values of the denitrification rate are given in Table 35.3.

The denitrification rate in the anoxic zone upstream of the reactor is higher than in the anoxic zone downstream of the reactor. This is because in the first anoxic zone the raw sewage contains high levels of organic carbon, which are necessary for the denitrifying bacteria. On the other hand, in the second anoxic zone most of the organic carbon has been already removed in the reactor, leading to a predominance of the endogenous metabolism, with low denitrification rates.

Table 35.3. Typical ranges of the specific denitrification rate

Position of the anoxic zone	Source of organic carbon	Specific denitrification rate (mgNO ₃ ⁻ -N /mgVSS·d)
Anoxic zone upstream of the aerated zone	Raw sewage	0.03–0.11
Anoxic zone downstream of the aerated zone	Endogenous metabolism	0.015–0.045

Source: Eckenfelder and Argaman (1978); Arceivala (1981); Metcalf and Eddy (1991); EPA (1993)

The denitrification rate decreases with the increase in the sludge age (or the reduction in the F/M ratio). In Table 35.3, within each range, the smallest values correspond to the highest sludge ages. EPA (1993) includes two equations that correlate the denitrification rate with F/M and θ_c :

- Anoxic zone upstream of the aerated zone:

$$\text{SDR} = 0.03 \times (\text{F}/\text{M}_{\text{anox}}) + 0.029 \quad (35.25)$$

- Anoxic zone downstream of the aerated zone

$$\text{SDR} = 0.12 \times \theta_c^{-0.706} \quad (35.26)$$

where:

SDR = specific denitrification rate (mgNO₃⁻-N/mgVSS·d)

F/M_{anox} = food/microorganism ratio in the first anoxic zone (not in the reactor as a whole) (kgBOD/kgMLSS in the first anoxic zone per day)

θ_c = sludge age (d)

The processes for achieving denitrification in the activated sludge system are discussed in Chapter 36, where an analysis is made of different flowsheets, the position of the anoxic and aerated zones, the recirculations and the differences between the use of raw sewage and the carbon from the endogenous respiration. Relevant examples are provided in this chapter.

35.4.4 Environmental factors of influence on denitrification

Compared with the nitrifying bacteria, the denitrifying bacteria are much less sensitive to environmental conditions. However, the following environmental factors influence the denitrification rate:

- dissolved oxygen
- temperature
- pH
- toxic or inhibiting substances

(a) Dissolved oxygen

The absence of oxygen is obviously a fundamental pre-requisite for the occurrence of denitrification. Anoxic conditions are needed in the floc, that is, in the immediate vicinity of the denitrifying bacteria. Hence, it is possible that there is dissolved oxygen at low concentrations in the liquid medium and, even so, denitrification takes place, because of the fact that the denitrifying bacteria are in an anoxic micro-environment within the floc.

Metcalf and Eddy (1991) present the following equations for correcting the denitrification rate for the presence of DO. It should be noted that the rate decreases linearly with the increase of DO and reaches zero when DO is equal to 1.0 mg/L.

$$\text{SDR}_{\text{DO}} = \text{SDR}_{20^\circ\text{C}} \times (1.0 - \text{DO}) \quad (35.27)$$

where:

SDR = specific denitrification rate, as determined in Section 35.4.3
($\text{mgNO}_3^- \text{-N/mgVSS}\cdot\text{d}$)

$\text{SDR}_{20^\circ\text{C}}$ = specific denitrification rate with inhibition due to the presence of DO
($\text{mgNO}_3^- \text{-N/mgVSS}\cdot\text{d}$)

DO = dissolved oxygen (mg/L)

The specific growth rate of the denitrifying bacteria and, in other words, the denitrification rate, can also be modelled according to Monod's kinetics, with the inhibition term for DO included (IAWPRC, 1987; EPA, 1993). Equation 35.28 corresponds to Equation 35.24, with the DO inhibition term. Note that the term for DO, since it is related to inhibition, is given with inverted numerators and denominators compared to the nutrient terms (S and N).

$$\mu = \mu_{\text{max}} \cdot \left[\frac{S}{K_S + S} \right] \cdot \left[\frac{\text{NO}_3^-}{K_{\text{NO}_3^-} + \text{NO}_3^-} \right] \cdot \left[\frac{K_O}{K_O + \text{DO}} \right] \quad (35.28)$$

where:

K_O = half-saturation coefficient for oxygen (mg/L). A value of K_O equal to 1.0 is suggested by the IAWPRC (1987) model.

Naturally, in a properly designed and operated anoxic zone, the DO should be equal or very close to zero, since there is no aeration in this zone. Denitrification can still happen in the reactor in a predictable way, such as in the anoxic zones in an oxidation ditch. It can also occur in a manner that was not predicted in the design, such as in poorly aerated zones in the reactor (bottom and corners).

(b) Temperature

Temperature has an effect on the growth rate of denitrifying bacteria and, as a consequence, on the denitrification rate. The denitrification reaction takes place

in a wide temperature range, from 0 °C to 50 °C, reaching its optimal level in the range of 35 °C to 50 °C (Barnes and Bliss, 1983).

The influence of temperature can be expressed in the conventional Arrhenius form, that is:

$$\text{SDR}_T = \text{SDR}_{20^\circ\text{C}} \theta^{(T-20)} \quad (35.29)$$

where:

SDR = specific denitrification rate at a temperature T (mgNO₃⁻-N/mgVSS·d)

SDR_{20°C} = specific denitrification rate at the temperature of 20 °C (mgNO₃⁻-N/mgVSS·d)

T = temperature of the liquid (°C)

θ = temperature coefficient

Very broad ranges are given in the literature for the temperature coefficient θ. Arceivala (1981) mentions values between 1.15 and 1.20. EPA (1993) lists values ranging from 1.03 to 1.20, with the predominance of values close to 1.08. Metcalf and Eddy (1991) use the value of 1.09.

(c) pH

There is a certain variation in the literature regarding the ideal pH for denitrification. Arceivala (1981) indicates values in the range of 7.5 to 9.2, while Barnes and Bliss (1983) suggest a range from 6.5 to 7.5, with 70% decline in the denitrification rate for a pH of 6 or 8. EPA (1993) presents four curves for the variation of the denitrification rate with pH. The general tendency in these curves is that the maximum rate occurs at a pH between 7.0 and 7.5 and decreases approximately linearly with both the reduction and the increase in pH. For a pH of 6.0, the denitrification rates vary between 40% and 80% of the maximum value. For a pH of 8.0, the denitrification rates vary between approximately 70 and 90% of the maximum rate.

In spite of the variation of the information, it can be concluded that the pH should be close to neutrality and values below 6.0 and above 8.0 should be avoided.

(d) Toxic or inhibiting substances

The major route for the occurrence of denitrification is after nitrification. As already discussed, the nitrifying bacteria are much more sensitive to toxic or inhibiting substances than the heterotrophic bacteria responsible for denitrification. In addition, the denitrifying bacteria are present in a larger diversity of species, which reduces the impact of some specific inhibiting agent. Thus, if toxic or inhibiting substances are present, it is very likely that denitrification will be very reduced (or eliminated) for the simple reason that nitrification is inhibited.

35.5 PRINCIPLES OF BIOLOGICAL PHOSPHORUS REMOVAL

35.5.1 Mechanisms of biological phosphorus removal

For biological phosphorus removal, it is *essential to have anaerobic and aerobic zones* in the treatment line. The most convenient arrangements of both zones are discussed in Chapter 36.

The early explanations for the mechanism of biological phosphorus removal referred to the anaerobic zone as causing a condition of bacterial stress that would result in phosphorus being released in this zone. After that, high assimilation of the phosphorus available in the liquid medium would occur in the aerobic zone at a higher level than the normal metabolic requirements of the bacteria. When removing the excess biological sludge, bacteria with high phosphorus levels are also removed.

As more information has become available through intense research in this area in the past years, a mechanistic model has been developed, which includes fundamental biochemical aspects. It should be noted that, in spite of the great progresses made in this area, some knowledge gaps still need to be filled in. Several of the organisms involved are taxonomically unknown. The current mathematical models for biological phosphorus removal, such as the IWA models (IAWQ, 1995, and subsequent versions), are extremely complex and are still being tested in full-scale activated sludge plants. However, the merit exists as the increasing knowledge in the area has allowed better designs and operational control strategies to be developed.

This book deals with biological phosphorus removal in a simplified way. More recent and deeper information should be obtained from specific publications, since the theme has developed significantly.

Biological phosphorus removal is based on the following fundamental points (Sedlak, 1991, IAWQ, 1995):

- Certain bacteria are capable of accumulating excess amounts of phosphorus in the form of polyphosphates. These microorganisms are named phosphorus accumulating organisms (PAOs). The bacteria most frequently mentioned as an important PAO is *Acinetobacter*.
- These bacteria are capable of removing simple fermentation substrates produced in the anaerobic zone and then assimilate them as products stored inside their cells.
- In the aerobic zone, energy is produced by the oxidation of these stored products. The storage of polyphosphates in the cell increases.

The anaerobic zone is considered a *biological selector* for the phosphorus accumulating microorganisms. This zone has an advantage in competition terms for the phosphorus accumulating organisms, since they can assimilate the substrate in this zone before other microorganisms, which are not phosphorus accumulating organisms. Thus, this anaerobic zone allows the development or selection of a large

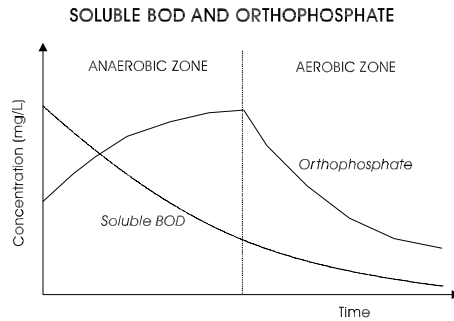

Figure 35.2. Variation of the soluble BOD and orthophosphate concentrations in the anaerobic and aerobic zones in an activated sludge system designed for biological phosphorus removal (adapted from EPA, 1987)

population of phosphorus accumulating organisms (PAOs) in the system, which absorb substantial amounts of phosphorus in the liquid medium. Phosphorus is then removed from the system with the excess sludge (Sedlak, 1991).

Figure 35.2 presents typical profiles of soluble BOD and orthophosphates in anaerobic and aerobic zones in an activated sludge system designed for phosphorus removal. The concentration of soluble BOD decreases in the anaerobic zone, even if there are no aerobic or anoxic electron acceptors. In the anaerobic zone, while the soluble BOD concentration decreases, the soluble phosphorus concentration increases. Subsequently, in the aerobic zone, the phosphorus concentration decreases, while the soluble BOD concentration continues in its decline.

The biological phosphorus removal mechanism is summarised in Figure 35.3 and is described in the following paragraphs (EPA, 1987b; Sedlak, 1991; Henze, 1996).

Alternation between anaerobic and aerobic conditions

- *Alternation of conditions.* The PAO require the alternation between anaerobic and aerobic conditions, to build their internal energy, organic molecules and polyphosphate storage components.

Anaerobic conditions

- *Production of volatile fatty acids by facultative bacteria.* Part of the biodegradable organic matter (soluble BOD) is converted, through fermentation processes in the raw sewage or in the anaerobic zone, into simple organic molecules of low molecular weight, such as volatile fatty acids. This conversion is usually made by facultative organisms that normally occur in the sewage and in the anaerobic zone. The volatile fatty acids become available in the liquid medium. There is not enough time for hydrolysis and the conversion of the particulate influent organic matter.
- *Accumulation of the volatile fatty acids by the PAOs.* The phosphate accumulating organisms give preference to these volatile fatty acids, which are

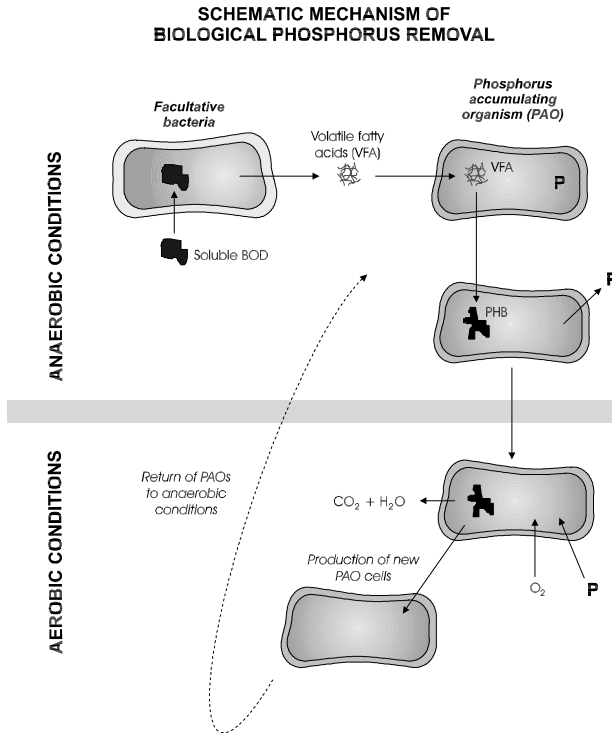

Figure 35.3. Schematic mechanism of biological phosphorus removal

quickly assimilated and accumulated inside the cells. PAOs assimilate these fermentation products better than the other organisms usually occurring in the activated sludge process. As a consequence, there is a selection of the population of these phosphorus accumulating organisms in the anaerobic zone.

- *Phosphate release.* The release of phosphate that was previously accumulated by the organisms (in the aerobic stage) supplies energy for the transport of the substrate and for the formation and storage of organic metabolic products, such as PHB (polyhydroxybutyrate).

Aerobic conditions

- *Consumption of the stored substrate and assimilation of phosphate.* PHB is oxidised into carbon dioxide and water. The soluble phosphate is removed from the solution by the PAOs and is stored in their cells for generation of energy in the anaerobic phase.
- *Production of new cells.* Due to the use of substrate, the PAO population increases.

Phosphorus removal

- *Phosphorus removal by the excess sludge.* The phosphorus is incorporated in large amounts into the PAOs cells and is removed from the system through the removal of the biological excess sludge, which discards a fraction of the mixed liquor containing all the organisms in the activated sludge, including PAOs.

35.5.2 Factors of influence on biological phosphorus removal

The following factors influence the performance of biological phosphorus removal (EPA, 1987b; Sedlak, 1991):

- *environmental factors*
 - DO
 - temperature
 - pH
 - nitrate in the anaerobic zone
- *design parameters*
 - sludge age
 - detention time and configuration of the anaerobic zone
 - detention time in the aerobic zone
 - excess sludge treatment methods
- *characteristics of the influent sewage*
- *suspended solids in the effluent*

(a) Dissolved oxygen

Biological phosphorus removal depends on the alternation between anaerobic and aerobic conditions. Naturally, there will be no dissolved oxygen available in the anaerobic zone. The presence of DO in anaerobic zones has been reported to decrease phosphorus removal and cause the growth of filamentous bacteria. DO can come from the raw sewage through infiltration, screw pumps, turbulence and cascading in the inlet structures, aeration in grit chambers and vortices created by stirrers in the anaerobic zone.

For the aerobic zone, there are no generally accepted studies that describe the effects of the DO concentration on the phosphorus removal efficiency. The mechanism of biological phosphorus removal suggests that the DO concentration can affect the phosphorus removal rate in the aerobic zone, but not the possible degree of removal, provided there is enough aerobic time.

However, there is evidence that in treatment plants the DO concentration in the aerobic zone should be kept between 1.5 and 3.0 mg/L. If the DO is very low, the phosphorus removal can reduce and the nitrification will be limited, possibly leading to the development of sludge with poor settleability. If the DO is very high, the denitrification efficiency can be reduced due to DO entering the first anoxic zone. As a consequence, an increased concentration of nitrates can occur, which affects the release of phosphorus in the anaerobic zone.

The control of DO in the aerobic zone is very important and usually plants with biological phosphorus removal are provided with automated control of the aeration capacity and the DO concentration.

(b) Temperature

Biological phosphorus removal has been successfully applied in a wide range of temperatures, and it seems that the phosphorus removal capacity is not affected by low temperatures. However, there are indications that the phosphorus release rate is lower for low temperatures, and longer detention times are needed in the anaerobic zone for fermentation to be completed and/or the substrate consumed.

(c) pH

Studies on the influence of pH on phosphorus removal suggest the following points:

- phosphorus removal is more efficient at a pH between 7.5 and 8.0
- phosphorus removal is reduced significantly at pH values lower than 6.5, and all activity is lost at a pH close to 5.0

(d) Nitrate in the anaerobic zone

The entrance of nitrate into the anaerobic zone reduces the phosphorus removal efficiency. This is because the nitrate reduction in the anaerobic zone uses substrate that, otherwise, would be available for assimilation by phosphorus accumulating organisms. As a consequence, the nitrate has the effect of reducing the BOD/P ratio in the system. The influence depends on the influent BOD and the phosphorus concentration, as well as on the sludge age. Item (i) below includes other considerations about this topic.

The various processes available for biological phosphorus removal have different internal recirculation methods and, therefore, the potential for nitrates to return or not to the anaerobic zone will differ among them. Care should also be taken in respect to the return of nitrates through the return sludge from the secondary sedimentation tanks.

(e) Sludge age

Systems operating with higher sludge ages produce less excess sludge. The main phosphorus removal route in the system is through the excess sludge, since phosphorus is accumulated in high concentrations in the bacterial cells. Thus, the larger the sludge age, the lower the sludge production, the lesser the wastage of excess sludge, and the smaller the phosphorus removal from the system. Therefore, extended aeration systems are less efficient in phosphorus removal than conventional activated sludge systems.

Systems with a high sludge age require higher BOD/P ratios in the influent to reach concentrations of soluble phosphorus in the effluent below 1.0 mg/L.

To maximise phosphorus removal, the systems should not operate with sludge ages above those required for the overall treatment requirements.

(f) Detention time and configuration of the anaerobic zone

Detention times in the anaerobic zone have been traditionally established between 1 and 2 hours. This period of time is needed for fermentation to produce the volatile fatty acids consumed by the phosphorus accumulating organisms. After 2 hours, most of the applied BOD is already removed from the solution.

Extended periods of time should be avoided in the anaerobic zone, because they can cause the release of phosphorus without the consumption of volatile fatty acids. When this happens, there are not enough carbon storage products inside the cells to produce the necessary energy for the total absorption of the phosphorus released.

The configuration of the anaerobic zone also affects phosphorus removal. The division of the anaerobic zone into two or more compartments in series improves phosphorus removal. Naturally, the costs of the dividing walls and increased mixing equipment requirements need to be considered.

(g) Detention time in the aerobic zone

The aerobic zone plays an important role, creating conditions for the absorption of phosphorus after its release in the anaerobic zone. As the aerobic stage is designed to allow enough time for BOD removal and nitrification, it is expected that there will be enough time for phosphorus absorption. This aspect becomes critical if the aerobic zone is not always entirely oxygenated. There are still no conclusive findings about the aerobic detention time required, but there are some indications that 1 to 2 hours are enough.

(h) Excess sludge treatment methods

Special care should be taken in the sludge treatment stage to avoid anaerobic conditions that favour the release into the liquid of the phosphorus stored in the biomass. In this respect, the following points should be noted:

- adoption of thickening by dissolved air flotation is preferable to gravity thickening
- aerobic digestion is preferable to anaerobic digestion
- dewatering of the sludge by fast and continuous processes is preferable to the dewatering by equipment with intermittent operation or with time-consuming methods

(i) Characteristics of the influent sewage

For biological phosphorus removal, organic fermentation products need to be available for the phosphorus accumulating organisms. The more they are available in the anaerobic zones, the larger the phosphorus removal. It is important that the organic matter is available in the soluble form (soluble BOD) to make fermentation possible, since the short hydraulic detention times in the anaerobic zone hinder the

assimilation of the slowly-biodegradable organic matter, such as the particulate BOD.

Sedlak (1991) mentions an advisable minimum ratio of soluble BOD: P in the influent of 15:1, to obtain low concentrations of soluble phosphorus in the effluent from systems with relatively low sludge ages.

The Water Research Commission (1984) makes the following comments. The mentioned treatment processes are described in Chapter 36:

- If the rapidly biodegradable COD concentration (approximately equivalent to the soluble COD) in the influent is less than 60 mg/L, irrespective of the total COD concentration, it is not very likely that a significant phosphorus removal will be achieved with any process.
- If the rapidly biodegradable COD concentration is higher than 60 mg/L, phosphorus removal can be achieved, provided that the nitrate is excluded from the anaerobic zone. The removal of P increases quickly with the increase in the biodegradable COD concentration.
- The ability to prevent nitrates from going into the anaerobic zone will depend on the TKN/COD ratio in the influent and the process adopted for phosphorus removal. Some limits are indicated below for typical domestic sewage (from South Africa):
 - **COD/TKN > 13** mgCOD/mgN. Complete removal of nitrate is possible. The Phoredox process is recommended.
 - **COD/TKN: 9 to 13** mgCOD/mgN. Complete removal of nitrates is no longer possible, but the nitrates can be excluded from the anaerobic zone by using the modified UCT process.
 - **COD/TKN: 7 to 9** mgCOD/mgN. The modified UCT process cannot exclude the nitrate from the anaerobic compartment. The UCT process is recommended, provided that the internal recirculation from the aerobic to the anoxic zone is carefully controlled.
 - **COD/TKN < 7** mgCOD/mgN. Biological phosphorus removal in systems with nitrification is unlikely to occur.

If BOD is adopted instead of COD, and a COD/BOD₅ ratio in the influent of around 2 is assumed, the values of the above relations are approximately half of those stated (e.g., a COD/TKN ratio of 10 corresponds to approximately BOD₅/TKN = 5).

Primary settling is unfavourable when trying to reach high efficiencies in N and P removal, because it increases the TKN/COD and P/COD ratios substantially, by reducing the COD concentration in the influent to the biological stage (although the concentration of soluble COD is little affected) (WRC, 1984).

(j) Suspended solids in the effluent

Since biological phosphorus removal is based on the incorporation of phosphorus in excessive amounts into the bacterial biomass, the loss of suspended solids in the effluent results in the increase of the phosphorus concentrations in this effluent. The phosphorus levels in the MLSS of biological P-removal processes range between

2 and 7% (and, under very favourable conditions, even more). Thus, if the effluent has a SS concentration equal to 20 mg/L and a proportion of P equal to 4%, this would imply that the P concentration discharged with the effluent SS is $20 \times 0.04 = 0.8$ mg/L. This value is high when considering that total P concentration usually desired for the final effluent in systems with BNR is around 1.0 mg/L. In these conditions, the soluble P concentration in the effluent should be no more than 0.2 mg/L ($= 1.0 - 0.8$), which is a very reduced value.

Thus, in situations where very low levels of P in the effluent are desired, it is very common to adopt polishing stages for the removal of suspended solids, such as filtration or flotation.

35.5.3 Modelling of biological phosphorus removal

The mechanistic models available for biological phosphorus removal have been developed substantially in the last years, as a result of intensive investigations in several parts of Europe, North America and South Africa. However, their degree of complexity is very high in view of the great number of variables and parameters involved, some of which are not directly measurable. The IWA models are an example of widely accepted models for the activated sludge process, including BNR. However, their degree of complexity is outside the scope of this book.

For this reason, the following simplified approach is presented for the estimation of the effluent phosphorus concentration, based mainly on the research by Professor Marais and co-workers, in South Africa (WRC, 1984).

(a) Determination of the fraction of P in the suspended solids

The main phosphorus removal route from the system is through its incorporation, in excessive amounts, into the biological excess sludge. With the removal of the excess sludge from the system, phosphorus removal is also achieved. Therefore, it is important to quantify the phosphorus fraction in the excess sludge solids (mgP/mgSS). Usually, this fraction is from 2% to 7% in systems with biological phosphorus removal. However, this value can be estimated using the methodology described below.

The *propensity factor of excess phosphorus removal* (P_f) is a parameter that reflects the system's ability to remove phosphorus. The value of P_f can be estimated using the following equation (WRC, 1984):

$$P_f = (f_{rb} \times \text{COD} - 25) \cdot f_{an} \quad (35.30)$$

where:

- f_{rb} = fraction of rapidly biodegradable COD in the influent
- COD = total COD of the influent wastewater (mg/L)
- f_{an} = mass fraction of the anaerobic sludge

The rapidly biodegradable fraction f_{rb} usually represents 15 to 30% of the total COD of the raw sewage, and 20 to 35% of the total COD of the sewage after primary settling (Orhon and Artan, 1994).

Influent BOD is converted into COD by simply multiplying it by a factor (COD/BOD₅ ratio) between 1.7 and 2.4.

With respect to the anaerobic sludge fraction f_{an} , if the concentration of solids is the same in all zones of the reactor, f_{an} can be considered equal to the ratio between the volume of the anaerobic zone and the total volume of the reactor (V_{anaer}/V_{tot}). Values of this anaerobic fraction vary between 0.10 and 0.25 (V_{anaer} varies between 10% and 25% of the total volume of the reactor).

The *phosphorus fraction in the active biomass* (mgP/mgX_a) can be expressed using the following relation (WRC, 1984):

$$P/X_a = 0.35 - 0.29 \cdot e^{-0.242 \cdot P_f} \quad (35.31)$$

As seen in Section 9.5.8, the active fraction of the mixed liquor volatile suspended solids (X_a/X_v) is given by:

$$f_a = \frac{1}{1 + 0.2 \cdot K_d \cdot \theta_c} \quad (35.32)$$

where:

K_d = coefficient of endogenous respiration (0.08 to 0.09 d⁻¹)

θ_c = total sludge age (d)

The ratio between the volatile suspended solids and the total suspended solids in the reactor (X_v/X) can be calculated, as shown in the example in Chapter 34, or be obtained from Table 31.8. Typical values are: (a) conventional activated sludge: 0.70 to 0.85, (b) extended aeration: 0.60 to 0.75. A quick way of calculating the ratio for the treatment of domestic sewage is to use the regression equations with the sludge age contained in Table 31.9, namely:

- system with primary sedimentation:

$$X_v/X = 0.817 \cdot \theta_c^{-0.043} \quad (35.33)$$

- system without primary sedimentation:

$$X_v/X = 0.774 \cdot \theta_c^{-0.038} \quad (35.34)$$

Thus, the phosphorus fraction in the suspended solids can be calculated through the following equations, whose terms can be obtained from Equations 35.31 to 35.34:

- Fraction of P in the *volatile* suspended solids in the excess sludge (mgP/mgVSS):

$$P/X_v = f_a \cdot (P/X_a) \quad (35.35)$$

- Fraction of P in the *total* suspended solids in the excess sludge (mgP/mgSS):

$$P/X = \left(\frac{VSS}{SS} \right) \cdot f_a \cdot (P/X_a) \quad (35.36)$$

Depending on the values of the influent COD and the rates and coefficients adopted, it is possible to obtain P/X values much higher than the value of 7% mentioned by EPA (1987b) and Orhon and Artan (1994). For safety reasons, it is suggested that, for design purposes, a maximum value of 7% is assigned for this relation.

(b) Removal of P with the excess sludge

The ratio of the phosphorus removed per unit of BOD removed (mgP/mgBOD) can be expressed as follows (EPA, 1987b):

$$P/BOD = Y_{obs} \cdot (P/X_v) \quad (35.37)$$

or

$$P/BOD = \frac{Y}{1 + f_b \cdot K_d \cdot \theta_c} \cdot (P/X_v) \quad (35.38)$$

where:

P/X_v = fraction of P in VSS (calculated from Equation 35.35) (mgP/mgVSS)

Y = yield coefficient (0.4 to 0.8 mgVSS/mgBOD)

f_b = biodegradable fraction of the VSS (mgSS_b/mgVSS)

The f_b value can be calculated from Equation 9.68 (Section 9.5.8), as follows:

$$f_b = \frac{0.8}{1 + 0.2 \cdot K_d \cdot \theta_c} \quad (35.39)$$

Typical values of f_b are: (a) conventional activated sludge: 0.55 to 0.70 and (b) extended aeration: 0.40 to 0.65.

The amount of phosphorus removed in the excess sludge, taking into consideration the amount of BOD removed, can be determined by multiplying the result of Equation 35.38 by the removed BOD concentration ($S_o - S$):

$$P_{rem} = \frac{Y}{1 + f_b \cdot K_d \cdot \theta_c} \cdot (P/X_v) \cdot (S_o - S) \quad (35.40)$$

where:

P_{rem} = concentration of P removed in the excess sludge (mg/L)

S_o = total influent BOD concentration to the biological stage (mg/L)

S = soluble effluent BOD concentration from the biological stage (mg/L)

(c) Effluent P concentration

The concentration of the effluent *soluble phosphorus* is given by the difference between the total effluent concentration of P and the removed concentration of P (given by Equation 35.40):

$$P_{\text{sol eff}} = P_{\text{tot inf}} - P_{\text{rem}} \quad (35.41)$$

The concentration of the effluent *particulate phosphorus* (present in the effluent SS) is determined by multiplying the SS concentration in the effluent from the system by the fraction of P in the suspended solids (P/X). P/X is given in Equation 35.36.

$$P_{\text{part eff}} = \text{SS} \cdot (P/X) \quad (35.42)$$

The total effluent phosphorus concentration is the sum of the concentrations of soluble P and particulate P in the effluent:

$$P_{\text{tot eff}} = P_{\text{sol eff}} + P_{\text{part eff}} \quad (35.43)$$

The example in Section 36.2 illustrates this calculation method for biological phosphorus removal.

36

Design of continuous-flow systems for biological nutrient removal

36.1 BIOLOGICAL NITROGEN REMOVAL

36.1.1 Processes most frequently used

The main flowsheets for nitrification and denitrification combined in a single reactor are as follows (see Figure 36.1):

- pre-denitrification (removal of nitrogen with carbon from the raw sewage)
- post-denitrification (removal of nitrogen with carbon from endogenous respiration)
- four-stage Bardenpho process
- oxidation ditch
- intermittent operation reactor (sequencing batch reactor)

There are still other processes, with nitrification and denitrification in separate lines from carbon removal, as well as other processes that use an external carbon source (usually methanol) for denitrification. However, these systems are more complex, which makes the single reactor systems without external carbon source more frequently used. Each of the main variants presented in Figure 36.1 are described below. There are still other interesting processes in which N removal follow other routes (e.g. Sharon-Anammox process), but these are outside the scope of this book.

BIOLOGICAL NITROGEN REMOVAL

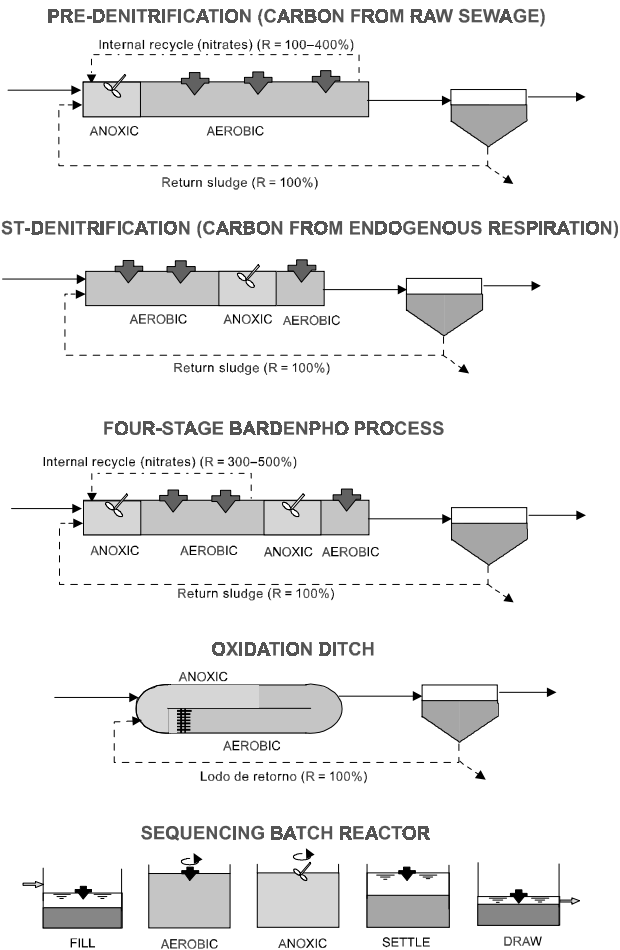

Figure 36.1. Main processes for biological nitrogen removal

(a) Pre-denitrification (removal of nitrogen with carbon from raw sewage)

The reactor has an anoxic zone followed by the aerobic zone. Nitrification occurs in the aerobic zone, leading to the formation of nitrates. The nitrates are directed to the anoxic zone by means of an internal recirculation. In the anoxic zone, the nitrates are converted into gaseous nitrogen, which escapes to the atmosphere. Should there be no internal recirculation, the only form of return of the nitrates would be through the return sludge, with the possible operational risks of denitrification in the secondary sedimentation tank (formation of N_2 bubbles, causing rising sludge). This process is also named modified Ludzack-Ettinger.

The internal recirculation is done with high recycle ratios, ranging from 100 to 400% of the influent flow. The efficiency of denitrification is highly associated with the quantity of nitrate that returns to the anoxic zone. For example, if 80% of the nitrates are returned to the anoxic zone, their potential removal is 80%. The other 20% leave with the final effluent. The formula that determines the amount of nitrate to be returned to the anoxic zone is:

$$F_{NO_3 \text{ rec}} = \frac{R_{\text{int}} + R_{\text{sludge}}}{R_{\text{int}} + R_{\text{sludge}} + 1} \tag{36.1}$$

where:

$F_{NO_3 \text{ rec}}$ = fraction of the nitrates formed that are recirculated to the anoxic zone (corresponds to the maximum theoretical NO_3^- removal efficiency)

R_{int} = internal recirculation ratio

R_{sludge} = sludge recirculation ratio (return sludge ratio)

For example, if the internal recirculation ratio were 0% ($R_{\text{int}} = 0$) and the sludge recirculation ratio were 100% ($R_{\text{sludge}} = 1.0$), only 50% ($F_{NO_3 \text{ rec}} = 0.5$) of the nitrates would return to the anoxic zone, and the remaining 50% would leave with the final effluent. With an internal recirculation ratio of 300% ($R_{\text{int}} = 3.0$) and a sludge recirculation ratio of 100% ($R_{\text{sludge}} = 1.0$), 80% of the formed nitrates would return to the anoxic zone ($F_{NO_3 \text{ rec}} = 0.8$), where they would have the chance to be converted into gaseous nitrogen. In this latter case, the maximum theoretical nitrate removal efficiency would be of 80%.

Figure 36.2 presents the maximum theoretical nitrate removal efficiency values ($F_{NO_3 \text{ rec}}$) as a function of the total recirculation ratio ($R_{\text{int}} + R_{\text{sludge}}$).

In the anoxic zones of pre-denitrification systems, the denitrification rate is high (0.03 to 0.11 $mgNO_3^- \cdot N/mgVSS \cdot d$), due to the high concentration of organic carbon in the anoxic zone, brought by the raw sewage. Primary sedimentation can be omitted to allow the input of a higher load of organic carbon in the anoxic zone.

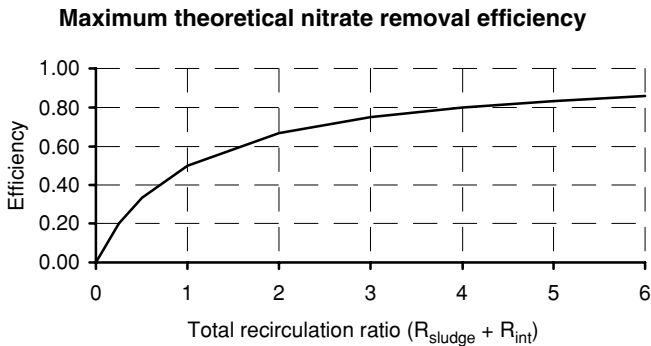

Figure 36.2. Maximum theoretical nitrate removal efficiency values in systems with pre-denitrification as a function of the total recirculation ratio ($R_{\text{int}} + R_{\text{sludge}}$)

The advantages of the pre-denitrification systems are:

- low detention time in the anoxic zone, compared to the post-denitrification systems
- reduction in the oxygen consumption in view of the stabilisation of the organic matter using nitrate as electron acceptor in the anoxic zone
- possibility of the reduction of the volume of the aerobic zone, as a result of the stabilisation of part of the BOD in the anoxic zone (the reduction in the volume should be such as not to affect nitrification)
- there is no need for a separate reaeration tank, like in the post-denitrification arrangement

The disadvantage is that, to reach high denitrification efficiencies, very high internal recirculation ratios are needed, which is not always economically advisable. For this reason, the internal recirculation ratios are limited to 400% or 500%. The internal recirculation pumping stations are designed to work under low heads (the water level in the anoxic and aerobic zones is practically the same) and high flows.

(b) Post-denitrification (removal of nitrogen with carbon from endogenous respiration)

The reactor comprises an aerobic zone followed by an anoxic zone and, optionally, a final aerobic zone. The removal of carbon and the production of nitrates occur in the aerobic zone. The nitrates formed enter the anoxic zone, where they are reduced to gaseous nitrogen. Thus, there is no need of internal recirculations, as in the pre-denitrification system. This process, without the final aerobic zone, is named Wuhrmann process.

The disadvantage is that denitrification is carried out under endogenous conditions, since most of the organic carbon to be used by the denitrifying bacteria has been removed in the aerobic zone. Therefore, the denitrification rate is slower (0.015 to 0.045 mgNO₃⁻-N/mgVSS·d), which implies longer detention times in the anoxic zone, compared with the pre-denitrification alternative.

A possibility to increase the denitrification rate is by the addition of an external carbon source, such as methanol. Although this practice leads to high denitrification rates, it is less frequently applied in developing countries, since it requires the continuous addition of a chemical product.

Another possibility to increase the denitrification rate in the anoxic zone is by directing part of the raw sewage straight to the anoxic zone, by-passing the aerobic zone. Even if a considerable fraction of BOD from the by-pass line could still be removed in the anoxic zone, the introduction of a non-nitrified nitrogen (ammonia) into the anoxic zone could be a problem, as it could deteriorate the effluent quality.

The final zone is for reaeration, with a short detention time (approximately 30 minutes). The main purposes are the release of gaseous nitrogen bubbles and the addition of dissolved oxygen prior to sedimentation.

(c) Four-stage Bardenpho process

The Bardenpho process corresponds to a combination of the two previous arrangements, comprising pre-denitrification and post-denitrification, besides the final reaeration zone. The nitrogen removal efficiency is high, of at least 90%, since the nitrates not removed in the first anoxic zone have a second opportunity to be removed, in the second anoxic zone. The disadvantage is that it requires reactors with a larger total volume. However, when high nitrogen removal efficiencies are required, this aspect should not be considered a disadvantage, but a requirement of the process.

(d) Oxidation ditch

The liquid circulates in the oxidation ditch, passing many times (70 to 100 times a day) through the zones with and without aeration. Aerobic conditions prevail in the aerated zones and a certain distance downstream them. However, as the liquid becomes more distant from the aerator, the oxygen concentration decreases, being liable to reach anoxic conditions at a certain distance. This anoxic zone is limited by the next aerator, where the aerobic conditions restart.

This alternation between aerobic and anoxic conditions allows the occurrence of BOD removal and nitrification in the reactor, besides denitrification itself. The nitrifying and denitrifying bacteria are not harmed by these alternating environmental conditions, so that where there is dissolved oxygen available, nitrates will be formed, and where it lacks, nitrates will be reduced.

The oxidation ditches may have more than one aerator, a condition in which there may be more than one aerobic zone and more than one anoxic zone. Naturally, for the occurrence of denitrification, there should be no overlapping of aerobic zones, leading to a suppression of the anoxic zones, in view of an excessive number of aerators in the reactor.

Conventional ditches (Pasveer ditches) have horizontal-shaft aerators (rotors), while the Carrousel-type ditches have vertical-shaft aerators.

The behaviour of the ditches regarding nitrogen removal takes place according to dynamics different from the other systems, due to the DO gradient and the fast alternation between aerobic and anoxic conditions. Figure 36.3 shows the close relation between DO concentration and nitrification in two ditches in England (von Sperling, 1993b). During the total sampling period, there were successive reductions and increases in the nitrification capacity. The increased DO concentration implies a reduced concentration of ammonia in the ditch, and the decreased DO causes an increase in the concentration of ammonia. The observation of the time series of ammonia and DO presented in Figure 36.3 indicates a fast recovery of the nitrification, after the increase in the DO. Within a certain range, increases in the DO concentration, even if small, imply an almost immediate decrease in the concentration of ammonia. The fast recovery of the nitrification cannot be explained by Monod's conventional kinetics (von Sperling, 1990). It is probable that the frequent alternation between high and low DO concentration zones along the course of the liquid in the ditch creates satisfactory conditions

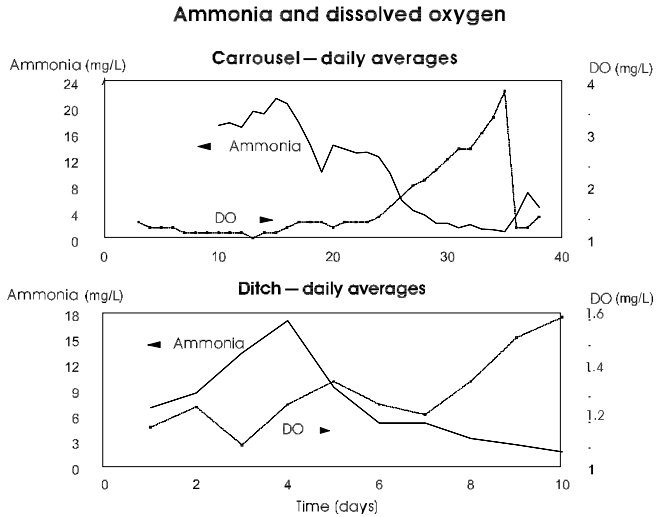

Figure 36.3. Relation between DO and nitrification in two oxidation ditches (von Sperling, 1993b)

for a fast increase in the growth rate of the nitrifying organisms, as soon as the average DO concentration in the tank (or the size of the higher DO concentration zones) increases. This same behaviour was noticed by the author in other ditches in England.

To obtain a higher denitrification efficiency in the ditches, there should be an automated control of the dissolved oxygen, altering the oxygen transfer rate by means of (a) turning on/off the aerators, (b) varying the aerator submergence (acting on the outlet weir level or on the vertical shaft of the aerators), or (c) varying the rotation speed of the aerators. This is due to the fact that, with a variable influent load over the day, the size of the aerobic zone would vary if the oxygen transfer rate were constant. As the aerators are usually designed for conditions of peak organic load, there could be a good balance between oxygen production and consumption in those moments, thus allowing the coexistence of aerobic and anoxic zones. However, in periods of lower load, such as during the night, the oxygen production would become larger than the consumption, making the anoxic zone decrease or contingently disappear, thus reducing substantially the overall nitrogen removal efficiency. For this reason, it is important that the aeration capacity is variable, allowing the oxygen production rate to follow the consumption rate, generating relatively stable DO concentrations and anoxic zone sizes. However, the selection of the DO set point is not simple: sufficient aerobic zones are needed for nitrification, but, at the same time, sufficient anoxic zones are needed for denitrification. In other words, enough oxygen should be provided for nitrification, but not excessively to inhibit the denitrification.

(e) Intermittent operation reactors (sequencing batch reactors)

The sequencing batch systems have a cyclic operation. Each cycle consists of a sequence of fill, reaction, settle, draw and, if necessary, idle stages. Depending on the load generation profile over the day, the system may have just one tank or more than one (two, three or more) in parallel, each one in a different stage of the cycle. Further details on sequencing batch reactors are presented in Chapter 37.

During the fill period, some nitrates remaining from the previous cycle may be removed, if the aerators are turned off. Therefore, pre-denitrification with organic carbon from the raw sewage occurs. An anoxic stage follows the aerobic reaction stage, in which post-denitrification occurs under endogenous conditions.

The advantage of the system is its conceptual simplicity, which does not require separate recirculations and sedimentation tanks.

36.1.2 Comparison between the performances of the biological nitrogen removal systems

Table 36.1 presents a comparison between the capacities of the systems described to meet different discharge objectives. If the aerobic sludge age is greater than approximately 5 days (or even greater, if the temperature, the DO, and the pH in the reactor are low), all the processes are capable to nitrify and meet an effluent ammonia level of 5 mg/L. In terms of total nitrogen, all the variants presented can meet targets ranging from 8 to 12 mg/L, but only the four-stage Bardenpho system can produce an effluent between 3 and 6 mg/L, or even less.

36.1.3 Design criteria for biological nitrogen removal

The main criteria, coefficients and rates for the design of systems with pre-denitrification, post-denitrification and four-stage Bardenpho are presented in Tables 36.2 and 36.3. The values of Table 36.3 refer to the N removal mathematical

Table 36.1. Capacity of several processes to meet different discharge targets for ammonia and total nitrogen

Process	Ammonia <5 mg/L ^a	Total nitrogen		
		8–12 mg/L	6–8 mg/L	3–6 mg/L
Reactor fully aerobic	X	–	–	–
Reactor with pre-denitrification	X	X	X ^b	–
Reactor with post-denitrification	X	X	–	–
Four-stage Bardenpho	X	X	X	X
Oxidation ditch	X	X	X ^c	–
Sequencing batch reactor	X	X	–	–

^a nitrification will occur consistently provided that aerobic θ_c is higher than approximately 5 d

^b with high internal recirculation ratios (R_{int} between 200 and 400%)

^c with efficient automatic control of dissolved oxygen

Source: Table prepared based on information from EPA (1993)

Table 36.2. Design criteria for biological nitrogen removal

Parameter	System with pre-denitrification	System with post-denitrification	Four-stage Bardenpho
MLVSS (mg/L)	1500–3500	1500–3500	1500–4000
Total θ_c (d)	6–10	6–10	10–30
Aerobic θ_c (d)	≥ 5	≥ 5	≥ 8
HDT – 1 st anoxic zone (hour)	0.5–2.5	–	1.0–3.0
HDT – aerobic zone (hour)	4.0–10.0	5.0–10.0	5.0–10.0
HDT – 2 nd anoxic zone (hour)	–	2.0–5.0	2.0–5.0
HDT – final aerobic zone (hour)	–	–	0.5–1.0
BOD removal ratio – anoxic zone/ aerobic zone	0.7	0.7	0.7
Sludge recirculation ratio R_{sludge} (Q_r/Q) (%)	60–100	100	100
Internal recirculation ratio R_{int} (Q_{int}/Q) (%)	100–400	–	300–500
Power level in the anoxic zone (W/m^3)	5–10	5–10	5–10
Average DO in the aerobic zone	2.0	2.0	2.0

Source: Adapted from IAWPRC (1987), Metcalf and Eddy (1991), Randall *et al.* (1992), EPA (1987, 1993)

Table 36.3. Typical values of the rates and kinetic and stoichiometric coefficients for the modelling of nitrification and denitrification

Stage	Coefficient or rate	Unit	Typical values or range
<i>Nitrification</i>	Spec. nitrifiers growth rate μ_{max} (20 °C)	d^{-1}	0.3–0.7
	Half-saturation coefficient K_N (ammonia)	$mgNH_4^+/L$	0.5–1.0
	Half-saturation coefficient K_O (oxygen)	mgO_2/L	0.4–1.0
	Temperature coefficient θ for μ_{max}	–	1.10
	Yield coefficient for nitrifiers Y_N	$mg\ cells/mgNH_4^+$ oxidation	0.05–0.10
	O_2 consumption	$mg\ O_2/mgNH_4^+$ oxidation	4.57
	Alkalinity consumption	$mg\ CaCO_3/mgNH_4^+$ oxidation	7.1
<i>Denitrification</i>	Denitrification rate SDR – 1 st anoxic zone	$mgNO_3^-/mgVSS \cdot d$	0.03–0.11
	Denitrification rate SDR – 2 nd anoxic zone	$mgNO_3^-/mgVSS \cdot d$	0.015–0.045
	Fraction of ammonia in the excess sludge	$mgNH_4^+/mg\ VSS$	0.12
	Temperature coefficient θ for denitrif. rate	–	1.08–1.09
	O_2 economy	$mgO_2/mgNO_3^-$	2.86
	Alkalinity economy	$mgCaCO_3/mgNO_3^-$	3,5

See Sections 35.3 and 35.4 for interpretation of the values

Source: Eckenfelder and Argaman (1978), Arceivala (1981), Barnes and Bliss (1983), Sedlak (1991), Metcalf and Eddy (1991), Randall *et al.* (1992), EPA (1993) and Orhon and Artan (1994)

modelling, discussed in Sections 35.3 and 35.4. The design criteria for sequencing batch reactors are presented in Chapter 37.

36.1.4 Design considerations

Specific design aspects for activated sludge plants with biological nitrogen removal are presented next. The information was extracted from Randall *et al.* (1992) and EPA (1993).

(a) Primary sedimentation

Primary sedimentation offers the usual advantages related to systems without biological nutrient removal, such as reduced volume of the reactor and reduced aeration capacity needs, besides reduced floating materials and solids in the supernatant and drained liquids from the sludge processing units. However, the primary sedimentation reduces the BOD:TKN ratio, which may reduce the denitrification rate to be achieved. This may not be a problem if a large part of the influent BOD is soluble. A BOD₅:TKN ratio >5 favours denitrification. In case primary sedimentation is included, the detention time should be reduced, and conditions should be provided so that part of the raw sewage can be directly by-passed to the reactor to increase the organic carbon necessary for denitrification.

(b) Aeration systems

Mechanical and diffused air aeration systems can be used. The aeration capacity estimated in the design should comprise the carbonaceous and the nitrogenous demand under peak conditions. Plug-flow reactors should provide a larger aeration capacity in the inlet end of the tank. Point aerators, such as mechanical aerators, allow the occurrence of denitrification in the reactor itself, due to the possible presence of anoxic zones in the reactor, on the bottom and at corners of the reactor. Automatic control of the dissolved oxygen is advisable and, in most of the cases, necessary.

(c) Stirrers

In the anoxic zones, the stirrers should maintain the solids in suspension, but should avoid the aeration of the liquid mass. The most used types of stirrers are low speed devices, with either vertical shaft or submerged horizontal shaft. Submersible stirrers are more flexible, as they allow the adjustment of the level and direction of the mixing, although some models have not shown a good performance, making the vertical shaft stirrers to be more frequently used (Randall *et al.*, 1992). Stirrers are not essential in systems with intermittent aeration if the time with the aerators turned off is short. The power level of the stirrers varies from 5 to 10 W/m³, but the range of lower values does not guarantee good mixing between the influent and the recirculated liquids. It is advisable to mix them when they enter the anoxic zone. The location of the stirrers is crucial for the operation, and manufacturers should be consulted about that.

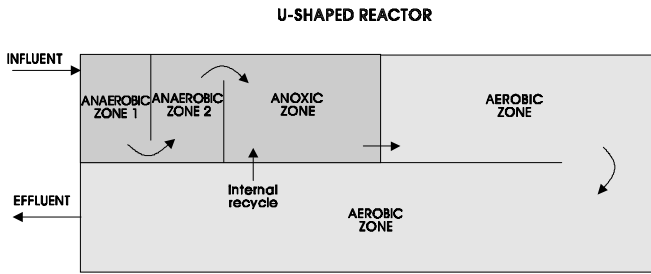

Figure 36.4. Configuration of a U-shaped reactor, with internal recirculation through the dividing wall between the anoxic and the aerobic zones

(d) Internal recirculation

Nitrate pumping from the aerobic zone to the anoxic zone is a characteristic of systems with pre-denitrification. This frequently requires pumping from the final end to the initial end of the reactor. The pumping line can be above the tank wall or even through it. Pumping through the wall can occur in U-shaped reactors, in which the inlet is located close to the outlet (see Figure 36.4).

The water level in the aerobic and anoxic zones is frequently approximately the same, which implies a very low pumping head. Centrifugal pumps can be used in smaller plants, but it is more advantageous to use low-speed, axial-flow pumps in larger plants, thus reducing the energy required and the introduction of oxygen into the anoxic zone. It is usually preferable to adopt a larger number of small pumps to allow a variable recycle flow.

(e) Reactor

The design of the anoxic and aerobic zones should allow flexibility in the entrance of the influent and recirculation lines. The anoxic zone can be divided into compartments by submerged walls. The U-reactor facilitates the internal recirculation, which can be achieved through the dividing wall between the anoxic and aerobic zones (see Figure 36.4).

(f) Secondary sedimentation tanks

Activated sludge plants with biological nutrient removal are susceptible to the same operational problems as those of the typical activated sludge system, besides other problems associated with the existence of the anoxic zone. Bulking sludge can occur, associated with several possible causes, including low DO concentrations and excessive detention times in the anoxic zone. The presence of scum is also possible, and plants with biological nutrient removal should be designed assuming the presence of scum, thus providing conditions for its removal in the secondary sedimentation tanks.

36.1.5 Design example of a reactor with nitrification and pre-denitrification

Design the reactor for biological nitrogen removal (nitrification and denitrification), in a conventional activated sludge system with *pre-denitrification* (anoxic zone followed by aerobic zone). The input data are the same as those of the example in Chapter 34. The data of interest are:

Raw sewage (see Section 34.1):

- Average influent flow: $Q = 9,820 \text{ m}^3/\text{d}$
- Influent TKN load = 496 kg/d
- Influent TKN concentration = 51 mg/L

Final effluent:

- Effluent TKN = 2 mg/L (desired)

Primary sedimentation tank (see Section 34.3.2):

- TKN removal efficiency in the primary sedimentation tank = 20%

Reactor (see Section 34.3.3):

- Sludge age = 6 d
- MLVSS = 3,000 mg/L
- DO in the reactor: $OD = 2 \text{ mg/L}$
- pH in the reactor: $\text{pH} = 6.8$
- Temperature of the liquid (average in the coldest month): $T = 20^\circ\text{C}$

Nitrification coefficients (adopted in this example – see Table 36.3):

- Maximum specific growth rate (μ_{\max}) (20°C) = 0.5 d^{-1}
- Ammonia half-saturation coefficient (K_N) = $0.70 \text{ gNH}_4^+/\text{m}^3$
- Oxygen half-saturation coefficient (K_O) = $0.80 \text{ gO}_2/\text{m}^3$
- Yield coefficient for nitrifiers (Y_N) = $0.08 \text{ gNitrif/gNH}_4^+ \text{ oxidised}$
- Temperature coefficient for $\mu_{\max}(\theta) = 1.1$
- O_2 demand for nitrification = $4.57 \text{ gO}_2/\text{gNH}_4^+ \text{ oxidised}$

Denitrification coefficients (adopted in this example – see Table 36.3):

- Denitrification rate in the pre-anoxic zone (20°C) = $0.08 \text{ kgNO}_3^-/\text{kgVSS}\cdot\text{d}$
- Temperature coefficient for the denitrification rate (θ) = 1.09
- O_2 production in denitrification = $2.85 \text{ g O}_2/\text{gNO}_3^- \text{ reduced}$
- Fraction of ammonia in the excess sludge = $0.12 \text{ kgNH}_4^+/\text{kgVSS}$

Reactor (values adopted in this example – see Table 36.2):

- Fraction of the reactor as pre-anoxic zone: 0.25 (25% of the volume of the reactor is a pre-anoxic zone)
- Fraction of the reactor as aerobic zone: 0.75 (75% of the volume of the reactor is an aerobic zone)

- Ratio between the BOD removal rate under anoxic and aerobic conditions: 0.7 (the BOD removal rate under anoxic conditions is 70% of the rate under aerobic conditions)
- Sludge recirculation ratio: 100%
- Internal recirculation ratio (aerobic zone to anoxic zone): 300%

All the TKN, NH_4^+ and NO_3^- concentrations are expressed in terms of nitrogen. The example uses indistinctively TKN and NH_4^+ to represent the ammonia at any point of the process.

Solution:

(a) TKN removal in the primary sedimentation

TKN removal efficiency in the primary sedimentation tank = 20% (input data)

$$\begin{aligned} \text{TKN}_{\text{eff. primary}} &= \text{TKN}_{\text{inf. prim.}}(100 - E)/100 = 496 \text{ kg/d}(100 - 20)/100 \\ &= 397 \text{ kg/d} = 51 \text{ mg/L} \cdot (100 - 20)/100 = 40 \text{ mg/L} \end{aligned}$$

The considerations made in Section 36.1.4.a, regarding the desirability of not having primary sedimentation in systems with biological nutrient removal, are also applicable here. However, for compatibility with the design already made in Chapter 34, the primary sedimentation tank is maintained here in the flowsheet of the plant.

(b) Volume of the reactor

According to the conception of the reactor, 25% of the total volume is represented by the anoxic zone and 75% is represented by the aerobic zone (see input data of the problem).

The sludge age can be divided as follows:

- *Total* sludge age = 6 d (input data to the problem)
- *Aerobic* sludge age = $6 \times 0.75 = 4.5$ d

Volume required for the reactor (calculated in Section 34.3.7): $V = 2,051 \text{ m}^3$

According to Table 36.2 and to what is stated in the example, the BOD removal rate in the anoxic zone is slower, being 70% of the removal rate in the aerobic zone. As 25% of the volume of this reactor consists of an anoxic zone, the total volume required should be multiplied by a correction factor:

$$\begin{aligned} V_{\text{tot}} &= V \cdot \frac{(F_{\text{anox}} + F_{\text{aer}})}{(0.7 \times F_{\text{anox}} + F_{\text{aer}})} = 2,051 \times \frac{(0.25 + 0.75)}{(0.7 \times 0.25 + 0.75)} \\ &= 2,051 \times 1.08 = 2,215 \text{ m}^3 \end{aligned}$$

Therefore, the total volume of the reactor should be multiplied by the correction factor 1.08, resulting in **2,215 m³**, instead of 2,051 m³.

The volumes of the anoxic and aerobic zones are:

- $V_{\text{anox}} = 0.25 \times 2,215 = 554 \text{ m}^3$
- $V_{\text{aer}} = 0.75 \times 2,215 = 1,661 \text{ m}^3$

The total hydraulic detention time is: $t = V/Q = 2,215/9,820 = 0.226 \text{ d} = 5.4 \text{ hours}$

The detention times in the anoxic and aerobic zones are:

- $t_{\text{anox}} = 0.25 \times 5.4 = 1.35 \text{ hours}$
- $t_{\text{aer}} = 0.75 \times 5.4 = 4.05 \text{ hours}$

The detention time in the pre-anoxic zone is within the range presented in Table 36.2.

The resultant sludge ages should also be multiplied by the correction factor 1.08:

- *Total* sludge age = $6.0 \times 1.08 = \mathbf{6.5 \text{ d}}$
- *Aerobic* sludge age = $4.5 \times 1.08 = \mathbf{4.9 \text{ d}}$

(c) Calculation of the growth rate of the nitrifying bacteria (μ_{max}) according to the environmental conditions in the reactor

The calculations below follow the methodology presented in Example 35.2 (although with data different from those of the referred to example).

Maximum specific growth rate: $\mu_{\text{max}} = 0.5 \text{ d}^{-1}$ (statement of the problem)

Influencing factors on μ_{max} (see statement of the problem):

- Ammonia concentration in the reactor: $\text{NH}_4^+ = 2 \text{ mg/L}$ (desired concentration for the effluent)
- DO concentration in the reactor: $\text{DO} = 2 \text{ mg/L}$
- pH in the reactor: $\text{pH} = 6.8$
- Temperature: $T = 20 \text{ }^\circ\text{C}$
- Effect of the ammonia concentration:

$$\mu = \mu_{\text{max}} \cdot \left[\frac{\text{NH}_4^+}{K_{\text{N}} + \text{NH}_4^+} \right] = 0.5 \cdot \left[\frac{2.0}{0.7 + 2.0} \right] = 0.37 \text{ d}^{-1}$$

(μ_{max} correction factor = $0.37/0.50 = 0.74$)

- Effect of the DO concentration in the reactor:
According to Equation 35.8 and Table 35.5:

$$\mu = \mu_{\text{max}} \cdot \left[\frac{\text{DO}}{K_{\text{O}} + \text{DO}} \right] = 0.5 \cdot \left[\frac{2.0}{0.6 + 2.0} \right] = 0.36$$

(μ_{max} correction factor = $0.36/0.50 = 0.72$)

- Effect of the pH in the reactor:

According to Equation 35.7:

$$\begin{aligned}\mu_{\max(\text{pH})} &= \mu_{\max}[1 - 0.83(7.2 - \text{pH})] \\ &= 0.5 \times [1 - 0.83 \times (7.2 - 6.8)] = 0.33\end{aligned}$$

(μ_{\max} correction factor = $0.33/0.50 = 0.66$)

- Effect of the temperature:

According to Equation 35.6, and adopting $\theta = 1.10$:

$$\mu_{\max(\text{T})} = \mu_{\max(20^\circ\text{C})} \cdot \theta^{(20-20)} = 0.50 \times 1.10^{(20-20)} = 0.50 \text{ d}^{-1}$$

(μ_{\max} correction factor = $0.50/0.50 = 1.00$) (without alteration, because the temperature is equal to the standard temperature)

- Integrated effect of the environmental conditions (multiple correction factor):

$$0.74 \times 0.72 \times 0.66 \times 1.00 = 0.35$$

The specific growth rate of the nitrifying bacteria under these environmental conditions is 35% of the maximum rate ($\mu_{\text{N}} = 0.35 \cdot \mu_{\max}$). Therefore, μ_{N} is:

$$\mu_{\text{N}} = 0.35 \times \mu_{\max} = 0.35 \times 0.50 = 0.18 \text{ d}^{-1}$$

(d) Minimum aerobic sludge age required for total nitrification

According to Equation 35.9, the minimum aerobic sludge age required for total nitrification is:

$$\theta_c = \frac{1}{\mu_{\text{N}}} = \frac{1}{0.18} = \mathbf{5.6 \text{ d}}$$

The aerobic sludge age obtained in the design is 4.9 days, therefore being lower than the minimum required value of 5.6 days to ensure full nitrification under the specified environmental conditions. The aerobic sludge age can be increased by increasing the volume of the aerobic zone, by increasing the MLVSS concentration, or by increasing the aerobic fraction of the reactor, until the minimum value required is reached. However, no changes are made in this example, and it is only verified whether the effluent ammonia concentration is still acceptable under these conditions.

(e) Calculation of the fraction of nitrifiers in the mixed liquor volatile suspended solids

The calculations below follow the methodology presented in Example 35.4 (although with data different from those of the referred to example).

- Net production of biological solids in the reactor:

Net $P_{xv} = 1.026 \text{ kgVSS/d}$ (calculated in Section 34.3.6.b; this value is not affected by the increased volume of the reactor, because the BOD load removed remained the same)

- Ammonia load to be oxidised:

Influent TKN load = $Q \cdot \text{TKN}_o = 9820 \times 40/1000 = 393 \text{ kg/d}$

Effluent TKN load = $Q \cdot \text{TKN}_e = 9820 \times 2/1000 = 20 \text{ kg/d}$

TKN load in the excess sludge = (ammonia fraction in the excess sludge) $\times P_{xv} = 0.12 \times P_{xv} = 0.12 \times 1,026 = 123 \text{ kg/d}$

TKN load to be oxidised = influent TKN – effluent TKN – TKN in excess sludge = $393 - 20 - 123 = 250 \text{ kg/d}$

- Production of nitrifying bacteria:

According to Equation 35.13, the production of nitrifying bacteria is:

$$P_{xN} = \Delta X_N / \Delta t = Y_N \cdot \text{TKN}_{\text{oxidised}} = 0.08 \times 250 = 20 \text{ kgX}_N/\text{d}$$

- f_N ratio

The f_N ratio, which corresponds to the fraction of nitrifying bacteria in the volatile suspended solids (X_N/X_V), can then be calculated by the quotient between the production of X_N and the production of X_V (Equation 35.11):

$$f_N = \frac{P_{xN}}{P_{xv}} = \frac{20}{1,026} = \mathbf{0.019 \text{ gX}_N/\text{gX}_V}$$

In this case, the nitrifying bacteria represent 1.9% of the total biomass (expressed as MLVSS).

(f) Calculation of the nitrification rate

According to Equation 35.15, the nitrification rate is given by:

$$\frac{\Delta \text{TKN}}{\Delta t} = f_N \cdot \frac{X_V \cdot \mu_N}{Y_N} = 0.019 \cdot \frac{3,000 \times 0.18}{0.08} = 128 \text{ gTKN/m}^3 \cdot \text{d}$$

The TKN load susceptible to being oxidised is (Equation 35.16):

$$L_{\text{TKN}} = \frac{V_{\text{aer}}}{10^3} \cdot \frac{\Delta \text{TKN}}{\Delta t} = \frac{1,661}{1,000} \times 128 = 213 \text{ kgTKN/d}$$

This value of 213 kgTKN/d is lower than the expected value to be oxidised (250 kgTKN/d, calculated in Item f above). Therefore, the concentration of effluent TKN will be higher than the concentration initially assumed (2 mg/L). If this value were higher than 250 kgTKN/d, the load liable to be oxidised would naturally be 250 kgTKN/d.

(g) Calculation of the concentration of effluent ammonia

- Calculation of the TKN loads:

Influent TKN load = 393 kg/d (calculated in Item e)

TKN load in the excess sludge = 123 kg/d (calculated in Item e)

TKN load liable to be oxidised = 213 kg/d (calculated in Item f)

Effluent TKN load = influent TKN – TKN in the excess sludge – TKN liable to be oxidised = 393 – 123 – 213 = 57kg/d

- Concentration of effluent TKN:

$$\text{TKN}_e = \frac{\text{effluent load}}{\text{flow}} = \frac{57 \times 1,000}{9,820} = \mathbf{6 \text{ mgTKN/L}}$$

The concentration of effluent TKN (or ammonia) in the system is, therefore, 6 mg/L. The value initially assumed had been 2 mg/L. Since this value influences the calculation of μ_N , the calculations of Item d can be redone by using the 6 mg/L concentration, and so forth, until a convergence is obtained, with an ammonia value between 2 and 6 mg/L. However, the difference obtained in this first iteration is not great, which justifies the fact that the iterative calculations are not made in this example.

(h) Ammonia removal efficiencies

The efficiency of the system in the removal of TKN is:

$$E = (\text{TKN}_o - \text{TKN}_e)/\text{TKN}_o = (51 - 6)/51 = 0.88 = \mathbf{88\%}$$

(i) Mass of VSS in the pre-anoxic zone

Volume of the pre-anoxic zone: $V_{\text{anox}} = 554 \text{ m}^3$ (calculated in Item b)

Mass of VSS in the pre-anoxic zone = $V_{\text{anox}} \cdot X_v/1000 = 554 \times 3,000/1,000 = 1,662 \text{ kgVSS}$

(j) Recirculation of nitrates to the anoxic zone

According to the statement of the problem:

- Sludge recirculation ratio: $R_{\text{sludge}} = 1.0$ (100%)
- Internal recirculation ratio (from the aerobic zone to the anoxic zone): $R_{\text{int}} = 3.0$ (300%)
- Total recirculation ratio: $R_{\text{tot}} = 1.0 + 3.0 = 4.0$

(l) Specific denitrification rate

$$\text{SDR} = 0.08 \text{ kgNO}_3^-/\text{kgVSS}\cdot\text{d} (20^\circ\text{C})$$

Correction for temperature (Equation 35.29):

$$\text{SDR}_T = \text{SDR}_{20^\circ\text{C}} \cdot \theta^{(T-20)} = 0.08 \times 1.09^{(20-20)} = 0.08 \text{ kgNO}_3^-/\text{kgVSS}\cdot\text{d}$$

No correction was necessary due to the fact that the average temperature of the liquid in the coldest month is 20 °C. Accordingly, there is no need for correction due to the presence of DO (Equation 35.27), since it is assumed that the DO in the anoxic zone is equal to zero.

(m) Nitrate loads

- Load of NO_3^- produced in the aerobic zone = load of oxidised TKN = 213 kg/d (calculated in Item g)
- Load of NO_3^- recirculated to the anoxic zone by the return of sludge = $213 \times R_{\text{sludge}}/(R_{\text{tot}} + 1) = 213 \times 1.0/(4.0 + 1) = 43 \text{ kg/d}$
- Load of NO_3^- recirculated to the anoxic zone by the internal recirculation = $213 \times R_{\text{int}}/(R_{\text{tot}} + 1) = 213 \times 3.0/(4.0 + 1) = 128 \text{ kg/d}$
- Load of total NO_3^- recirculated = $43 + 128 = 171 \text{ kg/d}$
- Load of NO_3^- liable to reduction in the pre-anoxic zone = $\text{SDR} \times \text{VSS mass} = 0.08 \times 1662 = 133 \text{ kg/d}$

As this value of 133 kg/d is lower than the total load recirculated (171 kg/d), the nitrate load to be really reduced will be **133 kg/d**. If the value of the load susceptible to reduction were higher than 171 kg/d, the load to be really reduced would naturally be 171 kg/d.

A means to increase the load susceptible to reduction would be to increase the MLVSS concentration or the volume of the anoxic zone. In this example, such changes are not made, and the concentration of effluent nitrate is calculated taking into account the conditions initially assumed.

- Load of effluent NO_3^- = Load of NO_3^- produced – Load of NO_3^- to denitrify = $213 - 133 = 80 \text{ kg/d}$

(n) Concentration of effluent nitrate

$$\text{NO}_{3\text{eff}} = \frac{\text{effluent load}}{\text{flow}} = \frac{80 \times 1,000}{9,820} = \mathbf{8 \text{ mgNO}_3^-/\text{L}}$$

Removal efficiency of the nitrate formed:

$$\begin{aligned} E &= (\text{load produced} - \text{effluent load})/\text{load produced} \\ &= (213 - 80)/213 = 0.62 = \mathbf{62\%} \end{aligned}$$

(o) Summary of the nitrogen concentrations

- Influent (raw sewage):

Total nitrogen = **51 mg/L** (assuming that the total nitrogen in the influent is the same as TKN)

- Final effluent:
Ammonia = **6 mg/L** (calculated in Item g)
Nitrate = **8 mg/L** (calculated in Item n)
Total nitrogen = 6 + 8 = **14 mg/L**

(p) Summary of the removal efficiencies

- Ammonia removal efficiency: $E = 88\%$ (calculated in Item h)
- Nitrate removal efficiency: $E = 62\%$ (calculated in Item n)
- Total nitrogen removal efficiency: $E = (51 - 14)/51 = 73\%$

These values meet the European Community's Directive (CEC, 1991) for discharge of urban wastewater in sensitive water bodies, for the population range between 10,000 inhabitants and 100,000 inhabitants, which means a total nitrogen concentration lower than 15 mg/L or a minimum removal efficiency between 70 and 80%. If the population were larger than 100,000 inhabitants, the total nitrogen removal should be optimised to allow the compliance with the stricter standard, which is, in this case, 10 mg/L of total nitrogen.

(q) Oxygen consumption

$$\begin{aligned} \text{O}_2 \text{ consumption for nitrification} &= 4.57 \times \text{load of TKN oxidised (Equation 35.17)} \\ &= 4.57 \times 213 \text{ kg/d} = \mathbf{973 \text{ kgO}_2/\text{d}} \end{aligned}$$

$$\begin{aligned} \text{O}_2 \text{ economy with denitrification} &= 2.86 \times \text{load of reduced NO}_3^- \text{ (Section 35.4.2.a)} \\ &= 2.86 \times 133 \text{ kg/d} = \mathbf{380 \text{ kgO}_2/\text{d}} \end{aligned}$$

36.2 BIOLOGICAL REMOVAL OF NITROGEN AND PHOSPHORUS

36.2.1 Processes most frequently used

This section presents a description of the main processes used for the combined removal of nitrogen and phosphorus. The processes employed for the removal of phosphorus alone are not discussed here, due to the difficulties they face in the presence of nitrates in the anaerobic zone. In warm-climate regions, nitrification occurs almost systematically in activated sludge plants. Thus, if an efficient denitrification is not provided in the reactor, a considerable amount of nitrates will be returned to the anaerobic zone through the recirculation lines, hindering the maintenance of strictly anaerobic conditions. For this reason, the removal of nitrogen is encouraged, even if, under some conditions, the removal of only phosphorus would be necessary in terms of the receiving body requirements.

The main processes used for the combined removal of N and P are (see Figure 36.5):

- A²O process (3-stage Phoredox)
- 5-stage Bardenpho process (Phoredox)

BIOLOGICAL REMOVAL OF NITROGEN AND PHOSPHORUS

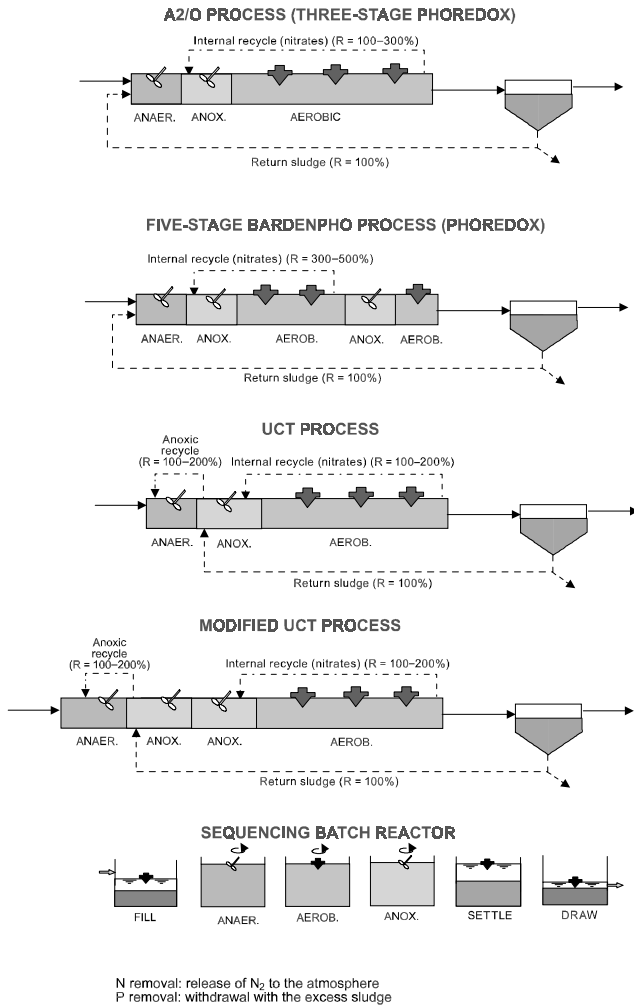

Figure 36.5. Main processes for the combined removal of nitrogen and phosphorus

- UCT Process
- Modified UCT Process
- Intermittent operation reactors (sequencing batch reactors)

The literature presents divergent nomenclature with relation to some processes, in view of variations between commercial and technical names. A brief description of the main variants is presented below (WRC, 1984; Sedlak, 1991).

(a) A²O Process (3-stage Phoredox)

The name A²O originates from ‘anaerobic/anoxic/aerobic’, which describes the basic flow line of the process. In other locations, this variant has been named Phoredox. Nitrogen removal results mainly from the internal recirculation from the aerobic zone to the anoxic zone. The alternation between anaerobic and aerobic conditions, necessary for phosphorus removal, is reached by means of the sludge recirculation, which is directed to the anaerobic zone. A high denitrification efficiency is required because the return of nitrates to the anaerobic zone can harm phosphorus removal.

(b) Five-stage Bardenpho process (Phoredox)

This process is similar to the four-stage Bardenpho (Section 36.1.1.c), with the inclusion of one anaerobic zone upstream. The returned sludge is directed to the anaerobic zone. The sludge age is usually higher than in other processes, ranging from 10 to 30 days.

(c) UCT Process (University of Cape Town)

The UCT process consists of three zones (anaerobic, anoxic and aerobic). The main aspect that distinguishes the UCT process from the others is that it prevents nitrates from returning to the anaerobic zone. In view of that, the recirculation of sludge is directed to the anoxic zone, and not to the anaerobic zone. There are two internal recirculations, as follows: (a) recirculation from the anoxic zone to the anaerobic zone ($R = 100$ to 200%), and (b) recirculation from the aerobic zone to the anoxic zone ($R = 100$ to 200%). The anoxic zone should provide denitrification capacity to the load of nitrates recirculated to avoid their return to the anaerobic zone. The VIP process (Virginia Initiative Plant) is similar to the UCT process.

(d) Modified UCT process

The modified UCT process separates the anoxic zone into two. The first zone receives the return sludge, and allows the recirculation from the anoxic zone to the anaerobic zone. This first zone is used to reduce only the nitrates from the sludge recirculation line. The second anoxic zone receives the internal recirculation from the aerobic zone, being the zone where most of the denitrification occurs. In separating this second anoxic zone from the first one, which recirculates to the anaerobic zone, the nitrate in excess can be recirculated without harming the process. To allow flexibility to operate as UCT or modified UCT process, the recirculation system to the anaerobic zone should be installed from both anoxic zones.

(e) Sequencing batch reactors

The sequencing batch process is similar to that described in Section 36.1.1.e., and includes, at the beginning of the operational cycle, an anaerobic stage. The sequence comprises the aerobic reaction, anoxic reaction, sedimentation and

Table 36.4. Capacity of the processes to meet different phosphorus discharge standards

Process	Effluent: 0.5 mgP/L				Effluent: 1.0 mgP/L				Effluent: 2.0 mgP/L			
	Biol		Biol + C		Biol		Biol + C		Biol		Biol + C	
	+ C	+ F	+ F	+ F	+ C	+ F	+ F	+ F	+ C	+ F	+ F	+ F
A ² O/3-stage Phoredox.	N	N	N	Y	V	Y*	V	Y	Y	Y	Y	Y
5-stage Bardenpho/Phoredox	N	N	N	Y	V	Y*	V	Y	Y	Y	Y	Y
UCT/VIP/Modif. UCT	N	N	N	Y	V	Y*	V	Y	Y	Y	Y	Y
Sequencing batch reactor	N	N	N	Y	V	Y*	V	Y	Y	Y	Y	Y

Biol = only biological treatment

Biol + F = biol. treatment. + filtration

N = No: does not comply with the P standard

Y = Yes: complies with the P standard

Source: Adapted from EPA (1987b)

Biol + C = biol. treatment + coagulant

Biol + C + F: = biol treatment. + coagulant + filtration

V = meets P standard in a variable or marginal form

Y* = meets P standard with a highly efficient clarification

Table 36.5. Typical concentrations of total nitrogen and ammonia in the effluent, and sensitivity to low BOD₅:P ratio values in the influent

Process	Ammonia (mg/L)	N total (mg/L)	Sensitivity to low BOD ₅ :P values (*)
A ² O/3-stage Phoredox.	<5	6–12	High
5-stage Bardenpho/Phoredox	<5	<6	High
UCT/VIP/Modif. UCT	<5	6–12	Low
Sequencing batch reactor	<5	6–12	Variable with the cycle

(*): desirable: values of the BOD₅:P ratio higher than 20

Source: Adapted from Sedlak (1991)

supernatant withdrawal phases. Further details on sequencing batch reactors are found in Chapter 37.

36.2.2 Selection among the biological nitrogen and phosphorus removal processes

Tables 36.4 and 36.5 present a comparison among the main processes used for biological phosphorus removal. Effluent polishing is also included, in case very high quality standards for the effluent are necessary. The effluent polishing processes considered are:

- *addition of coagulant agents* (metallic ions): phosphorus precipitation
- *filtration of the effluent*: removal of the phosphorus present in the suspended solids
- *combined addition of coagulants and filtration*

Table 36.6. Design criterion for biological nitrogen and phosphorus removal

Parameter	A ² O/3-stage		5-stage
	Phoredox	UCT/VIP	Bardenpho/ Phoredox
MLVSS (mg/L)	2000–4000	1500–3500	1500–4000
Total θ_c (d)	5–10	5–10	10–30
Aerobic θ_c (d)	≥ 5	≥ 5	≥ 8
HDT – anaerobic zone (hour)	0.5–1.5	1.0–2.0	1.0–2.0
HDT – 1 st anoxic zone (hour)	0.5–1.0	2.0–4.0	2.0–4.0
HDT – aerobic zone (hour)	3.5–6.0	2.5–4.0	4.0–12.0
HDT – 2 nd anoxic zone (hour)	–	–	2.0–4.0
HDT – final aerobic zone (hour)	–	–	0.5–1.0
BOD removal ratio – anoxic zone/ aerobic zone	0.7	0.7	0.7
Sludge recirculation ratio R_{sludge} (Q_r/Q) (%)	20–50	50–100	50–100
Aerobic to anoxic recirculation ratio (Q_{aer}/Q) (%)	100–300	100–200	300–500 ratio
Anoxic to anaerobic recirculation ratio (Q_{anox}/Q) (%)	–	100–200	–
Power level in the anoxic and anaerobic zones (W/m^3)	5–10	5–10	5–10
Average DO in the aerobic zone	2.0	2.0	2.0

Source: Adapted from IAWPRC (1987), Metcalf and Eddy (1991), Randall *et al.* (1992), EPA (1987b, 1993)

36.2.3 Design criterion for the biological removal of nitrogen and phosphorus

The main design criteria and parameters for the design of activated sludge systems with biological removal of nitrogen and phosphorus are presented in Tables 36.6 and 36.7. The coefficients and rates related to nitrification and denitrification are listed in Table 36.3. The design of sequencing batch reactors is presented in Chapter 37.

Aspects of importance in the design and operation, which can affect the performance of the plant, are found in Section 35.5.2. Several considerations about design, covered in the section related to biological nitrogen removal (Section 36.1.4), are also valid for biological phosphorus removal.

36.2.4 Design example of a reactor for biological phosphorus removal

Design the anaerobic zone of the reactor from the example in Section 36.1.5, so that the system can also remove phosphorus biologically. The data of interest are:

Influent:

- Average influent flow: $Q = 9,820 \text{ m}^3/\text{d}$
- Phosphorus concentration in the raw sewage: $P_{\text{inf}} = 12 \text{ mg/L}$

Table 36.7. Typical values of the rates and kinetic and stoichiometric coefficients for the modelling of biological phosphorus removal

Coefficient or rate	Unit	Range or typical values
Fraction of rapidly biodegradable influent COD (f_{rb})	–	0.15–0.30 (raw sewage) 0.20–0.35 (settled sewage)
COD/BOD ₅ ratio in the influent	mgCOD/mgBOD ₅	1.7–2.4
Yield coefficient (Y)	mgVSS/mgBOD ₅	0.4–0.8
Coefficient of endogenous respiration of the biodegradable SS (K_d)	d ⁻¹	0.08–0.09
Biodegradable fraction of the VSS (X_b/X_v) (f_b)	mgSS _b /mgVSS	0.55–0.70 (conventional activated sludge) 0.40–0.65 (extended aeration)
VSS/SS (X_v/X) ratio	mgVSS/mgSS	0.70–0.85 (conventional activated sludge) 0.60–0.75 (extended aeration)

Use of the coefficients and rates: see Item 35.5.3

Source: WRC (1994), von Sperling (1996a, 1996b). See also Tables 32.1 and 32.2

- Phosphorus removal efficiency in the primary sedimentation: 20% (adopted)
- BOD concentration in the settled sewage: BOD = 239 mg/L (calculated in Section 34.3.2)
- COD/BOD ratio in the influent = 1.8 (adopted)
- Rapidly biodegradable fraction of the influent COD: $f_{rb} = 0.25$ (Table 36.7, system with primary sedimentation)

Coefficients and ratios:

- Y = 0.6 mgVSS/mgBOD (adopted in Section 34.2.a)
- $K_d = 0.08$ d⁻¹ (adopted in Section 34.2.a)
- SS_b/VSS ratio: $f_b = 0.73$ mgSS_b/VSS (calculated in Section 34.3.3)
- VSS/SS ratio in the reactor: VSS/SS = 0.77 (calculated in Section 34.3.6.c)

Reactor:

- Sludge age: $\theta_c = 6$ d (adopted in Section 34.3.1.b)

Effluent:

- Effluent soluble BOD: S = 4 mg/L (calculated in Section 34.3.3)
- Suspended solids: SS_{eff} = 30 mg/L (adopted in Section 34.1)

Solution:

(a) Removal of P in the primary sedimentation tank

The concentration of P in the effluent from the primary sedimentation tank is:

$$P_{\text{eff prim}} = P_{\text{inf prim}} \cdot (100 - E)/100 = 12 \times (100 - 20)/100 = 9.6 \text{ mg/L}$$

(b) Volume of the anaerobic zone

The volume of the reactor with nitrogen removal, determined in Example 36.1.5.c, is 2,215 m³, with a total hydraulic detention time of 5.4 hours (pre-anoxic and aerobic zones).

From Table 36.6, a hydraulic detention time in the anaerobic zone of 1.2 hours may be adopted. The total detention time will then be:

$$t_{\text{tot}} = 5.4 + 1.2 = 6.6 \text{ hours}$$

The f_{an} ratio between the volume of the anaerobic zone and the total volume is proportional to the ratio between the detention times:

$$f_{\text{an}} = V_{\text{anaer}}/V_{\text{tot}} = 1.2/6.6 = 0.18$$

The volume of the anaerobic zone is:

$$V = t \cdot Q = 1.2 \times 9,820/24 = 491 \text{ m}^3$$

(c) Fraction of P in the suspended solids

- Influent COD:

$$\text{COD} = \text{BOD} \times (\text{COD/BOD ratio}) = 239 \times 1.8 = 430 \text{ mg/L}$$

- Propensity factor for phosphorus removal (Equation 35.30):

$$P_f = (f_{\text{rb}} \cdot \text{COD} - 25) \cdot f_{\text{an}} = (0.25 \times 430 - 25) \times 0.18 = 14.9$$

- Phosphorus fraction in the active biomass (Equation 35.31):

$$\begin{aligned} P/X_a &= 0.35 - 0.29 \cdot e^{-0.242 \cdot P_f} = 0.35 - 0.29 \cdot e^{-0.242 \times 14.9} \\ &= 0.34 \text{ mg P/mg } X_a \end{aligned}$$

- Ratio between active SS and volatile SS (Equation 35.32):

$$f_a = \frac{1}{1 + 0.2 \cdot K_d \cdot \theta_c} = \frac{1}{1 + 0.2 \times 0.08 \times 6} = 0.91 \text{ mg } X_a/\text{mg } X_v$$

- Fraction of P in the volatile suspended solids (Equation 35.35):

$$P/X_v = f_a \cdot (P/X_a) = 0.91 \times 0.34 = 0.31 \text{ mg P/mg VSS}$$

- Fraction of P in the total suspended solids (Equation 35.36):

$$P/X = \left(\frac{\text{VSS}}{\text{SS}} \right) \cdot f_a \cdot (P/X_a) = 0.77 \times 0.91 \times 0.34 = 0.24 \text{ mg P/mg SS}$$

This result indicates that the system is able to allow a high accumulation of P in the suspended solids of the excess sludge, representing 24% of the mass of the SS. In terms of design, it is more suitable to work with a safety factor. A maximum value of 7% is suggested in Section 35.5.4.a, which is usual in a large number of

wastewater treatment plants with biological phosphorus removal. Therefore, the P/X and P/X_v ratios should be corrected in view of this maximum suggested value of 0.07.

- Correction of the fraction of P in the total suspended solids, for the maximum limit of 7%

$$P/X = 0.07 \text{ mgP/mgSS}$$

- Correction of the fraction of P in the volatile suspended solids, for the maximum limit of 7% in the P/X ratio:

$$P/X_v = (P/X)/(VSS/SS) = 0.07/0.77 = 0.09 \text{ mgP/mgVSS}$$

(d) Removal of P with the excess sludge

- Concentration of P removed with the excess sludge (Equation 35.40):

$$\begin{aligned} P_{\text{rem}} &= \frac{Y}{1 + f_b \cdot K_d \cdot \theta_c} \cdot (P/X_v) \cdot (S_o - S) \\ &= \frac{0.6}{1 + 0.73 \times 0.08 \times 6} \times 0.09 \times (239 - 4) \\ &= 0.44 \times 0.09 \times 235 = 9.3 \text{ mgP/L} \end{aligned}$$

If this removal value (9.3 mg/L) were higher than the concentration of influent P to the biological stage (in this example, 9.6 mg/L), it should be assumed that the removal is equal to the influent concentration, that is, generating a concentration of effluent soluble P equal to zero.

(e) Effluent P concentrations

- Effluent soluble P (Equation 35.41):

$$P_{\text{sol eff}} = P_{\text{tot inf}} - P_{\text{rem}} = 9.6 - 9.3 = \mathbf{0.3 \text{ mgP/L}}$$

- Effluent particulate P (present in the effluent SS) (Equation 35.42):

$$P_{\text{part eff}} = SS_{\text{eff}} \cdot (P/X) = 30 \times 0.07 = \mathbf{2.1 \text{ mgP/L}}$$

- Effluent total P (Equation 35.43):

$$P_{\text{tot eff}} = P_{\text{sol eff}} + P_{\text{part eff}} = 0.3 + 2.1 = \mathbf{2.4 \text{ mgP/L}}$$

It is observed that most of the effluent phosphorus is associated with the effluent SS. If lower concentrations of P are desired, around 1 mg/L, a very efficient

secondary sedimentation should be adopted, or the SS removal should be supplemented by polishing with dissolved air flotation or sand filtration.

(f) P removal efficiency

- Total efficiency:

$$E = \frac{(P_{\text{inf}} - P_{\text{eff}})}{P_{\text{inf}}} \times 100 = \frac{(12.0 - 2.4)}{12.0} \times 100 = \mathbf{80\%}$$

Intermittent operation systems (sequencing batch reactors)

37.1 INTRODUCTION

Although use of intermittent operation reactors (sequencing batch reactors – SBR) started many decades ago, it was from the early 1980s that this technology became more widespread and used in the treatment of a larger diversity of effluents. This is partially due to a better knowledge of the system, to the use of more reliable effluent withdrawal devices, to the development of a more robust instrumentation and to the use of automated control by microprocessors. In the past few years, in view of the growing concern with the discharge of nutrients in watercourses, sequencing batch reactors have been modified to accomplish nitrification, denitrification and biological phosphorus removal.

37.2 PRINCIPLES OF THE PROCESS

The principle of the intermittent operation activated sludge process consists in the incorporation of all the unit operation and processes usually associated with the conventional treatment by activated sludge (primary sedimentation, biological oxidation and secondary sedimentation) in a single tank. Using a single tank, these processes and operations simply become sequences in time, and not separate units as in the conventional continuous-flow processes. The intermittent flow activated sludge process can also be used in the extended aeration mode, in which the single tank also incorporates sludge digestion.

Table 37.1. Stages in a typical operational cycle of sequencing batch reactor for carbon removal

Stage	Scheme	Aeration	Description
Fill		on/off	<ul style="list-style-type: none"> • The fill operation consists of the addition of sewage and substrate for microbial activity. • The fill cycle can be controlled by float valves to a pre-established volume or by timers for systems with more than one reactor. A simple method that is ordinarily applied to control the fill cycle is based on the volume of the reactor, resulting in fill times inversely related to the influent flow. • The fill phase can include several operational phases, and is subject to several control modes, named <i>static fill</i>, <i>fill with mixing</i>, and <i>fill with reaction</i>. • The <i>static fill</i> involves the introduction of the influent without mixing or aeration. This type of filling is more common in plants for nutrient removal. In these applications, the static fill is followed by a <i>fill with mixing</i>, so that the microorganisms are exposed to a sufficient amount of substrate, while anoxic or anaerobic conditions are maintained. Both mixing and aeration are performed in the <i>fill with reaction</i> stage. • The system can alternate among <i>static fill</i>, <i>fill with mixing</i> and <i>fill with reaction</i> throughout the operational cycle.
React		on	<ul style="list-style-type: none"> • The objective of the reaction stage is to complete the reactions started during the fill stage. • The reaction stage can comprise mixing, aeration or both. As in the case of the fill phase, the desired processes can require alternated aeration cycles. • The duration of the reaction phase can be controlled by timers, by the level of the liquid or by the degree of treatment, through the monitoring of the reactor. • Depending on the amount and duration of the aeration during the fill phase, there may or may not be a dedicated reaction phase.
Settle		off	<ul style="list-style-type: none"> • The solids–liquid separation occurs during the sedimentation phase, similar to the operation of a secondary sedimentation tank in a conventional plant. • The sedimentation in an intermittent system can be more efficient than in a continuous-flow sedimentation tank, due to more quiescent conditions of the liquid in a sequencing batch tank, with no interference of liquids entering and leaving.

Table 37.1 (Continued)

Stage	Scheme	Aeration	Description
Draw		<i>off</i>	<ul style="list-style-type: none"> The clarified effluent (supernatant) is removed during the draw phase. Drawing can be carried out by several mechanisms, the most frequently used ones being floating or adjustable weirs.
Idle		<i>on/off</i>	<ul style="list-style-type: none"> The final phase is named idle, and is only used in applications with several tanks. The main objective is to adjust the operational cycle of one reactor with the operational cycle of another reactor. The time intended for the idle phase depends on the time required by the preceding tank to complete its cycle. Wastage of excess sludge usually happens in this phase.

Source: Adapted from EPA (1993)

The process consists of complete-mix reactors where all treatment stages occur. This is attained by the establishment of operational cycles with defined duration. The biological mass remains in the reactor during all the cycles, thus eliminating the need for separate sedimentation tanks and sludge recirculation pumping stations. This is the essence of a sequencing batch reactor: biomass retention without the need for sludge recirculation by pumping. By preserving the biomass in the system, the sludge age becomes higher than the hydraulic detention time, which is a fundamental feature of the activated sludge process. The usual stages in the treatment cycle are summarised in Table 37.1.

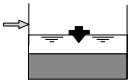
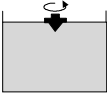
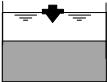
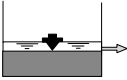
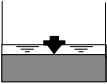
The usual duration of each cycle can be altered in view of the variations of the influent flow, the treatment requirements and the characteristics of the sewage and biomass in the system.

The excess sludge is generally wasted during the last phase (*idle*). However, since this phase is optional, because its purpose is to allow an adjustment among the operational cycles of each reactor, the wastage may occur in other phases of the process. The quantity and frequency of the sludge wastage are established according to the performance requirements, as in conventional continuous-flow processes.

The plant usually has two or more sequencing batch reactors operating in parallel, each one in different stages of the operational cycle. This need is compulsory in systems that receive inflow during all day (such as domestic sewage), because a reactor in the sedimentation stage, for example, is not able to receive influent. At this time, the influent is being directed to another reactor, which is in the fill phase. In plants receiving wastewater intermittently, such as in industries that work only 8 hours per day, there may be just one reactor, that works in fill (and possibly react) phase for 8 hours, and carries out the other stages of the cycle in the subsequent 16 hours. Figure 37.1 shows schematically a plant with three sequencing batch reactors in parallel.

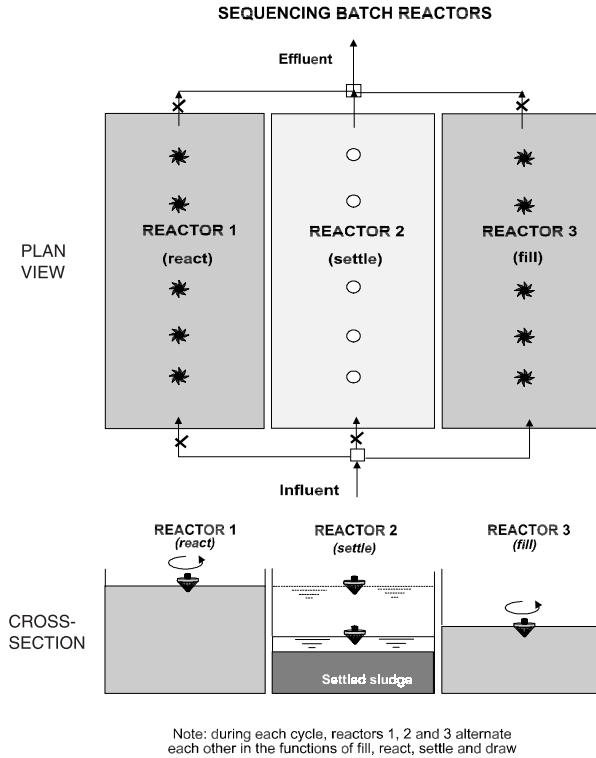

Figure 37.1. Arrangement with three sequencing batch reactors in parallel

37.3 PROCESS VARIANTS

Several modifications have been incorporated into the process, in order to achieve different objectives in the wastewater treatment. These changes refer both to the form of operation of the system (continuous feeding and discontinuous drawing) and to the sequence and duration of the cycles associated with each phase of the process. The variations presented can also be used for the treatment of industrial effluents (Goronszy, 1997). Examples of process variants are presented next, some of them being protected by patent.

(a) Sequencing batch reactor for biological nitrogen removal

Biological nitrogen removal can be reached by the incorporation of an anoxic stage after the aerobic reaction stage (Figure 37.2). In this case, there is a post-denitrification stage, which can be easily accomplished, although it occurs under endogenous respiration conditions, that is, at lower denitrification rates, due to the smaller availability of organic carbon.

If very low nitrogen values are not required, then a post-anoxic stage will not be necessary. In this case, a substantial amount of nitrate can be removed in a

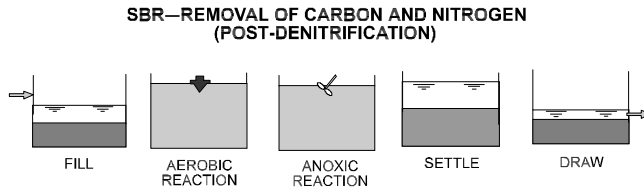

Figure 37.2. Sequencing batch reactor for removal of carbon and nitrogen (post-denitrification)

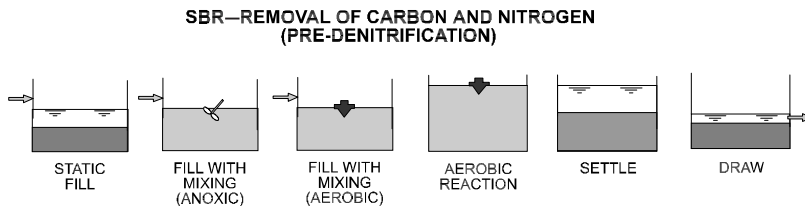

Figure 37.3. Sequencing batch reactor for the removal of carbon and nitrogen (pre-denitrification)

pre-anoxic period during fill, and the carbon from the raw sewage will be used for pre-denitrification (Figure 37.3). The ratio between the fill volume and the total volume of the reactor determines the maximum level that nitrogen removal can be reached. The lower the ratio between the fill volume and the total volume, the larger the nitrogen removal, assuming that all the nitrate is reduced prior to the beginning of aeration (Randall *et al.*, 1992).

(b) Sequencing batch reactor for biological phosphorus removal

The adaptation of the process for biological removal of phosphorus is made by the creation of a sequence of anaerobic conditions followed by aerobic conditions, provided that there is sufficient rapidly biodegradable organic matter during the anaerobic phase. Thus, the basic configuration of the operational cycles for the removal of BOD and suspended solids, as presented in Table 37.1, is changed in order to incorporate an anaerobic period. In this configuration (Figure 37.4), the incorporation of BOD and the release of phosphorus occur during the anaerobic reaction phase, with subsequent excess phosphorus incorporation and carbon oxidation occurring during the aerobic reaction phase. The operation of the system under these conditions is able to reduce the total phosphorus levels to less than 1 mg/L in the effluent, with no need of supplementary addition of chemical products (WEF/ASCE, 1992).

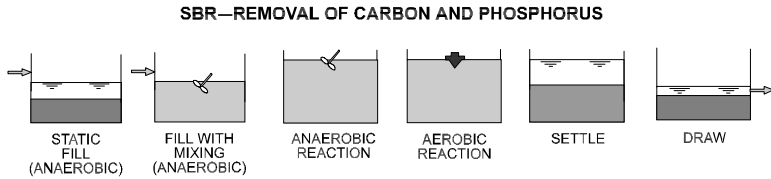

Figure 37.4. Sequencing batch reactor for the removal of BOD and phosphorus

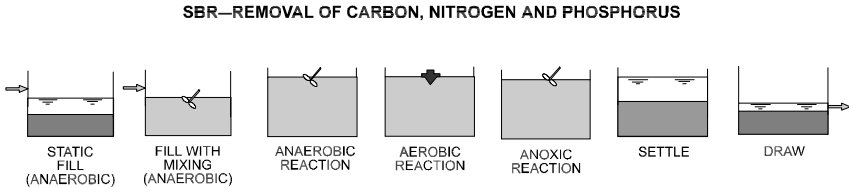

Figure 37.5. Sequencing batch reactor for the removal of BOD, nitrogen and phosphorus

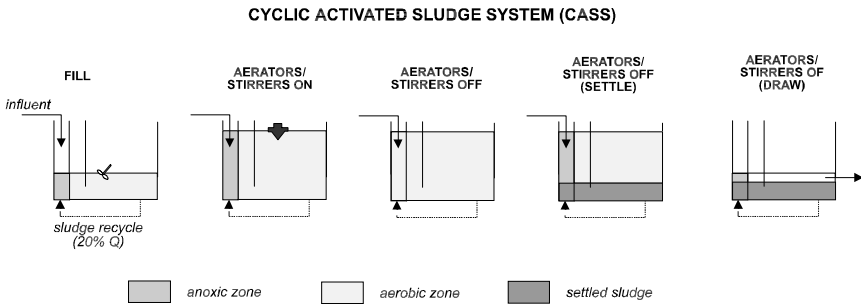

Figure 37.6. Cyclic Activated Sludge System (CASS)

(c) Sequencing batch reactor for biological removal of phosphorus and nitrogen

The operational cycles of the process can be modified to reach the combined oxidation of carbon and nitrogen and the removal of nitrate and phosphorus, as illustrated in Figure 37.5. The main difference is the incorporation of an anoxic phase after the aerobic reaction phase. Simultaneous removal of N and P is advantageous: if the system nitrifies but is not able to denitrify, the remaining nitrates will affect the conditions for creating a truly anaerobic environment during the anaerobic phase.

(d) Cyclic Activated Sludge System

The Cyclic Activated Sludge System (CASS) is patented. Its operation is similar to that of other intermittent systems (see Figure 37.6). The differentiating element is

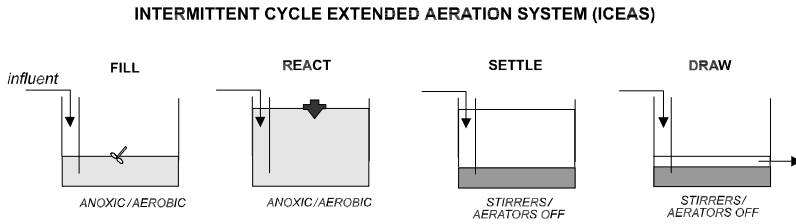

Figure 37.7. Intermittent Cycle Extended Aeration System (ICEAS)

the incorporation of a selector (see Chapter 39 for the concept of selectors), which can receive a continuous inflow. The selector is a baffled compartment, where the raw or settled sewage is mixed with return sludge (non-existent in most of the SBR versions). The liquid effluent from the selector enters the reaction zone. When limiting or eliminating the aeration in the selector, the organic matter concentration is high and oxygen becomes deficient. These conditions apparently favour the growth of floc-forming bacteria and the inhibition of filamentous bacteria, which improves the settleability of the sludge (EPA, 1993).

(e) Intermittent Cycle Extended Aeration System

The *Intermittent Cycle Extended Aeration System* (ICEAS) is patented (see Figure 37.7). Its main characteristic is that there is entrance of influent in all the stages of the cycle, differently from other variable volume variants. The inlet compartment aims at ensuring that the flow and load variations are evenly distributed among the reactors, preventing peak flows or shock loads from continuously overloading a tank. Another advantage of the continuous-flow regime of the ICEAS is the simplified control of the inflow, compared with other intermittent inflow variants. As there is influent entrance all the time, the ICEAS does not provide total quiescence during the sedimentation phase, differently from the intermittent flow versions. The ICEAS also uses an anoxic selector to allow denitrification and promote the growth of floc-forming bacteria, inhibiting the filamentous bacteria (EPA, 1993).

(f) Alternated aeration activated sludge system

This variant has been patented by the Federal University of Minas Gerais, Brazil, and further details of the process can be found in von Sperling (2002). The inflow and outflow are continuous and the water level is constant, which are advantages of the continuous-flow systems. There is an increase in the total reactor volume from 33 to 50% (compared with reactors from continuous-flow activated sludge systems) to account for the volume of sedimentation. Figures 37.8 and 37.9 illustrate the conception and the operating principle of the system.

In this system, the reactor is divided into, say, three reactors, with communicating openings among them, which guarantees the constant water level in all chambers. The reactors have a high length/breadth ratio, with the influent entering

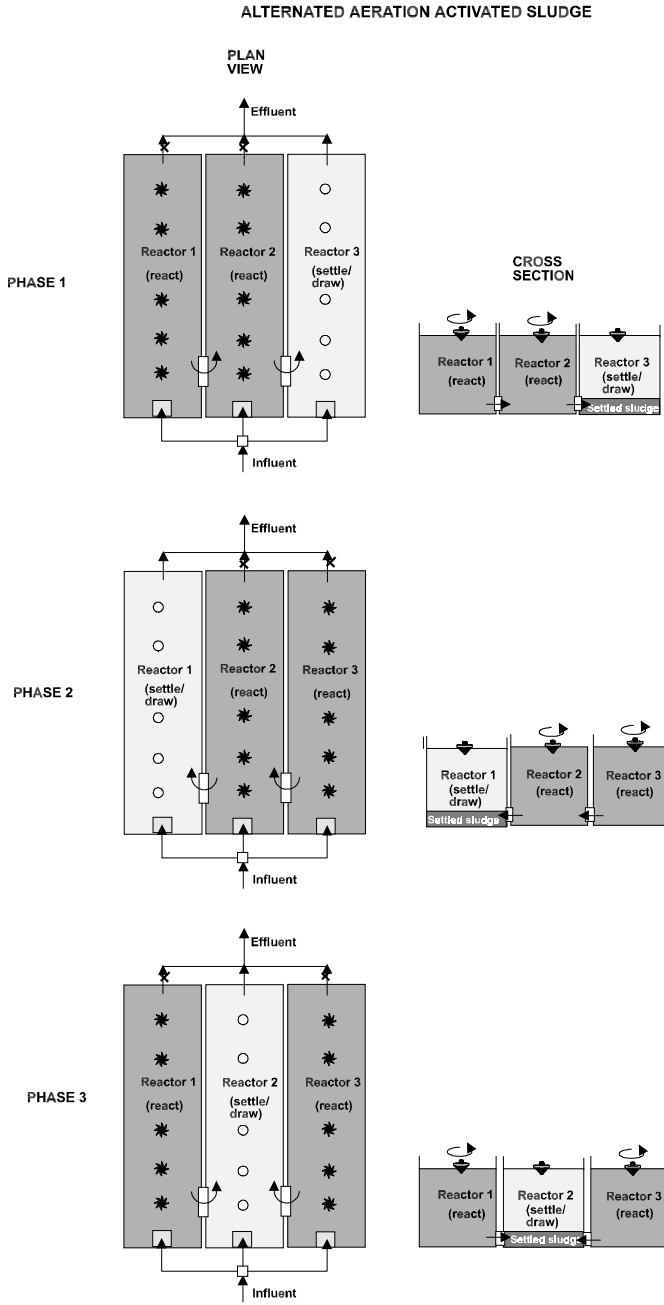

Figure 37.8. Alternated aeration activated sludge, composed of three reactors

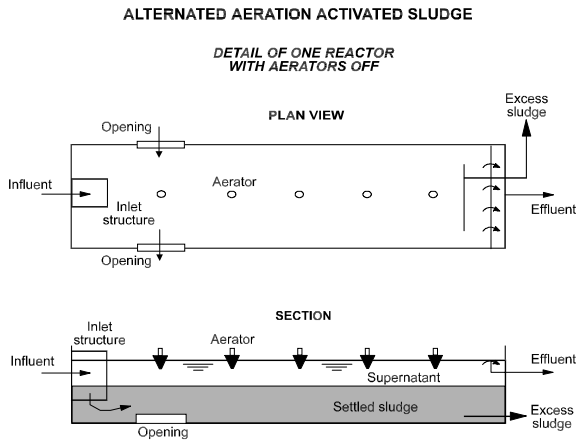

Figure 37.9. Schematics of a reactor from the alternated aeration activated sludge system

simultaneously in the inlet end of all reactors. The effluent leaves from one reactor at a time (alternately), at the opposite end of the tank. The aeration system in the three reactors operates in an intermittent and alternated basis. In one reactor the aerators are switched off, in which occasional solids settlement takes place, followed by the supernatant (effluent) withdrawal. In the other reactors the aerators are switched on, the biomass is in suspension, and the biochemical reactions take place. In these reactors, in which the biomass is suspended, there is no effluent withdrawal. After a certain period, the reactors in sedimentation and in reaction alternate in such a way that at the end of the cycle, all reactors have performed the roles of reaction and sedimentation/withdrawal.

Because there is only one reactor in sedimentation, while the other two are under reaction, it may be assumed that this reactor corresponds to the secondary sedimentation tank, with an increase of 50% (or 1 in sedimentation/2 in reaction) of the total volume required for reaction. In case the system has a total of four reactors, with only one under sedimentation, the increase will be of only 33% (1 in sedimentation/3 in reaction).

Depending on the treatment objectives, other phases can be incorporated, such as anoxic and anaerobic, for biological nutrient removal.

37.4 DESIGN CRITERIA FOR SEQUENCING BATCH REACTORS

The design criteria for the traditional **sequencing batch reactor** (intermittent inflow and outflow), as described in Section 37.2, are presented below. The design of the reactor uses the basic criteria and parameters of the continuous-flow activated sludge systems, with special considerations on the hydraulic and organic loading aspects. Thus, the determination of the volume of the reactor should meet

the following aspects: (a) kinetic criteria for carbon (and nitrogen and phosphorus, if applicable) removal, and (b) need to adapt the operating cycles to the influent flows (Chernicharo and von Sperling, 1993).

(a) Sludge age

The sludge age can be adopted according to the wide range available for the continuous-flow systems, that is, covering the conventional and extended aeration modes. The desirability to remove nutrients or not should also be taken into consideration. Examples of different sludge ages can be:

- $\theta_c = 4\text{--}6$ days: conventional mode, with no nutrient removal
- $\theta_c = 8\text{--}10$ days: conventional mode, with nutrient removal
- $\theta_c = 20\text{--}25$ days: extended aeration mode, with nutrient removal

However, due to the pursuit of operational simplicity in the sequencing batch reactors, a more convenient design of small- and medium-sized plants should adopt an extended aeration sludge age. EPA (1993) suggests 20 days to 40 days. However, in warm climate regions it is not necessary to adopt sludge ages higher than 30 days, in order to achieve sludge stabilisation. In the extended aeration mode, the whole treatment system may consist of only preliminary treatment, reactor, and sludge dewatering. Should nutrient removal be required, the conventional sludge ages provide higher removal efficiency.

(b) MLVSS concentration

The concentration of suspended solids during the reaction phase can be adopted similarly to the concentration of MLVSS in continuous-flow systems. If a safe positioning is desired, a slightly lower concentration can be adopted. EPA (1993) suggests concentrations of MLVSS between 1500 mg/L and 3500 mg/L.

(c) Operational cycles

According to WEF/ASCE (1992), the operational cycles vary widely, from approximately 6 to 48 hours. Generally, older systems have more conservative design criteria (longer cycles), while the systems designed more recently have shorter cycles, ranging from 6 to 12 hours. This optimisation has been achieved due to a deeper knowledge and greater control of the process, as well as to the automation of the system. Total operational cycles recommended by EPA are as follows (1993):

- conventional system: 4 to 6 hours
- system with biological nutrient removal: 6 to 8 hours

EPA (1993) proposes the division of the operational cycle according to the stages listed in Table 37.2.

Depending on the diurnal variations of the influent flows to the system, which can sometimes increase (minimum flow periods) and sometimes decrease (maximum flow periods) the reactor fill time, the operational cycles can have durations longer than those recommended. The automation level of the system also interferes with the duration of the operational cycles.

Table 37.2. Duration of each stage of the cycle, according to different removal purposes

Stage	Extended aeration BOD removal		Extended aeration BOD and N removal	
	Duration (hour)	% of the total	Duration (hour)	% of the total
Fill	1.0	23.8	1.0	21.3
Fill with mix	0.5	11.9	0.5	10.6
Fill with aeration	0.5	11.9	0.5	10.6
Aerobic/anoxic react	0.5	11.9	1.0	21.3
Settle	0.7	16.7	0.7	14.8
Draw	0.5	11.9	0.5	10.6
Idle	0.5	11.9	0.5	10.6
Total	4.2	100.0	4.7	100.0

Source: EPA (1993)

(d) Mathematical model

In the design of a *continuous-flow* activated sludge system, the mathematical model of the reactor uses the detention time values in the anaerobic, anoxic and aerobic zones to estimate the quality of the effluent and the oxygen requirements. In these conditions, several mathematical models available in the literature can be adopted. Chapters 9, 31 and 35 present a simplified mathematical model for continuous-flow systems.

In *intermittent flow* systems, the mathematical model can use the time allocated for each stage of the cycle (anaerobic, anoxic and aerobic) to do the same estimates. The degree of uncertainty in the application of the model is higher in intermittent systems because the reactions do not occur in physically different zones, but in different periods of time. Thus, some reactions may be overlapped within the same period. However, it is believed that the order of magnitude of the results achieved by using a generic model can be maintained. Thus, the effluent quality can be estimated by using the C, N and P removal models described in this book, and by making the adaptations mentioned above, that is, converting the detention times in the reactor zones into times for each stage in the cycle. The design should be flexible enough to allow operation to tune the cycles in order to achieve the best effluent quality.

(e) Aeration equipment

Aeration in sequencing batch reactors can be achieved by means of diffusers, floating aerators, jet aerators and aspirating aerators. The systems provided with diffusers should not allow clogging during settle, draw and idle periods. The mechanical aerators should be floating because of the variation of the water level throughout the operational cycle (fill and draw). For design purposes, it should be considered that the whole oxygen demand for stabilisation of the organic matter should be satisfied during the reaction phase. Thus, the power of the equipment

installed in each reactor should be enough to supply the whole oxygen mass required during a shorter time interval (aeration phase).

Consequently, the installed power is higher than the consumed power. The consumed power can be estimated by means of the usual calculation methods of oxygen requirements, while the installed power should take into consideration the ratio between the total cycle time and the time with the aerators turned on. For example, in a system with a 12-hour cycle, in which 6 hours are with the aerators turned on (aerobic fill + aerobic reaction), the ratio between total time/time with aerators turned on will be $12/6 = 2$. In these conditions, the installed power should be twice higher than the consumed power.

(f) Supernatant removal device

The removal of the clarified supernatant, without causing the suspension of the settled solids, is an item of great importance in the operational performance of a sequencing batch reactor. Fixed and floating outlet structures have been used, but the latter ones are more appropriate, as they can follow the water level, extracting the most superficial and, therefore, the most clarified layer (baffles may be installed for scum retention). Several floating mechanisms have been used, provided with flexible hoses or articulated mechanisms connected with the floating weirs.

37.5 DESIGN METHODOLOGY FOR SEQUENCING BATCH REACTORS

A sequence of calculations proposed by the author for estimating the volume of the reactor and the duration of the operational cycles of sequencing batch reactors (conventional reactor, with intermittent flow and variable level) is presented below. This methodology has been proposed by von Sperling (1998). Other methodologies are presented and exemplified in Eckenfelder Jr. (1989), Metcalf and Eddy (1991), Randall *et al.* (1992), Orhon and Artan (1994), and Artan *et al.* (2001). All these latter methodologies adopt the SVI (Sludge Volume Index) for estimation of the concentration and volume of the settled sludge, while the methodology proposed by von Sperling (1998) uses the concept of the zone settling velocity to estimate the sedimentation time, the concentration and the volume of the settled sludge. Section 10.5 describes the concept of zone settling velocity. The methodology proposed focuses on an operational cycle intended for BOD removal (with no explicit removal of N and P), consisting of the following stages: *fill*, *react*, *settle*, *draw* and *idle*.

The height, volume and concentrations of interest in the design of sequencing batch reactors are presented in Figure 37.10.

(a) Input data

Sludge age (θ_c). The sludge age is related to the active time of the cycle, which corresponds to the fill and reaction periods. The sludge age can be adopted according to the comments in Section 37.4.a.

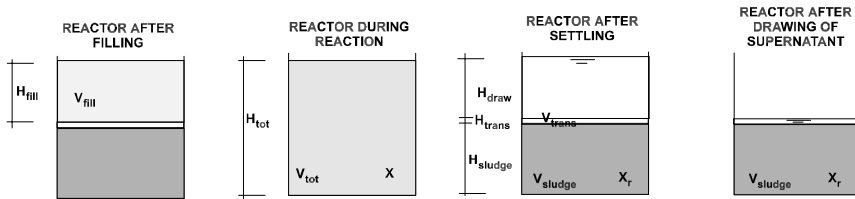

Figure 37.10. Height, volume and concentrations of interest in the design of a sequencing batch reactor

MLVSS concentration (X_v). The MLVSS concentration refers to the reaction stage, in which all solids are dispersed in the reactor. The MLVSS values can be adopted according to Section 37.4.b. The MLSS concentration is obtained by the usual manner, dividing MLVSS by the VSS/SS ratio in the reactor.

Kinetic and stoichiometric coefficients. The kinetic and stoichiometric coefficients (Y , K_d , f_b , and MLVSS/MLSS) can be adopted similarly as those of the continuous-flow activated sludge systems (see Table 32.2).

Number of cycles per day. The number of cycles per day (m) depends on the total time desired for the cycle. Thus, in case a total time of 6 hours is desired for the cycle, the number of cycles per day will be $(24 \text{ hours/d}) / (6 \text{ hours/cycle}) = 4 \text{ cycles/d}$.

Time of wastewater input to the plant. In the case of domestic sewage, the influent is assumed to arrive during 24 hours per day. In the case of industries that work only during one or two shifts per day, lower times can be adopted, in compatibility with the time of production of wastewater (e.g., 8 hours per day). In this case, 1 cycle/d can be adopted ($m = 1$), with a cycle duration of 8 hours.

Reactor height. The total height of the reactor (H_{tot}) (liquid depth) should be selected in view of the aeration equipment and the local conditions. According to Section 32.4, H_{tot} is usually within the following range: 3.5 to 4.5 m (mechanical aeration) and 4.5 to 6.0 m (diffused air).

(b) Design sequence

The design sequence is presented in this section in a summary table (Table 37.3), including all equations (von Sperling, 1998). The application of the equations can be more clearly understood in the design example in Section 37.6.

37.6 DESIGN EXAMPLE OF A SEQUENCING BATCH REACTOR

Design an extended aeration sequencing-batch-reactor system for the treatment of the wastewater from the general example in Chapter 34.

Table 37.3. List of equations and summary of the design sequence

Item to be calculated	Unit	Equation	Equation number
Number of cycles per day	–	m (adopt)	–
Total cycle time	hour	$T_{\text{total}} = \frac{24}{m}$	(37.1)
Time of arrival of influent during the cycle	hour	$T_{\text{arrival of influent during cycle}} = T_{\text{arrival influent during day}}/m$	(37.2)
Biodegradable fraction of the MLVSS	–	$f_b = \frac{0.8}{1+0.2 \cdot K_d \cdot \theta_c}$	(37.3)
Volume for reaction	m ³	$V_{\text{react}} = \frac{Y \cdot \theta_c \cdot Q \cdot (S_o - S)}{X_v \cdot (1 + f_b \cdot K_d \cdot \theta_c)}$	(37.4)
Fill volume	m ³	$V_{\text{fill}} = \frac{Q}{m}$	(37.5)
Transition volume	m ³	$V_{\text{trans}} = f_{H\text{fill}} \cdot V_{\text{fill}}$	(37.6)
Sludge volume	m ³	$V_{\text{sludge}} = V_{\text{react}}$	(37.7)
Total reactor volume	m ³	$V_{\text{tot}} = V_{\text{react}} + V_{\text{fill}} + V_{\text{trans}}$	(37.8)
Total reactor height	m	H_{tot} (adopt)	–
Fill height	m	$H_{\text{fill}} = \frac{V_{\text{fill}}}{\text{Area}} = \frac{V_{\text{fill}}}{(V_{\text{tot}}/H_{\text{tot}})}$	(37.9)
Transition height	m	$H_{\text{trans}} = f_{H\text{fill}} \cdot H_{\text{fill}}$	(37.10)
Sludge height	m	$H_{\text{sludge}} = H_{\text{tot}} - (H_{\text{fill}} + H_{\text{trans}})$	(37.11)
MLSS concentration	mg/L	$X = \frac{X_v}{(\text{SSV}/\text{SS})}$	(37.12)
MLSS mass in the reactor	kg	$M_x = \frac{X \cdot V_{\text{tot}}}{1000}$	(37.13)
SS concentration in the settled sludge	mg/L	$X_r = \frac{M_x \cdot 1000}{V_{\text{sludge}}}$	(37.14)
Number of reactors	–	n (adopt)	–
Volume of each reactor	m ³	$V_{\text{reactor}} = \frac{V_{\text{tot}}}{n}$	(37.15)
Fill time within cycle	hour	$T_{\text{fill}} = T_{\text{arrival of influent during cycle}}/n$	(37.16)
Active time within cycle (= fill time + react time)	hour	$T_{\text{active}} = T_{\text{total}} \cdot \frac{V_{\text{react}}}{V_{\text{tot}}}$	(37.17)
Reaction time within cycle	hour	$T_{\text{react}} = T_{\text{active}} - T_{\text{fill}}$	(37.18)
Settling velocity of the sludge interface	m/hour	$v = v_o \cdot e^{-K \cdot X}$	(37.19)
Settle time within cycle	hour	$T_{\text{settle}} = \frac{(H_{\text{trans}} + H_{\text{fill}})}{v}$	(37.20)
Supernatant withdrawal time within cycle	hour	$T_{\text{draw}} \text{ (adopt); } \leq T_{\text{total}} - (T_{\text{fill}} - T_{\text{react}} - T_{\text{settle}})$	(37.21)
Idle time within cycle	hour	$T_{\text{idle}} = T_{\text{total}} - (T_{\text{fill}} + T_{\text{react}} + T_{\text{settle}} + T_{\text{draw}})$	(37.22)
Number of effluent removals per day	–	Number removals per day = m·n	(37.23)
Volume of effluent in each removal	m ³	Vol. each removal = Q/(m·n)	(37.24)
Flow of effluent in each removal	m ³ /hour	Flow each removal = Vol. each rem./T _{draw}	(37.25)

Y = yield coefficient (gMLVSS/gBOD₅ removed) θ_c = sludge age (d)Q = inflow (m³d⁻¹)S_o = total influent BOD (mgL⁻¹)S = total effluent soluble BOD (mgL⁻¹)X_v = MLVSS concentration (mgL⁻¹)K_d = decay coefficient (d⁻¹)v_o, K = settling velocity equation coefficients (see Tables 33.2 and 33.3)

Source: von Sperling (1998)

Input data for the example*Influent and effluent characteristics:*

- Average inflow: $Q = 9,820 \text{ m}^3/\text{d}$
- Influent BOD concentration: $S_0 = 341 \text{ mg/L}$
- Effluent soluble BOD concentration (desired): $S = 9 \text{ mg/L}$

Coefficients:

- Yield coefficient: $Y = 0.6 \text{ mg/mg}$
- Endogenous respiration coefficient: $K_d = 0.08 \text{ d}^{-1}$
- SSV/SS ratio in the reactor: $SSV/SS = 0.69$

Design criteria:

- Sludge age: $\theta_c = 25 \text{ d}$ (extended aeration)
- MLVSS concentration (during reaction): $X_v = 2,415 \text{ mg/L}$
- Sludge settleability: between *fair* and *poor*
- Number of cycles per day: $m = 3$ (adopted)
- Number of reactors: $n = 3$ (adopted)
- Time with arrival of incoming sewage (per day) = 24 hours/d
- Total height of the reactor: $H_{\text{tot}} = 4.00 \text{ m}$

(a) Total cycle time

Equation 37.1:

$$T_{\text{total}} = \frac{24}{m} = \frac{24}{3} = 8 \text{ hours/cycle}$$

(b) Time of arrival of influent during each cycle

The time of wastewater input is not necessarily 24 hours/d, because there might be some cases in which the influent is generated during less than 24 hours/d (e.g., 8 hours/d), as is the case with some industries. From Equation 37.2, and considering the inflow for 24 hours/d (domestic sewage):

$$T_{\text{arrival of influent during cycle}} = T_{\text{arrival of influent during day}}/m = 24/3 = 8 \text{ hours}$$

(c) Volume of the reactor

- Volume for reaction (Equations 37.3 and 37.4):

The volume for reaction can be calculated using any suitable mathematical steady-state model for the continuous-flow activated sludge process. In this chapter, the model described in Chapters 9 and 31 (conventional equations

for continuous flow activated sludge) is used. From Equations 37.3 and 37.4:

$$f_b = \frac{0.8}{1 + 0.2 \cdot K_d \cdot \theta_c} = \frac{0.8}{1 + 0.2 \times 0.08 \times 25} = 0.57$$

$$V_{\text{react}} = \frac{Y \cdot \theta_c \cdot Q \cdot (S_0 - S)}{X_v \cdot (1 + f_b \cdot K_d \cdot \theta_c)} = \frac{0.6 \times 25 \times 9,820 \times (341 - 9)}{2,415 \times (1 + 0.57 \times 0.08 \times 25)}$$

$$= 9,463 \text{ m}^3$$

- Fill volume (Equation 37.5):

$$V_{\text{fill}} = \frac{Q}{m} = \frac{9820}{3} = 3,273 \text{ m}^3$$

- Transition volume (Equation 37.6):

Before starting the supernatant withdrawal, the sludge must settle a distance equal to the height of fill plus a transition height. This transition height is routinely included for safety in other design sequences available in the literature, and aims at avoiding the situation whereby the weir level coincides with the level of the settled sludge. By doing so, there will be a clarified transition layer, which will remain even after the supernatant withdrawal. The transition height H_{trans} is normally fixed as a fraction (f_{Hfill}) of the total fill height. The value of f_{Hfill} is usually adopted around 0.1 (H_{trans} is equal to 10% of H_{fill}).

$$V_{\text{trans}} = f_{\text{Hfill}} \cdot V_{\text{fill}} = 0.1 \times 3,273 = 327 \text{ m}^3$$

- Sludge volume (Equation 37.7):

$$V_{\text{sludge}} = V_{\text{react}} = 9,463 \text{ m}^3$$

- Total reactor volume (Equation 37.8):

$$V_{\text{tot}} = V_{\text{react}} + V_{\text{fill}} + V_{\text{trans}} = 9,463 + 3,273 + 327 = 13,063 \text{ m}^3$$

(d) Heights in the reactor

- Fill height (Equation 37.9):

$$H_{\text{fill}} = \frac{V_{\text{fill}}}{(V_{\text{tot}}/H_{\text{tot}})} = \frac{3,273}{(13,063 / 4.00)} = 1.00 \text{ m}$$

- Transition height (Equation 37.10):

$$H_{\text{trans}} = f_{\text{Hfill}} \times H_{\text{fill}} = 0.1 \times 1.00 \text{ m} = 0.10 \text{ m}$$

- Sludge height (Equation 37.11):

$$H_{\text{sludge}} = H_{\text{tot}} - (H_{\text{fill}} + H_{\text{trans}}) = 4.00 - (1.00 + 0.10) = 2.90 \text{ m}$$

(e) MLSS mass and concentration

- MLSS concentration in the reactor, during the *react* stage (Equation 37.12):

$$X = \frac{X_V}{(\text{SSV}/\text{SS})} = \frac{2,415}{0.69} = 3,500 \text{ mg/L}$$

- MLSS mass in the reactor (Equation 37.13):

$$M_x = \frac{X \cdot V_{\text{tot}}}{1,000} = \frac{3,500 \times 13,063}{1,000} = 45,721 \text{ kgSS}$$

(f) Average SS concentration in the settled sludge

SS concentration in the layer of settled sludge (Equation 37.14):

$$\begin{aligned} X_r &= \frac{M_x \cdot 1,000}{V_{\text{loso}}} = \frac{V_{\text{tot}} \cdot X}{V_{\text{tot}} \cdot (H_{\text{loso}}/H_{\text{tot}})} \\ &= \frac{X}{(H_{\text{loso}}/H_{\text{tot}})} = \frac{3,500}{(2,90 / 4,00)} = 4,828 \text{ mg/L} \end{aligned}$$

This concentration corresponds to the concentration of excess sludge, if it is removed during the idle stage.

(g) Times within the cycle

- Fill time (Equation 37.16):

$$T_{\text{fill}} = T_{\text{arrival of influent during cycle}}/n = 8/3 = 2.7 \text{ hours}$$

- Active time (Equation 37.17):

$$T_{\text{active}} = T_{\text{total}} \cdot \frac{V_{\text{react}}}{V_{\text{tot}}} = \frac{9,463}{13,063} = 5.8 \text{ hours}$$

- Reaction time (Equation 37.18):

$$T_{\text{react}} = T_{\text{active}} - T_{\text{fill}} = 5.8 - 2.7 = 3.1 \text{ hours}$$

- Settle time

Initially, the settling velocity of the sludge-liquid interface must be calculated. Assuming a settleability between *fair* and *poor*, as specified in the example, the coefficients v_o and K from Table 33.3 must be interpolated

between the values given for *fair* and *poor* settleability, resulting in:

$$v_o = (8.6 + 6.2)/2 = 7.40 \text{ m/hour}$$

$$K = (0.50 + 0.67)/2 = 0.59 \text{ m}^3/\text{kg}$$

The hindered settling velocity is a function of the sludge concentration, being thus given by (Equation 37.19):

$$v = 7.4 \cdot e^{(-0.59 \cdot X/1000)} = 7.4 \cdot e^{(-0.59 \times 3500/1000)} = 0.94 \text{ m/hour}$$

Time spent by the sludge-liquid interface to settle the distance $H_{\text{fill}} + H_{\text{trans}}$ (Equation 37.20):

$$T_{\text{settle}} = \frac{(H_{\text{trans}} + H_{\text{fill}})}{v} = \frac{0.10 + 1.00}{0.94} = 1.2 \text{ hours}$$

- Supernatant withdrawal time

The supernatant withdrawal time is adopted at this stage. The following constraint applies (Equation 37.21):

$$T_{\text{draw}} \leq T_{\text{total}} - T_{\text{fill}} - T_{\text{react}} - T_{\text{settle}}$$

$$T_{\text{draw}} = 0.5 \text{ hour (adopted)}$$

- Idle time (Equation 37.22):

The idle time is the time left to complete the cycle.

$$\begin{aligned} T_{\text{idle}} &= T_{\text{total}} - (T_{\text{fill}} + T_{\text{react}} + T_{\text{settle}} + T_{\text{draw}}) \\ &= 8.0 - (2.7 + 3.1 + 1.2 + 0.5) = 0.5 \text{ hour} \end{aligned}$$

(h) Summary of the duration of each phase in the cycle

Stage	Nomenclature	Duration (hours)	Percentage of the total cycle (%)
Fill	T_{fill}	2.7	33.8
React	T_{react}	3.1	38.8
Settle	T_{settle}	1.2	15.0
Draw	T_{draw}	0.5	6.2
Idle	T_{idle}	0.5	6.2
Total	—	8.0	100.0

(i) Effluent flow from each reactor

The effluent (supernatant) flow is different from the inflow to the reactor, because the effluent removal is concentrated on a shorter period. This larger instantaneous flow affects the dimensioning of the outlet structures and pipes.

The number of effluent removals per day is equal to the product of the number of cycles per day (m) and the number of reactors (n) (Equation 37.23):

$$\text{Number of removals per day} = m \cdot n = 3 \times 3 = 9 \text{ removals/d}$$

The average volume of each removal (m^3) corresponds to the average daily influent flow (Q) divided by the number of removals per day (Equation 37.24):

$$\text{Volume of each removal} = Q/(m \cdot n) = 9820/(3 \times 3) = 1,091 m^3/\text{removal}$$

The flow in each removal (m^3/h) is given by the quotient between the volume of each removal and the removal time (T_{draw}) (Equation 37.25):

$$\begin{aligned} \text{Flow of each removal} &= \text{Volume of each removal}/T_{\text{draw}} = 1,091/0.5 \\ &= 2,182 m^3/\text{hour} = 606 L/s \end{aligned}$$

(j) Oxygen requirements and sludge production

Refer to the calculation methodology presented in the example of the continuous-flow activated sludge system (Chapter 34).

When calculating the power requirements, it should be noted that the installed power should be greater than the consumed power. This is because the aerators have to transfer the oxygen required by the biomass during the time when they are switched on. Therefore, the required power must be multiplied by a factor equal to time with aerators on/total time. In this example, if the aerators are turned on only during the react phase, the time with aerators on will be 3.1 hours/cycle, and the total cycle time will be 8.0 hours/cycle. The correction factor is, therefore: $8.0/3.1 = 2.6$. The installed power needs to be 2.6 times greater than the consumed power.

Activated sludge for the post-treatment of the effluents from anaerobic reactors

38.1 DESIGN CRITERIA AND PARAMETERS

The main characteristics, applications, advantages and disadvantages of the systems composed of upflow anaerobic sludge blanket (UASB) reactors followed by the activated sludge system were presented in Chapter 30.

The present chapter, based on von Sperling *et al.* (2001) and on the results from the Brazilian Research Programme on Basic Sanitation (PROSAB), lists the main criteria and parameters used in the design of the post-treatment stage. The approach used here is simpler and more direct than that adopted in the previous chapters on this section on activated sludge. However, the results are not substantially different from those obtained using the more complete design sequences presented earlier. The mathematical model described in this book for BOD removal and determination of the required reactor volume, required power and sludge production can be applied to the present situation.

The main design parameters, which determine the behaviour of the system and the required volumes and areas, are (a) *reactor*: sludge age (θ_c) and mixed liquor volatile suspended solids (MLVSS) concentration; and (b) *secondary sedimentation tank*: hydraulic loading rate (HLR) and solids loading rate (SLR).

Table 38.1. Design parameters of activated sludge systems for the post-treatment of effluents from anaerobic reactors

Item	Parameter	Value	
<i>Aeration tank</i>	Sludge age (d)	6–10	
	F/M ratio (kg BOD/kgMLVSS·d)	0.25–0.40	
	Hydraulic detention time (hour)	3–5	
	MLVSS concentration (mg/L)	1,100–1,500	
	MLSS concentration (mg/L)	1,500–2,000	
	VSS/SS ratio in the reactor (–)	0.73–0.77	
	Biodegradable fraction of the VSS ($f_b = SS_b/VSS$)	0.68–0.74	
<i>Aeration system</i>	Average O ₂ requirements – carbonaceous demand (kgO ₂ /kgBOD rem)	0.80–0.94	
	Average O ₂ requirements–nitrogenous demand (kgO ₂ /kgTKN applied)	3.8–4.3	
	Average O ₂ requirements–nitrogenous demand (kgO ₂ /kgN available)*	4.6	
	Maximum O ₂ consumption/average O ₂ consumption ratio	1.2–1.5	
	Standard oxygenation efficiency (kgO ₂ /kW·hour)	1.5–2.2	
	Correction factor: standard oxygen. efficiency/field oxygen. efficiency	1.5–1.8	
	<i>Sludge production</i>	Product. excess AS sludge (returned to UASB) (kgSS/kgBODrem from AS)	0.78–0.90
Per capita product. of excess AS sludge (returned to UASB) (gSS/inhabitant·d)		8–14	
Concentration of SS in the AS sludge returned to the UASB (mg/L)		3,000–5,000	
Removal efficiency of VSS from the AS sludge in the UASB reactor		0.25–0.45	
Production of anaerobic sludge (kgSS/kgBOD applied to the UASB)		0.28–0.36	
Per capita production of anaerobic sludge (gSS/inhabitant·d)		14–18	
Production of total mixed sludge (to be dewatered) (kgSS/kgBOD applied)		0.40–0.60	
Per capita production of total mixed sludge (to be dewatered) (gSS/inhabitant·d)		20–30	
Per capita volumetric product. total mixed sludge (to be dewatered) (L/inhabitant·d)		0.5–1.0	
Concent. mixed sludge (AS + anaerobic) removed from the UASB (%)		3.0–4.0	
<i>Secondary sediment. tank</i>		Hydraulic loading rate (Q/A) (m ³ /m ² ·d)	24–36
		Solids loading rate [(Q + Q _r)·X/A] (kgSS/m ² ·d)	100–140
		Sidewater depth (m)	3.0–4.0
	Recirculation ratio (Q _r /Q)	0.6–1.0	
	Concentration of SS in the sludge recirculated to the aeration tank (mg/L)	3,000–5,000	
<i>Sludge treatment</i>	Per capita production of SS in the sludge to be disposed of (gSS/inhabitant·d)	20–30	
	Per capita volum. production of sludge to be disposed of (L sludge/inhabitant·d)	0.05–0.15	
	Solids content (centrifuge, belt press) (%)	20–30	
	Solids content (filter press) (%)	25–40	
	Solids content (sludge drying bed) (%)	30–45	

* N available for nitrification = influent TKN – N in excess sludge (10% of the excess VSS is N)
 AS: activated sludge

Table 38.1 lists the main design parameters used for the activated sludge process as post-treatment of effluents from anaerobic reactors.

Kinetic and stoichiometric coefficients. Regarding the values of the kinetic and stoichiometric coefficients (mainly Y and K_d), the same usual values of the classical configurations of the activated sludge system are used in this chapter. However, it should be highlighted that the values of these coefficients, applied to the specific case of activated sludge as post-treatment of effluents from anaerobic reactors, should be further investigated, due to the possible influence of the previous anaerobic treatment on the process kinetics.

Design parameters for the reactor. The design parameters for the activated sludge reactor as post-treatment are similar to those for the *conventional activated sludge* systems. The main difference lies in the lower MLSS concentration usually assumed for the post-treatment activated sludge. If higher values are adopted, the volume of the aeration tank will be very reduced (detention time shorter than 2.0 hours; no full-scale operational experience so far to demonstrate the process stability of such small tanks).

Design parameters for the secondary sedimentation tanks. The loading rates in the secondary sedimentation tanks of post-treatment activated sludge systems are presumably different from those in conventional activated sludge systems, since the former work with lower MLSS concentrations and with a sludge of slightly different characteristics. Besides that, the UASB reactors provide a certain smoothing in the flow to be treated, reducing the Q_{\max}/Q_{av} ratio in the influent to the sedimentation tanks. These are items that deserve continued investigations, with experience in full-scale wastewater treatment plants, to get specific design parameters for this configuration.

Nitrification. With respect to the removal of ammonia in the UASB-activated sludge system, it should be mentioned that there have been operational difficulties in the maintenance of full nitrification in the aerobic reactor. This fact is apparently associated with toxicity problems to the nitrifying bacteria, possibly caused by the presence of sulphides. For this reason, even in warm-climate regions, sludge ages equal to or greater than 8 days should be adopted, if nitrification is desired.

Biological nutrient removal. Post-treatment activated sludge systems are not particularly efficient in the removal of nitrogen, since there is little availability of organic carbon for the denitrifying bacteria, as a large fraction of the organic matter has been previously removed in the UASB reactor. A means of supplying organic carbon to the activated sludge reactor is by a partial by-pass to the UASB reactor, supplying raw sewage to the anoxic zone in the aeration tank. A similar comment can be made for the biological removal of phosphorus: the previous removal of a large fraction of the organic carbon in the UASB reactor hinders the biological P removal process. Similarly, a partial by-pass of the raw sewage may be helpful.

Sequencing batch activated sludge reactor. The design of a sequencing batch activated sludge reactor after an anaerobic reactor should propose an operational cycle that is suitable for the condition of low organic load in the influent to the aerobic stage. Designs that do not pursue an optimisation may lead to large fill volumes,

compared with the reaction volumes, which may result in an uneconomical, large volume of the aerobic reactor.

38.2 DESIGN EXAMPLE OF AN ACTIVATED SLUDGE SYSTEM FOR THE POST-TREATMENT OF THE EFFLUENT FROM A UASB REACTOR

Undertake a simplified design of a continuous-flow activated sludge system acting as post-treatment of the effluent from a UASB reactor. Determine the volume of the reactor, the oxygen consumption, the power of the aerators and the production and removal of excess sludge. Use the same input data as those in the general example in Chapter 34 (design of conventional activated sludge system) and the design parameters presented in Tables 38.1 and 30.3.

Input data:

- population equivalent: 67,000 inhabitants
- average influent flow: $Q = 9,820 \text{ m}^3/\text{d}$
- loads in the raw sewage:
 - BOD: 3,350 kg/d
 - SS: 3,720 kg/d
 - TKN: 496 kg/d
- concentrations in the raw sewage:
 - BOD: 341 mg/L
 - SS: 379 mg/L
 - TKN: 51 mg/L
- removal efficiencies in the UASB reactor (assumed):
 - BOD: 70%
 - TKN: 10%

The design of the UASB reactor is not presented here, being covered in Chapter 27.

Solution:

(a) Characteristics of the influent to the activated sludge (AS) stage

The influent to the activated sludge system is the effluent from the UASB reactor. Considering the removal efficiencies provided in the input data, one has:

- Influent BOD load AS = raw sewage BOD load $\times (1 - \text{UASB Efficiency}) = 3,350 \text{ kg/d} \times (1 - 0.70) = \mathbf{1,005 \text{ kgBOD/d}}$
- Influent BOD concentration AS = raw sewage BOD concentration $\times (1 - \text{UASB Efficiency}) = 341 \text{ mg/L} \times (1 - 0.70) = \mathbf{102 \text{ mgBOD/L}}$
- Influent TKN load AS = raw sewage TKN load $\times (1 - \text{UASB Efficiency}) = 496 \text{ kg/d} \times (1 - 0.10) = \mathbf{446 \text{ kgTKN/d}}$

- Influent TKN concentration AS = raw sewage TKN concentration \times (1 – UASB Efficiency) = 51 mg/L \times (1–0.10) = **46 mgTKN/L**

(b) Characteristics of the final effluent from the treatment plant

By adopting overall typical removal efficiencies for the UASB-activated sludge system presented in Table 30.3, the estimated concentrations in the final effluent of the treatment plant are as follows:

Parameter	Overall removal efficiency (%)	Concentration in the raw sewage (mg/L)	Estimated concentration in the final effluent (mg/L)
BOD	85–95	341	16–47
SS	85–95	379	19–57
TKN	75–90	51	5–13

$$\text{Effluent concentration} = \text{Influent concentration} \times (100 - \text{Efficiency})/100$$

(c) Design of the reactor

Design parameters adopted (see Table 38.1):

- Sludge age: $\theta_c = 8 \text{ d}$
- Mixed liquor volatile suspended solids: MLVSS = $X_v = 1,500 \text{ mg/L}$
- Effluent soluble BOD: $S = 10 \text{ mg/L}$ (adopted)

Coefficients adopted (see Table 32.2):

- $Y = 0.6 \text{ gVSS/gBOD}$
- $K_d = 0.08 \text{ gVSS/gVSS}\cdot\text{d}$

The biodegradable fraction of mixed liquor volatile suspended solids is given by (Equation 31.2):

$$f_b = \frac{0.8}{1 + 0.2 \cdot K_d \cdot \theta_c} = \frac{0.8}{1 + 0.2 \times 0.08 \times 8} = 0.71$$

The volume of the reactor is given by (Equation 31.4):

$$V = \frac{Y \cdot \theta_c \cdot Q \cdot (S_0 - S)}{X_v \cdot (1 + f_b \cdot K_d \cdot \theta_c)} = \frac{0.60 \times 8 \times 9,820 \times (102 - 10)}{1,500 \times (1 + 0.71 \times 0.08 \times 6)} = 1,988 \text{ m}^3$$

The volume of the reactor can also be calculated based on the F/M ratio concept, which does not require the knowledge of coefficients Y and K_d . By adopting an F/M value equal to 0.35 kgBOD/kgMLVSS·d (Table 38.1), the resulting reactor volume is:

$$V = \frac{Q \cdot \text{DBO}_{\text{influent AS}}}{X_v \cdot (F/M)} = \frac{9,820 \times 102}{1,500 \times 0.35} = 1,908 \text{ m}^3$$

It is observed that the volumes resulting from both calculations are very similar. In the remainder of the design, the value obtained from the calculation using the sludge age ($V = 1,988 \text{ m}^3$) is used.

Two tanks can be adopted, each one with a volume of $(1,988 \text{ m}^3)/2 = 994 \text{ m}^3$.

By adopting a depth of **3.5 m**, the surface area of each tank is $994 \text{ m}^3/3.5 \text{ m} = 284 \text{ m}^2$.

The length/breadth ratio can vary according to the layout and to the arrangement of the aerators (in case of mechanical aeration). For the purposes of this example, adopt:

Length **L = 30.0 m** and breadth **B = 9.5 m** (length/breadth ratio: **L/B = 3.2**)

The resulting total volume is **1,995 m³**.

The resulting HDT in the aeration tank is:

$$\begin{aligned} \text{HDT} &= V/Q = 1,995 \text{ m}^3/9,820 \text{ m}^3/\text{d} = 0.20 \text{ d} \\ &= \mathbf{4.8 \text{ hours}} \text{ (appropriate, according to Table 38.1)} \end{aligned}$$

The MLVSS/MLSS ratio ($= \text{VSS}/\text{SS} = X_v/X$) adopted in the aeration tank is 0.75 (see Table 38.1).

The MLSS concentration (X) in the aeration tank is:

$$\text{MLSS} = \text{MLVSS}/(\text{VSS}/\text{SS}) = (1,500 \text{ mg/L})/(0.75) = \mathbf{2,000 \text{ mg/L}}$$

(d) Production and removal of excess sludge

Coefficient of sludge production: 0.84 kgSS/kgBOD removed in the activated sludge (see Table 38.1 or Table 31.6 – sludge age of 8 days, with solids in the influent, with primary sedimentation tank, which, in this case, is replaced by the UASB reactor).

The BOD load removed from the aeration tank is:

$$\begin{aligned} \text{BOD load rem} &= Q \cdot (S_o - S) = 9,820 \text{ m}^3/\text{d} \times (102 - 10) \text{ g}/\text{m}^3 \\ &= 903,440 \text{ gBOD}/\text{d} = 903 \text{ kgBOD}/\text{d} \end{aligned}$$

The production of excess aerobic activated sludge is, therefore:

$$P_X = 0.84 \text{ kgSS}/\text{kgBOD} \times 903 \text{ kgBOD}/\text{d} = 759 \text{ kgSS}/\text{d}$$

In the activated sludge system as post-treatment for anaerobic effluents, the production of solids is low, due to the fact that the anaerobic reactor removes previously a large part of the substrate (BOD) required for biomass growth. In these conditions, the loss of solids in the final effluent should be taken into consideration when estimating the amount of solids to be wasted. Assuming an average

concentration of SS in the final effluent equal to 20 mg/L, the loss corresponds to:

$$\begin{aligned}\text{Loss of SS in the final effluent} &= 9,820 \text{ m}^3/\text{d} \times 20 \text{ g/m}^3 = 196,400 \text{ gSS/d} \\ &= 196 \text{ kgSS/d}\end{aligned}$$

The SS load to be intentionally wasted from the aerobic reactor and returned to the UASB reactor is, therefore:

$$\text{Production of SS} = P_X - \text{SS loss} = 759 - 196 = \mathbf{563 \text{ kgSS/d}}$$

The per capita production of aerobic activated sludge is:

$$\begin{aligned}\text{Per capita } P_X &= 563 \text{ kgSS/d}/67,000 \text{ inhabitants} = 0.008 \text{ kgSS/inhabitant}\cdot\text{d} \\ &= 8 \text{ gSS/inhabitant}\cdot\text{d} \text{ (appropriate, according to Table 38.1).}\end{aligned}$$

The distribution of the excess sludge in terms of volatile solids and fixed solids is a function of the VSS/SS ratio (equal to 0.75 in this example). Thus, the distribution is:

- Total suspended solids: $P_X = 563 \text{ kgSS/d}$
- Volatile suspended solids: $P_{XV} = (\text{VSS/SS}) \times P_X = 0.75 \times 563 = 422 \text{ kgVSS/d}$
- Fixed suspended solids: $P_{XF} = (1 - \text{VSS/SS}) \times P_X = (1 - 0.75) \times 563 = 141 \text{ kgFSS/d}$

The concentration of the excess aerobic activated sludge (AS) is the same as that of the return sludge, since the excess sludge is removed from the recirculation line. This concentration is a function of the MLSS concentration and the recirculation ratio $R (=Q_r/Q)$. In the example, $\text{MLSS} = 2000 \text{ mg/L}$ and R is adopted as **0.8** (see Table 38.1). The SS concentration in the excess aerobic sludge and in the return sludge (X_r) is:

$$\begin{aligned}X_r &= X \cdot (1 + R)/R = 2,000 \text{ mg/L} \times (1 + 0.8)/0.8 = \mathbf{4,500 \text{ mgSS/L}} \\ &= 4,500 \text{ gSS/m}^3 = 4.5 \text{ kgSS/m}^3\end{aligned}$$

The flow of excess aerobic activated sludge (AS) returned to the UASB reactor is:

$$\text{flow} = \text{load}/\text{concentration} =$$

$$Q_{\text{ex aerobic}} = (563 \text{ kgSS/d})/(4.5 \text{ kgSS/m}^3) = \mathbf{125 \text{ m}^3/\text{d}}$$

This flow is very low in comparison with the influent flow to the UASB reactor, representing only approximately **1.3%** ($125/9,820 = 0.013$), that is, the hydraulic impact of the return of the excess aerobic sludge to the UASB reactor is non-significant. On the other hand, the organic load in the excess sludge is estimated

to be 282 kgBOD/d (1 kg of SS generates approximately 0.5 kgBOD, that is, $563 \text{ kgSS/d} \times 0.5 \text{ kgBOD/kgSS} = 282 \text{ kgBOD/d}$). Hence, the BOD load from the aerobic sludge returned to the UASB reactor is $(282 \text{ kg/d})/(3,350 \text{ kg/d}) = 8\%$ of the BOD load in the influent. This increased load should not affect significantly the performance of the UASB reactor.

(e) Oxygen consumption and required power for the aerators

The average O_2 consumption for the carbonaceous demand (oxidation of BOD) is $0.87 \text{ kgO}_2/\text{kgBOD}$ removed in the aeration tank (see Table 38.1 or Table 31.6). The BOD load removed in the activated sludge system is 903 kgBOD/d (calculated in item (d)). The O_2 consumption is:

$$\begin{aligned} \text{Average } \text{O}_2 \text{ consumption (carbonaceous demand)} \\ = 0.87 \text{ kgO}_2/\text{kgBOD} \times 903 \text{ kgBOD/d} = 786 \text{ kgO}_2/\text{d} \end{aligned}$$

The average O_2 consumption adopted for the nitrogenous demand (oxidation of the ammonia) is $4.6 \text{ kgO}_2/\text{kg N}$ available (see Table 38.1). The TKN load available corresponds to the applied load minus the N load incorporated into the excess sludge (10% of the VSS production). In this example, the VSS load produced was calculated as 452 kgVSS/d . The N load available is:

$$\begin{aligned} \text{N load available} &= \text{N load applied} - \text{N load excess sludge} \\ &= 446 - 0.1 \times 452 = 401 \text{ kgN/d} \end{aligned}$$

The O_2 consumption for the nitrogenous demand is:

$$\begin{aligned} \text{Average } \text{O}_2 \text{ consumption (nitrogenous demand)} \\ = 4.6 \text{ kgO}_2/\text{kgTKN} \times 401 \text{ kgTKN/d} = 1,845 \text{ kgO}_2/\text{d} \end{aligned}$$

This value corresponds to $(1,845 \text{ kgO}_2/\text{d})/(446 \text{ TKN applied}) = 4.1 \text{ kgO}_2/\text{kgTKN}$ applied (matches with value in Table 38.1).

The *total* average consumption is:

$$\begin{aligned} \text{Total average } \text{O}_2 \text{ consumption} &= \text{carbonaceous demand} + \text{nitrogenous demand} \\ &= 786 + 1,845 = \mathbf{2,631 \text{ kgO}_2/\text{d}} \end{aligned}$$

It can be observed that, differently from the conventional activated sludge system, the oxygen consumption in this case is controlled by the nitrogenous demand ($1,845/2,631 = 70\%$ of the total), as most of the BOD was previously removed in the UASB reactor.

The oxygen consumption necessary to meet the demand in peak conditions is a function of the ratio between the maximum O_2 consumption and the average O_2 consumption. In this example, a value of 1.3 was adopted, considering the presence

of the UASB reactor upstream and the fact that the plant is of medium size (see Table 38.1):

$$\begin{aligned} \text{Maximum O}_2 \text{ consumption} &= (\text{maximum consumption/average} \\ &\text{consumption ratio}) \times \text{average consumption} = 1.3 \times 2,631 \text{ kgO}_2/\text{d} \\ &= \mathbf{3,420 \text{ kgO}_2/\text{d}} \end{aligned}$$

This oxygen consumption is the field demand (actual consumption in the treatment plant). The production of oxygen to be specified for standard conditions (clean water, 20 °C, sea level) is greater, so that, in the field, the reduced value of the oxygen production equals the field oxygen demand. The standard/field oxygenation efficiency correction factor adopted is 1.6 (see Table 38.1). The required O₂ in standard conditions is:

$$\begin{aligned} \text{O}_2 \text{ required in standard conditions} &= (\text{standard/field oxygenation} \\ &\text{efficiency ratio}) \times \text{field O}_2 \text{ consumption} = 1.6 \times 3,420 \text{ kgO}_2/\text{d} \\ &= \mathbf{5,472 \text{ kgO}_2/\text{d}} = 228 \text{ kgO}_2/\text{hour} \end{aligned}$$

By adopting a standard oxygenation efficiency of 1.8 kgO₂/kW·hour (see Table 38.1), the power requirement is:

$$\begin{aligned} \text{Required power} &= \text{O}_2 \text{ consumption/oxygenation efficiency} \\ &= (228 \text{ kgO}_2/\text{hour})/(1.8 \text{ kgO}_2/\text{kW}\cdot\text{hour}) = 127 \text{ kW} = 173 \text{ HP} \end{aligned}$$

As there are two aeration tanks, and the length/breadth ratio in each one is 3, **three** aerators can be adopted in each tank, making up a total of **six aerators**. The power of each aerator is:

$$\begin{aligned} \text{Power required for each aerator} &= \text{total power} / \text{number of aerators} \\ &= 173 \text{ HP}/6 = 29 \text{ HP} . \end{aligned}$$

A commercial value higher than that required should be adopted for the installed power, so that the oxygenation capacity is sufficient when there is a by-pass of the raw sewage to the UASB reactor (supply of organic carbon to the aerobic reactor, if applicable). In this example, **40 HP** aerators should be used.

$$\text{The total installed power is: } 40 \text{ HP} \times 6 = \mathbf{240 \text{ HP}} = \mathbf{176 \text{ kW}}$$

The per capita installed power is 176,000 W / 67,000 inhabitants = 2.63 W/inhabitant (appropriate, according to Table 30.3).

If aeration is controlled by switching on/off the aerators, by changing the submergence of the aerators, or by other methods, and taking into account that the by-pass of the raw sewage will be only occasional, the average *consumed* power

will be lower than the installed power. The calculation of the average consumption should be based on the ratio between the maximum and average consumptions. However, the ratio between maximum O₂ consumption/average O₂ consumption adopted (1.3) is not high, in view of the smoothing provided by the UASB reactor. It may be difficult to make the production of oxygen equal to the average consumption throughout the day (this practice would be easier if the ratio between maximum and average consumption were larger, such as in the conventional activated sludge system). Therefore, adopt, in this example, the consumed power as equal to the required power, which is calculated according to the maximum O₂ consumption:

Consumed power = 127 kW × 24 hours/d × 365 d/year = **1,112,520 kW·hour/year** (18 kW·hour/inhabitant·year, appropriate, according to Table 30.3).

The average power level, a parameter that expresses the mixing capacity of the aerators, is calculated as:

Power level = average power/reactor volume = (127,000 W)/(1,995 m³) = 64 W/m³ (sufficient to maintain the sludge in suspension).

(f) Design of the secondary sedimentation tank

Design parameters adopted (see Table 38.1):

- Hydraulic Loading Rate: HLR = 30 m³/m²·d
- Solids Loading Rate: SLR = 120 kgSS/m²·d

The required surface area, according to the concept of the hydraulic loading rate (HLR adopted = 30 m³/m²·d), is:

$$\text{Area} = Q/\text{HLR} = (9,820 \text{ m}^3/\text{d})/(30 \text{ m}^3/\text{m}^2 \cdot \text{d}) = 327 \text{ m}^2$$

The required surface area, according to the concept of the solids loading rate, depends on the load of influent solids to the sedimentation tanks. For the calculation of the solids load, the sludge return flow is $Q_r = R \times Q$. In item (d) of the example, the recirculation ratio R adopted was ($=Q_r/Q$) 0.8. Therefore, the sludge return flow is $Q_r = 0.8 \times 9,820 \text{ m}^3/\text{d} = 7,856 \text{ m}^3/\text{d}$. The MLSS concentration, calculated in item (c), is 2,000 mg/L = 2,000 g/m³ = 2.0 kg/m³. For the solids loading rate of 120 kgSS/m²·d, the required surface area is:

$$\begin{aligned} \text{Area} &= \text{SS load}/\text{SLR} = (Q + Q_r) \times \text{MLSS} / \text{SLR} \\ &= [(9,820 + 7,856) \text{ m}^3/\text{d} \times 2.0 \text{ kgSS}/\text{m}^3]/(120 \text{ kgSS}/\text{m}^2 \cdot \text{d}) = 295 \text{ m}^2 \end{aligned}$$

In this case, HLR was more restrictive, because the concentration of SS in the aeration tank is low, which results in low solids loads to the sedimentation tank. Adopt the highest value between the two calculated values (327 m² and 295 m²), that is, **327 m²**.

By adopting two sedimentation tanks, the surface area of each one is: 327 m²/2 = 164 m².

By adopting circular sedimentation tanks, the diameter of each sedimentation tank is:

$$\text{Diameter} = (\text{Area} \times 4/\pi)^{1/2} = (164 \text{ m}^2 \times 4/3.14)^{0.5} = \mathbf{14.5 \text{ m}}$$

By adopting a sidewater depth $H = 3.5 \text{ m}$, the total volume of the sedimentation tanks is $3.5 \text{ m} \times 327 \text{ m}^2 = \mathbf{1,145 \text{ m}^3}$.

The slope of the bottom of the sedimentation tanks depends on the type of sludge removal device: scrapers require a slope of approximately 1:12 (vertical/horizontal), while suction removers are suitable for a flat bottom. Dortmund-type sedimentation tanks have a much higher slope and a lower sidewater depth. If there is slope, the volume of the conical part can be included in the calculation of the total volume.

The hydraulic detention time in the secondary sedimentation tanks is:

$$\text{HDT} = V/Q = (1,145 \text{ m}^3)/(9,820 \text{ m}^3/\text{d}) = 0.12 \text{ d} = \mathbf{2.9 \text{ hours}}$$

(g) Sludge processing

According to item (d), the load of aerobic sludge generated in the activated sludge system and returned to the UASB reactor is:

Aerobic sludge, before digestion in the UASB reactor:

- Volatile solids: $P_{XV} = 422 \text{ kgVSS/d}$
- Fixed solids: $P_{XF} = 141 \text{ kgFSS/d}$
- Total solids: $P_X = 563 \text{ kgSS/d}$

Assuming a removal of 35% of VSS from the aerobic sludge during digestion in the UASB reactor (Table 38.1: values between 25 and 45%), and knowing that the load of fixed solids remains unchanged, the load of aerobic sludge wasted from the UASB reactor is:

Aerobic sludge, after digestion in the UASB reactor:

- Volatile solids: $P_{XV} = 422 \text{ kgVSS/d} \times (1-0.35) = 274 \text{ kgVSS/d}$
- Fixed solids: $P_{XF} = 141 \text{ kgFSS/d}$
- Total solids: $P_X = 274 + 141 = \mathbf{415 \text{ kgSS/d}}$

The sludge to be removed from the UASB reactor also includes the anaerobic sludge, which is usually produced in the UASB reactor. The production of anaerobic sludge is between 0.40 and 0.50 kgSS/kgBOD *removed* in the UASB reactor, or between 0.28 and 0.36 kgSS/kgBOD *applied* to the UASB reactor (see Table 38.1). By adopting a coefficient of anaerobic sludge production of 0.30 kgSS/kgBOD *applied* to the UASB reactor, the production of anaerobic sludge is:

Anaerobic sludge:

$$\begin{aligned} \text{Total solids: } P_X &= \text{coefficient of sludge production} \times \text{load of BOD} \\ \text{in the raw sewage} &= 0.30 \text{ kgSS/kgBOD} \times 3,350 \text{ kgBOD/d} = \mathbf{1,005 \text{ kgSS/d}} \end{aligned}$$

The total amount of sludge to be wasted from the UASB reactor (digested anaerobic sludge + digested aerobic sludge) is:

$$\begin{aligned}\text{Total production of sludge} &= \text{anaerobic sludge} + \text{aerobic sludge} \\ &= 1,005 + 415 = \mathbf{1,420 \text{ kgSS/d}}\end{aligned}$$

The per capita sludge production, expressed as dry solids, is: $1,420 \text{ kgSS/d} / 67,000 \text{ inhabitants} = 0.021 \text{ kgSS/inhabitant-d} = 21 \text{ gSS/inhabitant-d}$ (matches with Tables 38.1 and 30.3)

Assuming a concentration of SS of **3.0%** in the sludge removed from the UASB reactor (see Table 38.1), which is equivalent to approximately $30,000 \text{ mgSS/L}$ or 30 kgSS/m^3 , the flow of sludge removed from the UASB reactor and directed to the sludge processing is:

$$\begin{aligned}Q_{\text{ex UASB}} &= \text{load/concentration} = (1,420 \text{ kgSS/d}) / (30 \text{ kgSS/m}^3) \\ &= \mathbf{47 \text{ m}^3/\text{d}} \text{ (} 0.76 \text{ L / inhabitant} \cdot \text{d, -matches with Table 38.1)}\end{aligned}$$

The sludge removed from the UASB reactor is usually already digested and thickened, requiring just a dewatering stage. Assuming, for simplicity, a solids capture efficiency of 100% in the dewatering and a density of 1.0 for the dewatered sludge, and adopting a solids content of **25%** (approximately $250,000 \text{ mgSS/L} = 250,000 \text{ gSS/m}^3 = 250 \text{ kgSS/m}^3$) for the dewatered sludge (mechanical dewatering, see Table 38.1), the characteristics of the sludge for final disposal are:

Sludge to be disposed of (cake):

- Load of solids = **1,420 kgSS/d** (equal to the influent load to dewatering)
- Daily volume = $\text{load/concentration} = (1,420 \text{ kgSS/d}) / (250 \text{ kgSS/m}^3) = \mathbf{5.7 \text{ m}^3/\text{d}}$

The per capita production of sludge to be disposed of is:

- Per capita load of SS = $1,420 \text{ kgSS/d} / 67,000 \text{ inhabitants} = 0.021 \text{ kgSS/inhabitant-d} = 21 \text{ gSS/inhabitant-d}$ (matches with Tables 38.1 and 30.3)
- Per capita volume of sludge = $5.7 \text{ m}^3/\text{d} / 67,000 \text{ inhabitants} = 5,700 \text{ L/d} / 67,000 \text{ inhabitants} = 0.09 \text{ L sludge/inhabitant-d}$ (matches with Tables 38.1 and 30.3)

(h) Comparison with the conventional and extended aeration activated sludge systems

Chapter 34 presents a full design example of a conventional activated sludge, using the same input data. Example 31.11 presents a simplified design of an extended aeration system, also using the same input data. For the sake of comparison, the main values resulting from the three designs are listed below.

Item	Conventional activated sludge	Extended aeration	Activated sludge after UASB reactor
Sludge age (d)	6	25	8
Volume of aeration tank (m ³)	2,051	6,366	1,995
Volume of secondary sedimentation tanks (m ³)	2,128	4,416	1,145
Production of sludge to be treated (kgSS/d)	1,659 (*)	3,119 (**)	1,420 (***)
Installed power for aeration (HP)	400	600	240

(*) Add production of primary sludge. Treatment of mixed sludge by thickening, digestion and dewatering

(**) Treatment of the aerobic sludge by thickening and dewatering

(***) Aerobic and anaerobic sludge after digestion in the UASB reactor. Treatment by dewatering

Therefore, the wide range of advantages of the combined UASB reactor-activated sludge system is noticed, mainly in terms of sludge production and power consumption. In terms of unit volumes, the volume of the UASB reactor should still be added to this alternative, while the volumes of the units associated with the sludge treatment should be added to the other alternatives. The total volume of all the units in the UASB-activated sludge alternative is still a little smaller than the total volume from the other two alternatives.

Biological selectors

39.1 INTRODUCTION

The successful operation of an activated sludge plant depends on an efficient solids-liquid separation in the secondary sedimentation tank, with the following main objectives (a) produce a clarified effluent and (b) thicken the sludge on the bottom of the sedimentation tank to a satisfactory concentration for its recirculation to the reactor.

Both functions can be harmed in case the sludge presents poor settleability and thickening capacity. There are several types of deterioration of the sludge characteristics, but the most frequent one is **sludge bulking**, which is caused by an imbalance between the populations of microorganisms that make up the activated sludge floc. In a simplified manner, the floc consists of:

- *Floc-forming bacteria*. These bacteria have a gelatinous matrix, which facilitates the gathering of new microorganisms, producing a floc of larger dimensions and, as a consequence, with a higher settling velocity.
- *Filamentous bacteria*. These bacteria, which have a predominantly elongated morphology, are responsible for the floc structure, when present in a suitable number.

The balance between the filamentous and the floc-forming organisms is delicate, and a good part of the operational success of the activated sludge plant depends on it. Three conditions can occur (Horan, 1990) (see Figure 39.1).

- *Balance between filamentous and floc-forming organisms*. Good settling and thickening capacity of the sludge.

**INFLUENCE OF THE FILAMENTOUS ORGANISMS
ON THE FLOC STRUCTURE**

IDEAL, NON-BULKING FLOC

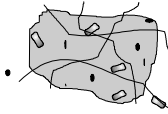

1. Filamentous and floc-forming organisms in equilibrium
2. Strong and large floc
3. Filaments do not interfere
4. Clear supernatant
5. Low SVI

PIN-POINT FLOC



1. Few or no filamentous organisms
2. Weak and small floc
3. Turbid supernatant
4. Low SVI

BULKING SLUDGE

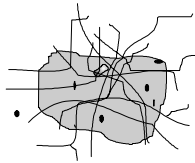

1. Filamentous organisms prevail
2. Large and strong floc
3. Filaments interfere with settling and thickening
4. Clear supernatant
5. High SVI

Figure 39.1. Effect of the filamentous organisms on the structure of the activated sludge floc (EPA, 1987)

- *Predominance of floc-forming organisms.* The floc is insufficiently rigid, which generates a small, weak floc, with poor settleability. This condition is named *pin-point floc*.
- *Predominance of filamentous organisms.* The filaments are projected outside the floc, preventing the adherence of other flocs. Thus, after sedimentation, the flocs occupy a large volume (represented by a high value of the SVI – Sludge Volume Index), which causes an increased level of the sludge blanket in the secondary sedimentation tank. This increase can lead to loss of solids, causing the deterioration of the quality of the final effluent. This condition is named *sludge bulking*.

There are several possible causes for sludge bulking, all of them associated with the environmental conditions to which the bacteria are submitted. Among them, the following can be mentioned:

- low dissolved oxygen (DO)
- low F/M ratio
- septic influent wastewater
- nutrient deficiency
- low pH

Until recently, this phenomenon was controlled only at the operational level, such as with manipulation of the return sludge flow, supply of the necessary amount of oxygen, addition of chemical products and chlorination. However, the recent progresses in the understanding of the dynamics of microbial populations in the reactor has allowed, in the design stage, the incorporation of preventive measures against sludge bulking.

The essence of this mechanism lies in the creation of environmental conditions that favour the predominance of floc-forming bacteria over filamentous bacteria. The most desirable microorganisms in the reactor are then selected by the incorporation of special reactors, named **selectors**, in the design of the biological reactor.

The subject of biological selectors is very broad and complex. Many researches are being carried out worldwide, and a substantial progress is being made in the understanding of the phenomenon. This chapter intends just to give an introductory view on the subject. Further details can be obtained in specific books on the theme, such as Jenkins *et al.* (1993) and Wanner (1994), besides recent technical papers.

Chapter 41 presents several possible forms of controlling sludge-bulking problem in existing wastewater treatment plants.

39.2 TYPES OF SELECTORS

39.2.1 Classification concerning the physical configuration

In terms of configuration of the selectors, there are basically the following types (see Figure 39.2):

- *plug-flow reactors*
- *separate, sequential compartments in plug-flow reactors*
- *separate selector tanks upstream of complete-mix reactors*

The three types are based on the principle that a *high F/M ratio favours the predominance of floc-forming organisms*. This is due to the fact that, in the zone of large food availability (high F/M), the floc-forming bacteria have better conditions to assimilate the high load of substrate than the filamentous bacteria (Metcalf and Eddy, 1991).

In *plug-flow reactors* (Fig. 39.2.a), the inlet end of the reactor has a high F/M ratio, due to the higher BOD concentrations caused by the entrance of the influent wastewater. In fact, studies in several activated sludge plants with plug-flow reactors have indicated a better sludge settleability and lower SVI values than in plants with complete-mix reactors (WRC, 1990). A plug-flow reactor is predominantly longitudinal, either by means of a long, unidirectional tank, or by means of a tank with several U or baffle walls (see Figure 36.4 of a U-shaped reactor). The U-shape, which is also frequently used in biological nutrient removal plants, enables the allocation of a reactor approaching plug flow in a not predominantly longitudinal area. Besides that, the length of some piping can be reduced, especially that of the internal recirculation line.

PHYSICAL CONFIGURATIONS OF SELECTORS

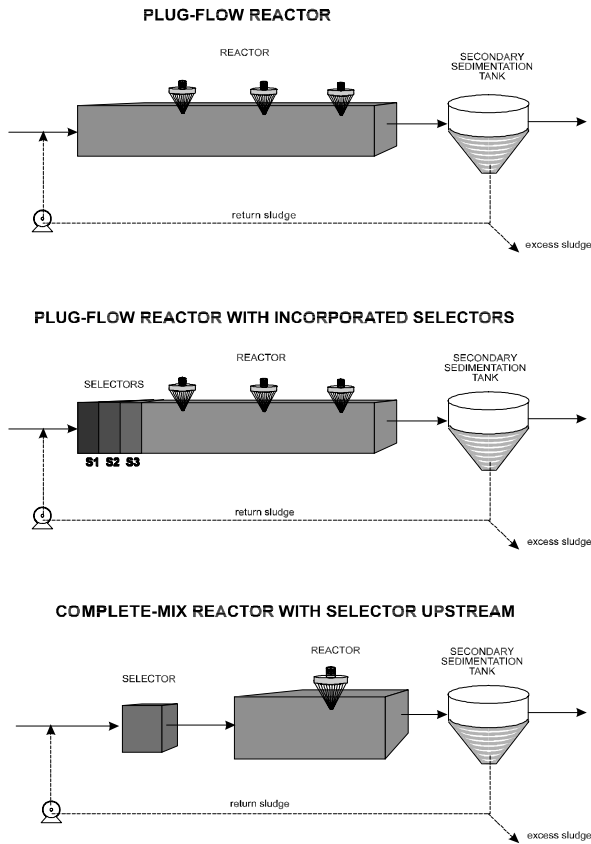

Figure 39.2. Types of configurations of biological selectors

In plug-flow reactors, the initial part can be divided into *compartments* by dividing walls, creating one or more selectors physically separated from the main part of the reactor (Figure 39.2.b). Each of these compartments has a high F/M ratio, a small volume, and a short detention time.

In the case of *complete-mix reactors*, the selector should comprise a separate tank (Figure 39.2.c), also with a high F/M ratio and a short detention time. A complete-mix reactor is predominantly square or not very elongated in plan.

The design of a plug-flow reactor can still incorporate an additional flexibility relating to the influent addition point. If the influent is distributed at several points along the tank, the system is named **step feeding**. This configuration is also used for the control of solids in the system (Keinath, 1981; EPA, 1987; Copp *et al.*, 2002). When the secondary sedimentation tank can no longer accommodate the

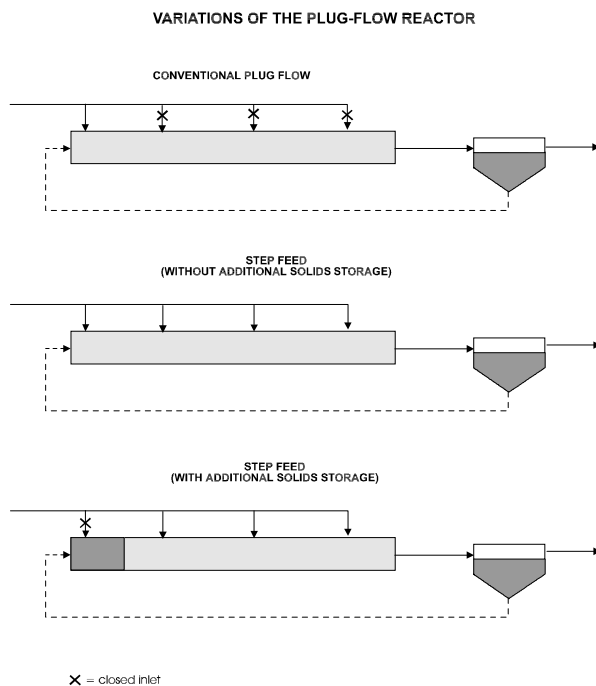

Figure 39.3. Variations of the plug-flow reactor. Conventional reactor and step feeding

solids, and the sludge blanket begins to rise (due, for instance, to sludge bulking), the solids can be temporarily stored at the entrance of the reactor, provided that the influent is diverted further downstream (Figure 39.3). This constitutes a measure to control the *effect* of the bulking, and not its *cause*. However, it is effective, being an additional resource available for the operator in the important aspect of the control of solids.

See Chapter 8 for a detailed analysis of the different reactor types and Section 32.3 for a specific analysis of activated-sludge reactors.

39.2.2 Classification concerning the availability of oxygen

Regarding the presence or absence of oxygen, the selectors can be of either one of the three types below:

- *aerobic*
- *anoxic*
- *anaerobic*

The purpose of having different types of selectors is that, by recognising the different environmental requirements of the several organisms, it is possible to create environmental conditions that favour the growth of selected organisms.

Table 39.1. Comparison between the selector types

Type of selector	Advantage	Disadvantage
<i>Aerobic</i>	<ul style="list-style-type: none"> • Simple process • Does not need internal recirculations, besides the sludge return • Depends on the tank geometry, and not on nitrification 	<ul style="list-style-type: none"> • Does not reduce the oxygen requirements • Requires a complex aeration system to supply the maximum oxygen demand in the initial zone of high F/M ratio
<i>Anoxic</i>	<ul style="list-style-type: none"> • Allows savings in the oxygen requirements • Allows savings in alkalinity consumption (increases the resistance to pH reduction) • Reduces the denitrification possibilities in the secondary sedimentation tank and the occurrence of rising sludge • The initial zone of high F/M ratio occurs in the anoxic zone (the high oxygen demand is supplied by nitrate, instead of oxygen) 	<ul style="list-style-type: none"> • Cannot be used in a non-nitrifying process • Requires an additional internal recirculation line • Requires care in the design and operation, to reduce the introduction of oxygen into the anoxic zone • A poor design can cause sludge bulking due to low DO levels • Operational problems can generate bad odours
<i>Anaerobic</i>	<ul style="list-style-type: none"> • Simple design • Does not need internal recirculations, besides the sludge return • Selector of simpler operation • Can be used for biological phosphorus removal 	<ul style="list-style-type: none"> • Does not reduce the oxygen requirements • It may not be compatible with high sludge ages • Requires care in the design and operation, to reduce the introduction of oxygen into the anaerobic zone • A poor design can cause sludge bulking due to low DO levels

Source: partly adapted from WEF/ASCE (1992)

The design of the selector-reactor system should be compatible with a broader view of the treatment plant as a whole. Aspects to be taken into consideration include (a) the nitrification capacity of the system (function of the sludge age) and (b) the desirability to encourage the denitrification in the reactor (function of the reactor configuration and of the recirculations). It is interesting that the selector is provided with an additional flexibility, allowing it to work as either anoxic or aerobic (Sampaio and Vilela, 1993)

The anoxic and anaerobic zones should be provided with *stirrers*, to ensure that the biomass remains in suspension. In the aerobic zones, there should be either mechanical or diffused air aeration.

Table 39.1 presents a balance between the advantages and disadvantages of the three types of selectors, related to the availability of oxygen.

Process control

40.1 INTRODUCTION

The main purposes of the implementation of operational control in a wastewater treatment plant can be (Andrews, 1972, 1974; Lumbers, 1982; Markantonatos, 1988; von Sperling and Lumbers, 1988; Olsson, 1989, von Sperling, 1990):

- produce a final effluent with a quality that complies with the discharge standards
- reduce the variability of the effluent quality
- avoid large process failures
- reduce operational costs
- increase the treatment capacity without physical expansion of the system
- implement an operation with variable efficiency to accommodate seasonal variations
- reduce labour requirements
- allow faster start-up

Being highly variable, the influent loads to a sewage treatment plant represent an incentive for the adoption of operational control but, at the same time, they introduce a great difficulty in its implementation. The control of a sewage treatment plant differs from the control of an industrial process, mainly regarding the great variability in the characteristics of the influent. In industrial processes, where control techniques have been traditionally used, the characteristics of the influent are deterministic, or have minor variations around the reference value,

being usually directly controllable. An additional complexity of biological treatment systems results from its own dynamics, which contains (a) non-linearities, (b) very wide ranges of time constants, (c) a heterogeneous culture of microorganisms metabolising a heterogeneous substrate, (d) inaccuracy and (e) stability interrupted by abrupt failures (Beck, 1986).

In terms of automated operational control, additional difficulties that have reduced its application in a broader way have been (Lumbers, 1982; Beck, 1986; Markantonatos, 1988; von Sperling, 1990):

- the characteristics of the influent are of a dynamic, stochastic nature, with unknown disturbances and measurement noises superposed to variations in the process
- the effect of the control actions varies for the different process variables, in terms of time lag and magnitude of the response
- there is a lack of reliable on-line sensors for some process variables
- not all the process variables can be directly measured
- the control actions are usually limited by the physical restrictions of the system
- in several plants, the possibility of control is limited due to a design with little flexibility
- there are difficulties in incorporating complex process models in the control algorithms and, conversely, there are limitations in the control strategies based on very simple process models

However, several of these problems have been recently reduced by the development of more robust sensors, cheaper and more accessible information technology, more reliable mathematical models, new control algorithms, and designs that are more flexible and adaptable to automated strategies. The automated, advanced control of real-scale activated sludge plants is covered in several IWA publications and scientific and technical reports (e.g., Copp *et al.*, 2002), von Sperling (1989a, 1990, 1992, 1994d), von Sperling and Lumbers (1988, 1991a, 1991b) and Olsson and Newell (1999)).

Because the advanced control algorithms depend on dynamic models of the system, which are not covered in this book, they are not dealt with in this chapter. The objective of the chapter is to provide the control principles of the activated sludge process, without going into detail into the control algorithms and the principles of control engineering. Therefore, this text presents only the classical or conventional control strategies.

Special attention is given in this chapter to two process variables: dissolved oxygen (DO) and mixed liquor suspended solids (MLSS). These two variables play an important role in the efficiency and in the operational costs of the activated sludge plants, as it has been already described in several sections of this book.

The last section in this chapter covers the important topic of monitoring, which is an essential requirement for process control and the evaluation of the performance of the plant.

40.2 BASIC CONCEPTS OF PROCESS CONTROL

40.2.1 Variables involved

Some basic concepts of control engineering applied to wastewater treatment plants are briefly described here. The operational control of a treatment plant can be classified according to the degree of automation, as follows (Andrews, 1972):

- manual operation, with (a) evaluation of the performance by human senses and (b) manual process control
- manual operation, with (a) performance evaluation by analyses or indicating or recording instruments and (b) manual process control
- automatic control, with (a) evaluation of the performance by automated sensors and (b) automated process control

In this chapter, emphasis is given to the second operational form, which is more frequently practised in developing regions.

In a control system, an important step is the identification of the variables involved in the process. Four types can be distinguished (von Sperling and Lumbers, 1988; von Sperling, 1990) (see Figure 40.1):

- input variables
- control variables (state variables and/or output variables)
- measured variables (input variables and/or control variables)
- manipulated variables

The *input variables* are those that force the system (forcing functions) and that cannot be directly controlled in most of the treatment plants. Examples are the influent characteristics, such as flow, BOD, SS and TKN.

The *control variables* are those that need to be controlled. They include the *state variables*, such as MLSS, DO and the sludge blanket level. A particular case

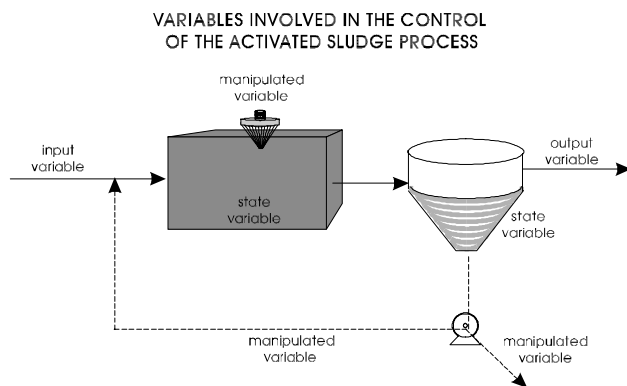

Figure 40.1. Variables involved in the control of the activated sludge process

is represented by the *output variables*, which define the effluent quality, such as effluent BOD, SS and N.

The *measured variables* are the input, control or other variables, which provide information for the definition of the control action. The selection of the variables depends on the control algorithm and on the suitability for either direct or on-line measurement.

The *manipulated variables* are those that are altered to maintain the control variables at the desired level, as determined by the control algorithm. The activated sludge process is relatively poor in terms of availability of manipulated variables, compared with industrial production lines, but it is one of the most flexible processes in comparison with other wastewater treatment processes. The main manipulated variables in the activated sludge systems are:

- aeration level (oxygen transfer coefficient – $K_L a$)
- return sludge flow (Q_r)
- excess sludge flow (Q_{ex})

Other manipulated variables can be the influent flow (if there are equalisation tanks), storage of the return sludge (requiring an additional tank), and variation of the inlet point in step-feed reactors. As they are more specific, these control forms are not covered in this chapter.

40.2.2 Control algorithms

There are several algorithms in the control-engineering field that can be used for activated sludge systems. The most common ones are the *feedback* and the *feedforward* controls.

The *feedback control* measures the output variable and takes a corrective action based on the deviation with relation to the set point. A common example is the control of DO, which is measured at each pre-established time interval, either increasing or decreasing the $K_L a$ (manipulated variable) according to the comparison between the current and the desired concentration. To guarantee a quick response, the dynamics of the control variable should be fast, as it is the case with DO, in which the variations occur in a relatively short time. This is due to the fast oxygen consumption by the microorganisms and to the fast oxygen transfer by the aerators. In the *feedback control*, it is not necessary to know and model the system, since the actions are based on deviations that have already occurred.

The other control algorithm is the *feedforward*, in which the corrective actions are based on measurements of the input variables. By means of a dynamic model of the system, the control variables and the deviations from the set point are estimated, finally leading to the adjustment of the manipulated variables. An example is the control of MLSS by the manipulation of the excess sludge flow (Q_{ex}). As the response of the system to variations in Q_{ex} is slow, the use of a *feedback* controller would not be adequate, and a *feedforward* process could be applied. In fact, several changes in activated sludge are slow, especially those based on biochemical reactions. In contrast to the *feedback* control, in *feedforward* control, a

considerable knowledge of the process is necessary, so that the output variables can be estimated. Unfortunately, this is not the case with wastewater treatment systems, and the incorporation of a significant portion of *feedback* control is frequently necessary (Andrews, 1974). This statement, made in 1974, remains true until today, in spite of the deeper knowledge of the process acquired in the past years.

Other control approaches that can be adopted are (a) optimal control and (b) control by expert systems and variants. The *optimal control* implies the existence of an objective function (e.g., cost or performance) to be optimised (either minimised or maximised) by using appropriate mathematical techniques. Constraints are established to the variables, to conform them to the physical limitations of the system and also to specified criteria, such as those related to performance or cost. The values of the manipulated variables are determined by an optimisation algorithm (von Sperling, 1990; von Sperling and Lumbers, 1991a, 1992).

The *expert systems*, a branch of artificial intelligence, incorporate the knowledge of experts, and apply this knowledge to solve problems for the users, whose capacity to interpret information and to take control decisions is not the same as that of an expert (Berthouex *et al.*, 1989). The expert systems can be used for process control or for diagnosis and correction of process failures (von Sperling, 1990; von Sperling and Lumbers, 1991b).

40.3 DISSOLVED OXYGEN CONTROL

Due to the diurnal variations of the influent BOD and ammonia loads, the oxygen demand varies with time following a certain diurnal pattern and also incorporating unpredictable or random components. If oxygen is supplied at a constant rate, equal to the average oxygen demand, there will be periods of either overaeration or underaeration during the day. To avoid this, an oxygen transfer rate corresponding to the peak demand is frequently adopted, naturally leading to overaeration periods during the day. The control of the dissolved oxygen aims at equalling the supply of oxygen to its consumption.

The methods used to regulate the aeration level vary according to the type of aeration (Flanagan *et al.*, 1977; WPCF/ASCE, 1988):

- mechanical aeration
 - switching on-off of aerators
 - variation of the rotational speed of the aerators (two speeds or variable speeds)
 - variation of the level of the aerator (variation of the submergence of the aerators by acting on the shaft)
 - variation of the water level (variation of the submergence of the aerators by adjusting the outlet weir)
- aeration by diffused air
 - variation of the speed of the blowers
 - variation of the inlet vanes

- adjustment of the suction valves of all operating blowers to maintain a constant pressure on the air feeding piping

In terms of DO control, the conventional solutions are:

- variation of $K_L a$ according to the time of the day
- variation of $K_L a$ according to the influent flow
- variation of $K_L a$ by feedback control of DO

The first method represents a simple solution, in which $K_L a$ is varied during some pre-established hours of the day (Schlegel, 1977). This is a control form that is a function of time. However, this solution assumes that the diurnal variations are the same everyday, which is improbable, especially if the influent contains a representative portion of industrial wastewaters.

The second method, which assumes the variation of $K_L a$ according to the measured influent flow, can also lead to some distortions. The first reason may result from the fact that the BOD concentration does not necessarily vary proportionally to the flow. The second reason is associated with the lag between the arrival of the BOD load and the associated oxygen consumption, due to the time necessary for the intracellular assimilation of the particulate carbonaceous material, which is not directly available like the soluble form (Cliff and Andrews, 1981b). However, both control forms represent an evolution compared with the option of no control, allowing energy savings with no need of installation of DO sensors.

The third conventional system is the *feedback* control, in which $K_L a$ varies according to the need to either increase or decrease the DO concentration in relation to the set point. As commented, the DO dynamics are fast and, consequently, suitable for *feedback* control.

An additional stage in the control of DO considers the optimum use of aeration, which involves several monitoring locations, variable set points, and manipulations in the oxygen demand itself (Lumbers, 1982). In this line, alternative or complementary approaches are:

- DO profile
- respirometry-based control – SCOUR / SNOUR (Specific Carbonaceous Oxygen Utilisation Rate / Specific Nitrogenous Oxygen Utilisation Rate)
- feedforward control
- self-adjustable control

The analysis of these advanced items is outside the scope of this text. A complementary discussion can be found in von Sperling and Lumbers (1988), von Sperling (1990) and Copp *et al.* (2002).

40.4 SOLIDS CONTROL

40.4.1 Manipulation of the variables

The main manipulated variables for the control of solids in the activated sludge process are the return sludge flow (Q_r) and the excess sludge flow (Q_{ex}). From a

practical point of view, their importance can be understood as (Takase and Miura, 1985):

- Q_{ex} controls the total SS mass in the system, and maintains it at a specified value
- Q_r controls the balance between the SS mass in the reactor and in the secondary sedimentation tanks, maintaining it at a specified ratio

The solids control methods based on Q_r and Q_{ex} are analysed separately here for an easier understanding, although both are interconnected.

(a) Return sludge flow (Q_r)

Strategies commonly used for manipulation of Q_r are (von Sperling and Lumbers, 1988):

- constant Q_r
- Q_r proportional to the influent flow Q
- Q_r function of SVI
- Q_r function of the sludge blanket level in the secondary sedimentation tanks

The return sludge flow maintained constant corresponds to a non-control strategy, which is very simple and adopted in several wastewater treatment plants. However, the return sludge flow should be large enough to accommodate the fluctuations in the solids load entering the sedimentation tanks (Lohmann and Schlegel, 1981), in terms of both flow and MLSS, especially the diurnal variations. To achieve this objective, a large flow is usually adopted, which generally recirculates more sludge than necessary.

Another very common strategy is the maintenance of Q_r proportional to Q , by adopting a fixed Q_r/Q ratio. This reduces the total quantity of sludge to be pumped (Lohmann and Schlegel, 1981) and provides a better balancing of the loads onto the sedimentation tanks.

The third method corresponds to controlling the return sludge flow by measuring the Sludge Volume Index (SVI or variants). A high value of this parameter indicates poor sludge settleability and the possible need to increase Q_r . The SVI tests are not usually performed on-line, and the manipulations are made based on the operator's experience.

The fourth method provides the largest guarantee against the loss of solids in the effluent. Its principle is the control of the return sludge flow according to the height of the sludge blanket in the secondary sedimentation tanks. Adopting Q_r as a continuous function of the sludge blanket level can present some difficulties, but either increasing or decreasing Q_r as soon as the sludge blanket level reaches a certain height is a practical solution. For example, if the blanket reaches a high specific height, the sensor located in this position detects it and sends a signal so that the sludge outlet valve in the sedimentation tanks opens more, thus increasing the sludge flow. This control can also be done manually by the operator, in a less intensive manner.

In the short term, the MLSS (X) and RASS (X_r) concentrations are ruled by purely hydraulic phenomena, and the bacterial growth reactions are irrelevant. As a result, a change in Q_r causes a rapid effect on both variables (especially RASS). If Q_r increases, X also increases, within certain limits, due to the larger solids load taken to the reactor. However, an increased Q_r usually results in a decreased X_r , which at last limits the increase in X , until the system reaches a state of equilibrium. The reverse happens if Q_r is decreased. Thus, it can be understood that the variations in MLSS due to the manipulations in Q_r are somehow limited.

(b) Excess sludge flow (Q_{ex})

Manual control of the excess sludge removal rate is practised in almost all activated sludge systems. Some commonly used strategies are:

- control of MLSS (constant MLSS)
- control of the sludge load (constant F/M ratio)
- control of the sludge age (constant θ_c)

Due to the importance of these three procedures, they are covered separately in the following section.

40.4.2 Control of process indicators

The classical methods, traditionally used for the solids control in activated sludge systems, are:

- control of MLSS (constant MLSS)
- control of the sludge load (constant F/M ratio)
- control of the sludge age (constant θ_c)

There are other methods, at an intermediate level, which are not covered in this book. They include (a) control of the Oxygen Utilisation Rate, (b) feedback control of the effluent BOD, (c) feedback control of the effluent nitrogen, (d) control of the sludge blanket level in the secondary sedimentation tank (mentioned above, but also subject to control by Q_{ex}).

(a) Control of MLSS

This is probably the strategy most commonly used by operators, though intuitively. Its purpose is to maintain MLSS constant. If an appropriate level of MLSS is maintained, a good quality of the effluent is usually expected. In terms of soluble BOD, the control of the MLSS concentration by the removal of excess sludge is equivalent to the control of the F/M ratio (Item b below) and sludge age (Item c below), under steady-state conditions. However, in the operation of a wastewater treatment plant, steady-state conditions rarely occur, and the system usually operates in the dynamic state (continuous variation of the flows and influent concentrations, causing continuous changes in the state variables).

The manipulation of the excess sludge flow is more frequently used for the control of MLSS, although the manipulation of the return sludge flow can be used

within certain limits. The response of the system to Q_{ex} variations is slow (reduced mass of solids wasted per day, compared with the existing total solids mass). Regarding Q_r , the response in the secondary sedimentation tank is fast (smaller mass of solids present in the sedimentation tank), while the response is slow in the reactor (larger mass of solids and, as a consequence, higher inertia).

The selection of the desired MLSS level is essential for a successful control. The critical aspects include:

- A constant MLSS implies a variable solids load to the sedimentation tank, since the influent flow is usually variable. Depending on the MLSS level, this variability can be harmful to the performance of the system in terms of effluent suspended solids.
- The MLSS level affects the removal of carbonaceous matter (BOD) and the nitrification and denitrification. Higher MLSS values can increase the BOD removal efficiency, but they can, in parallel, cause a higher consumption of dissolved oxygen, which can lead to a possible reduction in the DO concentration in the reactor, to the point of affecting nitrification.

(b) Control of the F/M ratio

As already seen in Section 9.5.7, the sludge load, or food/microorganism ratio (F/M), is a practical design and operational parameter. F/M represents the substrate load per unit sludge mass, according to the formula:

$$\frac{F}{M} = \frac{Q \cdot S_o}{V \cdot X_v} \quad (40.1)$$

where:

F/M = food/microorganism ratio (d^{-1})

Q = influent flow (m^3/d)

S_o = concentration of influent substrate (BOD₅ or COD) (g/m^3)

X = biomass concentration (total – MLSS, volatile – MLVSS or active) (g/m^3)

V = volume of the reactor (m^3)

The purpose of the control is usually to maintain a constant F/M ratio to ensure a uniform substrate removal. The F/M value to be adopted is usually a design data, but it is frequently adjusted by experience during the operation. The procedure to control the F/M ratio is by adjusting the solids concentration X (by manipulating Q_{ex} or Q_r) according to the influent substrate load to maintain the F/M ratio constant (see Equation 40.1).

However, some problems are related to the F/M control (von Sperling, 1992, 1994d):

- BOD₅ cannot be used in the control as substrate indicator, since laboratory results take 5 days to be obtained.

- The unit day^{-1} is usually confusing for operators.
- The F/M ratio is an essentially steady-state parameter, and its association with the quality of the effluent is not valid under dynamic conditions, which prevail in wastewater treatment plants.
- The possibilities of instantaneous control of the F/M ratio by using Q_r to change the MLSS concentration are limited, due to the large mass of solids in the reactor. The manipulation of Q_{ex} leads to effects only in the medium term, being therefore unable to absorb transients and diurnal variations of the influent BOD load.
- The F/M ratio is quantitatively related to the quality of the final effluent only in terms of soluble BOD. However, soluble BOD is usually low, especially in extended aeration systems (von Sperling and Lumbers, 1989a). The biggest problem regarding the effluent BOD is usually the particulate BOD, caused by the suspended solids in the effluent. Increased values of MLSS to maintain the F/M ratio constant can cause an overload of solids into the secondary sedimentation tank, with possible deterioration of the particulate BOD of the effluent.

(c) Control of the sludge age

Solids Retention Time (SRT), Mean Cell Residence Time (MCRT) and Sludge Age (θ_c) are designations used to express the average time the biomass remains in the system. The concept of sludge age is defined in Section 9.5.3, being widely covered in this book. Under steady-state conditions, the growth rate of the cells should be compensated by their removal via the excess sludge, to maintain the biomass concentration constant. Under these conditions, in which the biomass production is equal to its wastage, the sludge age can be defined as:

$$\begin{aligned}\theta_c &= (\text{mass of solids in the system})/(\text{mass of solids produced per day}) \\ &= (\text{mass of solids in the system})/(\text{mass of solids wasted per day})\end{aligned}\quad (40.2)$$

As commented in Section 31.15, there are two classical methods to control the sludge age, with the purpose of keeping it at a constant value:

- wastage of solids from the return sludge line (the concentration of excess sludge is equal to the concentration of the return sludge RASS)
- wastage of solids from the aeration tank or from its effluent (the concentration of the excess sludge is equal to MLSS). This method is named hydraulic control

The hydraulic control is conceptually simpler, without the need for the measurement of the solids concentration. A fraction of the volume of the reactor equal to $1/\theta_c$ should be removed daily. Thus, if a 20-day sludge age is desired, a volume equal to $1/20$ of the reactor should be discarded per day. If this fraction is removed daily, the sludge age will remain theoretically constant, independent of the influent flow. If the influent BOD load is constant, the concentration of solids will remain constant, and the θ_c control is equivalent to the control of MLSS. If the influent substrate load increases, the concentration of solids will also increase. Hence, both

the mass of solids present in the system and the mass of solids being discarded will increase proportionally, and the sludge age will remain constant.

However, these considerations are only valid in the steady state or in each hypothetical steady state of the operation, not covering the transients between one stage and another. This concept is consequently limited because, in the real operation of a plant, the transients occur more frequently than the occasional steady states. In the dynamic state, the two relations in Equation 40.2 are no longer the same, and the sludge production is different from the sludge wastage, generating either positive or negative mass accumulations in the reactor. Under the steady-state assumption, a sudden increase of substrate concentration is assumed as being immediately followed by an increase of the biomass concentration. However, the bacterial growth takes time, and a deterioration of the effluent will not be noticed until a new steady state is achieved (if it is at all achieved).

Other problems of the control by the sludge age are (von Sperling, 1992, 1994d):

- The sludge age concept comprises only the soluble substrate in the reactor, not covering the usually more important component related to the effluent particulate BOD from the system.
- The sludge age concept was mainly developed for the removal of carbonaceous matter. However, the sludge age of the nitrifying bacteria, whose growth rate is very slow, is usually different from the sludge age of the heterotrophic bacteria responsible for the BOD removal (under dynamic conditions and modifications of the environmental conditions, such as dissolved oxygen concentration). Therefore, there is no general sludge age for all bacteria.
- The control by sludge age does not take into consideration the contribution of the influent inert SS to the biological stage, which can change the balance between production (including influent) and wastage of solids.
- The control of the sludge age focus only on the reactor, and does not take into consideration the important stage of final sedimentation and its implications on the quality of the final effluent, in terms of suspended solids and particulate BOD.

(d) Discussion on the classical methods

A general evaluation of the classical methods leads to the following main points:

- The classical strategies do not integrate the simultaneous control of the reactor and the secondary sedimentation tank, and do not recognise the fundamental importance of the secondary sedimentation tank to the overall quality of the effluent.
- The classical strategies do not focus simultaneously on the purposes of removing the carbonaceous and nitrogenous matter.
- The classical strategies are based mainly on the separate manipulation of the return sludge and the excess sludge. Therefore, its potential for an integrated and simultaneous manipulation is not used.

- There is an inherent difficulty regarding the choice of the MLSS, θ_c or F/M value to be maintained. A certain value can be satisfactory under certain conditions, but unsatisfactory under others.
- The classical strategies are based on steady-state operating conditions, which rarely occur in real practice.

Based on the considerations mentioned above, an impression might have been created that there are no adequate strategies for the control of activated sludge systems, which are, paradoxically, the most flexible wastewater treatment process. This impression should not be true, and the point discussed herein is that an integrated management should be adopted, instead of the usual approach to control the system according to a single variable only. Even a simple combination of two control variables, such as MLSS and sludge blanket level, has better chances of being successful in terms of the overall performance than each of the separate strategies.

Besides that, it is believed that a dynamic model for the reactor – secondary sedimentation tank system can be directly used to evaluate a control strategy. Even though there is still a certain reluctance by many operators in using mathematical models, it should be remembered that strategies conceptually as simple as the control by sludge age or by F/M ratio have as a support a model (although simplified) of the kinetics of bacterial growth and substrate removal.

The ideal approach is the adoption of a dynamic model that, even with a simplified structure, covers the reactor and the secondary sedimentation tank, and simulates the removal of carbonaceous and nitrogenous matter. The simultaneous consideration of the units and processes is considered a minimum requirement for any control strategy to be adopted. However, due to their complexity, dynamic models are not included in the scope of this book.

In summary, it is believed that the control strategies to be adopted should have the following characteristics (von Sperling, 1992, 1994d):

- Integrated control of the system, by (a) simultaneous actuation on the manipulated variables (Q_r and Q_{ex}), (b) consideration of the interactions between the reactor and the secondary sedimentation tank, (c) consideration of the simultaneous purposes of BOD, SS and ammonia (sometimes N and P) removal and (d) incorporation of the minimisation of the operational costs as some of the purposes.
- Operation not directed to the control of certain variables (e.g., MLSS, F/M or θ_c) to fixed (questionable) set points, but to the output variables (e.g., BOD, SS, ammonia), which should explicitly comply with quality standards for the effluent.
- Non-use of a single process indicator or a single variable (e.g., MLSS, F/M or θ_c), but use of an integrated dynamic model of the system, covering the reactor and the secondary sedimentation tank, and with all the important input, state and manipulated variables interacting simultaneously. The model, and not just a single variable, should be used to drive the control strategy (von Sperling, 1990).

Table 40.1. Monitoring programme for activated sludge systems (liquid phase)

Place	Parameter	Sample		
		Use	Frequency	Type
Raw sewage	BOD	PE	Weekly	composite
	COD	PE	Weekly	composite
	SS	PE	Weekly	composite
	VSS	PE	Weekly	composite
	TKN	PE	Weekly	composite
	pH	PC	Daily	simple
	Alkalinity	PC	Weekly	simple
	Coliforms	PE	Weekly	simple
Primary effluent	BOD	PE	Weekly	composite
	COD	PE	Weekly	composite
	SS	PE	Weekly	composite
Reactor	Temperature	PC	Daily	simple
	DO	PC	Daily or continuous	simple or sensor
	SS	PC	Daily or continuous	simple or sensor
	VSS	PC	Weekly	simple
	NO ₃ ⁻	PC	Weekly	simple
	SVI	PC	Daily	simple
Return sludge	SS	PC	Daily	composite
Final effluent	BOD	PE	Weekly	composite
	COD	PE	Weekly	composite
	SS	PE	Weekly	composite
	SSV	PE	Weekly	composite
	TKN	PE	Weekly	composite
	NH ₃	PE	Weekly	composite
	NO ₂ ⁻	PE	Weekly	composite
	NO ₃ ⁻	PE	Weekly	composite
	pH	PE	Daily	simple
Coliforms	PE	Weekly	simple	

PE = performance evaluation; PC = process control

Other wastewater characterisation parameters can be included, depending on the need

The programme can vary according to the size and relative importance of the plant

Source: adapted from WEF (1990)

40.5 MONITORING THE SYSTEM

Process monitoring is essential for its adequate performance. Table 40.1 proposes a programme for typical activated sludge plants, without automated process control. Naturally, depending on the size and the degree of relative importance of the treatment plant, the frequency and the number of parameters can be either increased or reduced.

41

Identification and correction of operational problems

41.1 INTRODUCTION

This chapter presents a synthesis of the main operational problems liable to occur in activated sludge systems, including their causes and control measures. Due to the large variety of problems, the list does not intend to be exhaustive and deep, but only an initial guide for the operator. The items focused refer to the increase in the concentration of the following parameters in the final effluent: (a) suspended solids, (b) BOD and (c) ammonia.

The structure of the presentation is in terms of a knowledge basis, which can be used for the development of expert systems for guiding the operator in the solution of operational problems.

The classification of the problems, their detection, causes and control forms are based on a review of several references, including Adelusi (1989), Gall and Patry (1989), WRC (1990), Kwan (1990), WEF (1990), Gray (1991), Metcalf and Eddy (1991) and Wanner (1994).

41.2 HIGH CONCENTRATIONS OF SUSPENDED SOLIDS IN THE EFFLUENT

41.2.1 Causes

- *Rising sludge*
- *Bulking sludge*
- *Pin-point floc*
- *Dispersed sludge*
- *Overload of solids in the secondary sedimentation tanks (non-bulking sludge)*
- *Hydraulic overload in the secondary sedimentation tanks*
- *Foam and scum*
- *Other operational problems of the secondary sedimentation tanks*

41.2.1.1 Rising sludge

Detection:

- Sludge clumps floating on the secondary sedimentation tank surface
- Gas bubbles entrapped in the floc
- Supernatant possibly clarified (except for the clumps); low turbidity
- Possibly high SVI
- Non-significant presence of filamentous bacteria on microscopic examination

Causes:

- Denitrification in the secondary sedimentation tank (with release of nitrogen gas bubbles)
- Gas bubbles adhered to the floc
- Septic sludge (with release of gas bubbles from anaerobic decomposition)
- Emulsified grease and oil

Detailing and correction of the causes:

(a) Denitrification in the secondary sedimentation tank

<i>Cause 1: Insufficient denitrification in the preceding units</i>	
<i>Secondary causes</i>	<ul style="list-style-type: none"> • Lack of anoxic zones in the preceding units • Insufficient anoxic zones in the preceding zones • Insufficient organic carbon in the anoxic zone • Insufficient amount of nitrified effluent in contact with the anoxic zone • pH in the anoxic zone outside the range from 6.5 to 8.0

<i>Control</i>	<ol style="list-style-type: none"> 1. Create or increase the anoxic zone in the reactor, and ensure that the denitrifying bacteria are supplied with enough organic carbon: <ul style="list-style-type: none"> • Anoxic zone downstream the aerated zone (post-denitrification) <ul style="list-style-type: none"> – Introduce/increase bypass of raw sewage to the post-anoxic zone (raw sewage as source of organic carbon) – Increase volume of the anoxic zone – If it is not possible to add raw sewage to the anoxic zone, complement the organic carbon requirements with methanol or other similar product • Anoxic zone upstream the aerated zone (pre-denitrification) <ul style="list-style-type: none"> – Introduce/increase internal recirculation from the aerated zone (nitrified liquid) to the anoxic zone – Avoid recirculation containing oxygen – Increase volume of the anoxic zone • Anoxic zones upstream and downstream the aerated zone <ul style="list-style-type: none"> – Introduce/increase internal recirculation from the aerated zone (nitrified liquid) to the anoxic zone – Avoid recirculation containing oxygen – Increase volume of the anoxic zone • Simultaneous nitrification/denitrification (oxidation ditches) <ul style="list-style-type: none"> – control aeration to maintain a balance between the aerobic/anoxic zones (nitrification/denitrification) (for pH control: see Section 41.2.1.2.b) 2. If the pH is out of range, wait a certain time, since nitrification will also be affected, thus reducing denitrification itself 3. Reseed with active denitrifying biomass
----------------	---

Cause 2: Long detention time of the sludge in the secondary sedimentation tank

<i>Secondary causes</i>	<ul style="list-style-type: none"> • Low return sludge flow • Low velocity of the sludge removal mechanism • Problems with the sludge removal mechanism
-------------------------	--

<i>Control</i>	<ol style="list-style-type: none"> 1. Reduce the sludge detention time in the secondary sedimentation tank <ul style="list-style-type: none"> • Increase the return sludge flow • Increase the velocity of the sludge scraping or collection mechanism • Repair the sludge scraping or collection mechanism, if defective • If the problem is in only one or in some tanks, reduce the influent flow to the defective tanks
----------------	---

<i>Cause 3: Undesired nitrification in the reactor, leading to denitrification in the secondary sedimentation tank</i>	
<i>Secondary cause</i>	<ul style="list-style-type: none"> • If the activated sludge system has not been designed to nitrify and denitrify (effluent ammonia is not an important item in this plant) and if nitrification is occurring, it may lead to denitrification in the secondary sedimentation tank
<i>Control</i>	<ol style="list-style-type: none"> 1. Either reduce or eliminate nitrification in the reactor <ul style="list-style-type: none"> • Reduce the DO concentration in the reactor • Reduce the sludge age by increasing the excess sludge flow

(b) Gas bubbles attached to the floc

<i>Causes</i>	<ul style="list-style-type: none"> • If diffused air is used, an excessive aeration can cause bubbles adhered to the floc • If there is a post-anoxic zone, nitrogen gas bubbles may remain adhered to the floc directed to the secondary sedimentation tank
<i>Control</i>	<ol style="list-style-type: none"> 1. Reduce the aeration level 2. Introduce a reaeration stage after the anoxic zone, to release the gas bubbles prior to the secondary sedimentation tank

(c) Septic sludge

<i>Detection</i>	<ul style="list-style-type: none"> • Odour • Analyse sewage in terms of sulphides and volatile organic acids
<i>Causes</i>	<ul style="list-style-type: none"> • Low return sludge flow • Problems with the mechanical scrapers • Presence of highly concentrated industrial wastes

<i>Control</i>	<ol style="list-style-type: none"> 1. Reduce the sludge detention time in the secondary sedimentation tank <ul style="list-style-type: none"> • Increase the return sludge flow • Increase the velocity of the sludge scraping or collection mechanism • Repair the sludge scraping or collection mechanism, if defective • If the problem is in only one or in some tanks, reduce the influent flow to the defective tanks 2. Increase the removal efficiency of the highly concentrated industrial wastes <ul style="list-style-type: none"> • Reduce the excess sludge flow to increase the MLVSS concentration • Increase the aeration level (see Section 41.2.1.2.a)
----------------	---

(d) Emulsified grease and oil

<i>Cause</i>	<ul style="list-style-type: none"> • Industrial wastes
<i>Control</i>	<ol style="list-style-type: none"> 1. Use hose jets to direct oil and grease to the scum remover 2. Verify whether the scum removal equipment in the primary and secondary sedimentation tanks are working well 3. Increase the frequency and duration of the surface scraping to assure an appropriate removal of oil and grease 4. Verify, in the primary sedimentation tank, whether the effluent baffle is deep enough to prevent oil and grease from passing underneath 5. Remove the oil and grease at the source

41.2.1.2 Bulking sludge

Detection:

- Cloudy mass in the secondary sedimentation tank
- High SVI value
- Low concentration of SS in the return sludge
- High sludge blanket level
- Clear supernatant
- Filamentous bacteria present in the microscopic examination

Causes:

- Low concentrations of DO in the reactor
- pH lower than 6.5
- Low floc load in the entrance of the reactor
- Nutrient deficiency
- Septic sewage
- Presence of large amounts of rapidly degradable carbohydrates

Control based on the causes of the problem:

(a) Low DO concentrations in the reactor

<i>Cause 1: Insufficient oxygen supply due to problems in the aeration system</i>	
• <i>Mechanical aeration</i>	
<i>Secondary causes</i>	<ul style="list-style-type: none"> • Defective aerators • Defective DO control system • Accidental switching-off of the aerators • Power failure
<i>Control</i>	<ul style="list-style-type: none"> • Repair or replace defective aerators • Lubricate bearings and motors of the aerators • Repair defective DO control system • In case of frequent power failures, install stand-by generator
• <i>Diffused-air aeration</i>	
<i>Secondary causes</i>	<ul style="list-style-type: none"> • Clogged diffusers • Dirty blowers • Defective blowers • Defective DO control system • Power failure
<i>Control</i>	<ol style="list-style-type: none"> 1. Clean clogging in the diffusers <ul style="list-style-type: none"> • Fixed porous dome diffusers: empty the tank and scrub with detergent or mild muriatic acid • Tube diffusers: remove the tubes from the tanks and replace them, allowing the aeration to continue. Clean the tube with running water, and leave it in a strong detergent solution. Rinse it, and test its permeability under pressure 2. Increase temporarily the air flow to clean clogged coarse bubble diffusers 3. Install air purification system before the air enters the diffusers

	<ol style="list-style-type: none"> 4. Use solvents to clean blowers 5. Lubricate/replace bearings when necessary 6. Repair defective DO control system 7. In case of frequent power failures, install a stand-by generator
<i>Cause 2: Insufficient oxygen supply due to inadequate control of the aeration rate (for mechanical aeration)</i>	
• <i>Manual control by switching on/off the aerators</i>	
<i>Secondary causes</i>	<ul style="list-style-type: none"> • Selection of an excessive switching-off time of the aerators • Selection of an excessive number of switched-off aerators • Incorrect selection of the switching on/off times of the aerators • Incorrect selection of the aerators to be turned off • Stepwise variation of the aeration rate, leading to periods with insufficient aeration • Insufficient submergence of the aerators
<i>Control</i>	<ol style="list-style-type: none"> 1. Reduce the duration of certain switching-off periods of the aerators 2. Reduce the number of aerators turned off 3. Change the selection of the switching-off times of the aerators 4. Change the selection of the aerators to be turned off 5. Increase submergence of the aerators
• <i>Manual control by two rotation-speed aerators</i>	
<i>Secondary causes</i>	<ul style="list-style-type: none"> • Incorrect selection of the rotation reduction times • Incorrect selection of the aerators to have their rotation reduced • Stepwise variation of the aeration rate, leading to periods with insufficient aeration • Defective rotation variation mechanism
<i>Control</i>	<ul style="list-style-type: none"> • Change the selection of the rotation reduction times • Change the selection of the aerators to have their rotation reduced • Install more aerators • Verify the rotation variation control mechanism
• <i>Switching on/off control by timer</i>	
<i>Secondary cause</i>	<ul style="list-style-type: none"> • Refer to “Manual control by switching on/off” above
<i>Control</i>	<ol style="list-style-type: none"> 1. Refer to “Manual control by switching on/off” above

<ul style="list-style-type: none"> • <i>Manual switching on/off control by continuous DO measurement and limit value alarm</i> 	
<i>Secondary causes</i>	<ul style="list-style-type: none"> • Refer to “Manual control by switching on/off” above • Incorrect switching off alarm set point • Poor operation of the DO sensor due to (a) defective instrument, (b) insufficient calibration, (c) incorrect calibration or (d) foul sensor
<i>Control</i>	<ol style="list-style-type: none"> 1. Refer to “Manual control by switching on/off” above 2. Adjust the switching off alarm set point 3. Verify the DO sensor: <ul style="list-style-type: none"> • Replace defective parts • Recalibrate • Clean sensor
<ul style="list-style-type: none"> • <i>Manual control by two rotation-speed aerators, by continuous DO measurement and limit value alarm</i> 	
<i>Secondary causes</i>	<ul style="list-style-type: none"> • Refer to “Manual control by two rotation-speed aerators” above • Incorrect switching off alarm set point • Poor operation of the DO sensor due to (a) defective instrument, (b) insufficient calibration, (c) incorrect calibration or (d) foul sensor
<i>Control</i>	<ol style="list-style-type: none"> 1. Refer to “Manual control by two rotation-speed aerators” above 2. Adjust the switching off alarm set point 3. Verify the DO sensor: <ul style="list-style-type: none"> • Replace defective parts • Recalibrate • Clean sensor
<ul style="list-style-type: none"> • <i>Automatic switching on/off control of aerators, based on continuous DO measurements</i> 	
<i>Secondary causes</i>	<ul style="list-style-type: none"> • Refer to “Manual switching on/off control by continuous DO measurement and limit value alarm” above • Excessively low “switch on” point • Excessively low “switch off” point
<i>Control</i>	<ol style="list-style-type: none"> 1. Refer to “Manual switching on/off control by continuous DO measurement and limit value alarm” above 2. Raise “switch on” point 3. Raise “switch off” point
<ul style="list-style-type: none"> • <i>Automatic control of two rotation-speed aerators, based on continuous DO measurements</i> 	
<i>Secondary causes</i>	<ul style="list-style-type: none"> • Refer to “Manual control by two rotation-speed aerators, by continuous DO measurement and limit value alarm” above

<i>Control</i>	<ol style="list-style-type: none"> 1. Refer to “Manual control by two rotation-speed aerators, by continuous DO measurement and limit value alarm” above
<ul style="list-style-type: none"> • <i>Automatic control of multiple-rotation speed aerators, based on continuous DO measurements</i> 	
<i>Secondary causes</i>	<ul style="list-style-type: none"> • Refer to “Automatic control of two rotation-speed aerators, based on continuous DO measurements” above • Low DO set point • Insufficient range for variation of the rotation speed • Inadequate relation between the aerator rotation and the DO (gains from the feedback control) • Increased rotation does not lead to increased oxygen transfer rate
<i>Control</i>	<ol style="list-style-type: none"> 1. Refer to “Automatic control of two rotation-speed aerators, based on continuous DO measurements” above 2. Raise DO set point 3. Change parameters in the relation between rotation speed and DO (gains from the feedback control) 4. Verify rotation variation mechanism and repair/replace defective parts
<ul style="list-style-type: none"> • <i>Automatic control of the aeration level by variation of the outlet weir level, based on continuous DO measurements</i> 	
<i>Secondary causes</i>	<ul style="list-style-type: none"> • Low DO set point • Insufficient weir level variation range • Inadequate relation between the weir level and the DO (gains from the feedback control) • Increased weir level does not lead to increased oxygen transfer rate • Defective weir level variation mechanism • Poor operation of the DO sensor due to (a) defective instrument, (b) insufficient calibration, (c) incorrect calibration or (d) foul sensor
<i>Control</i>	<ol style="list-style-type: none"> 1. Raise DO set point 2. Change parameters in the relation between weir level and DO (gains from the feedback control) 3. Verify weir level variation mechanism and repair/replace defective parts 4. Verify the DO sensor: <ul style="list-style-type: none"> • Replace defective parts • Recalibrate • Clean sensor

<ul style="list-style-type: none"> • <i>Automatic control of the aeration level by variation of the level of the vertical shaft of the aerator, based on continuous DO measurements</i> 	
<p><i>Secondary causes</i></p>	<ul style="list-style-type: none"> • Low DO set point • Insufficient range of variation of aerator shaft • Inadequate relation between the shaft level and the DO (gains from the feedback control) • Lowering the shaft level of the aerator not leading to increased oxygen transfer rate • Defective mechanism for variation of the shaft level • Poor operation of the DO sensor due to (a) defective instrument, (b) insufficient calibration, (c) incorrect calibration or (d) foul sensor
<p><i>Control</i></p>	<ol style="list-style-type: none"> 1. Raise DO set point 2. Change parameters in the relation between shaft level and DO (gains from the feedback control) 3. Verify mechanism for variation of shaft level, and repair/replace defective parts 4. Verify the DO sensor: <ul style="list-style-type: none"> • Replace defective parts • Recalibrate • Clean sensor
<p><i>Cause 2: Insufficient oxygen supply due to inadequate control of the aeration rate (for diffused air aeration)</i></p>	
<ul style="list-style-type: none"> • <i>Manual control by switching on/off blowers</i> 	
<p><i>Secondary causes</i></p>	<ul style="list-style-type: none"> • Selection of an excessive switching-off time of the blowers • Selection of an excessive number of blowers turned off • Incorrect selection of the switching on/off times of the blowers • Stepwise variation of the aeration rate, leading to periods with insufficient aeration
<p><i>Control</i></p>	<ol style="list-style-type: none"> 1. Reduce the duration of certain switching-off periods of the blowers 2. Reduce the number of blowers turned off 3. Change the selection of the switching-off times of the blowers
<ul style="list-style-type: none"> • <i>Manual control by variation of the opening of the inlet vanes</i> 	
<p><i>Secondary causes</i></p>	<ul style="list-style-type: none"> • Insufficient opening of the inlet vanes • Incorrect selection of the opening/closing times of the vanes
<p><i>Control</i></p>	<ol style="list-style-type: none"> 1. Open the inlet vanes more 2. Change the selection of the opening/closing times of the vanes

<ul style="list-style-type: none"> • <i>Switching on–off control of the blowers by timer</i> 	
<i>Secondary causes</i>	<ul style="list-style-type: none"> • Refer to “Manual control by switching on/off blowers” above
<i>Control</i>	<ol style="list-style-type: none"> 1. Refer to “Manual control by switching on/off blowers” above
<ul style="list-style-type: none"> • <i>Control of the variation of the opening of the inlet vanes by timer</i> 	
<i>Secondary causes</i>	<ul style="list-style-type: none"> • Refer to “Manual control of the variation of the opening of the inlet vanes” above
<i>Control</i>	<ol style="list-style-type: none"> 1. Refer to “Manual control of the variation of the opening of the inlet vanes” above
<ul style="list-style-type: none"> • <i>Manual switching on/off control of blowers by continuous DO measurement and limit value alarm</i> 	
<i>Secondary causes</i>	<ul style="list-style-type: none"> • Refer to “Manual switching on/off control of blowers” above • Incorrect switching-off alarm set point • Poor operation of the DO sensor due to (a) defective instrument, (b) insufficient calibration, (c) incorrect calibration or (d) foul sensor
<i>Control</i>	<ol style="list-style-type: none"> 1. Refer to “Manual switching on/off control of blowers” above 2. Adjust the switching-off alarm set point 3. Verify the DO sensor: <ul style="list-style-type: none"> • Replace defective parts • Recalibrate • Clean sensor
<ul style="list-style-type: none"> • <i>Manual control for opening of the inlet vanes by continuous DO measurement and limit value alarm</i> 	
<i>Secondary causes</i>	<ol style="list-style-type: none"> 1. Insufficient opening of the inlet vanes 2. Incorrect switching-off alarm set point 3. Poor operation of the DO sensor due to (a) defective instrument, (b) insufficient calibration, (c) incorrect calibration or (d) foul sensor
<i>Control</i>	<ol style="list-style-type: none"> 1. Open the inlet vanes more 2. Adjust the switching-off alarm set point 3. Verify the DO sensor: <ul style="list-style-type: none"> • Replace defective parts • Recalibrate • Clean sensor

<ul style="list-style-type: none"> • <i>Automatic control of the aeration level by switching on/off the blowers, based on continuous DO measurements</i> 	
<i>Secondary causes</i>	<ul style="list-style-type: none"> • Excessively low “switching on” point • Excessively low “switching off” point • Stepwise variation of the aeration rate, leading to periods with insufficient aeration • Poor operation of the DO sensor due to (a) defective instrument, (b) insufficient calibration, (c) incorrect calibration or (d) foul sensor
<i>Control</i>	<ol style="list-style-type: none"> 1. Raise the “switching on” point 2. Raise the “switching off” point 3. Verify the DO sensor: <ul style="list-style-type: none"> • Replace defective parts • Recalibrate • Clean sensor
<ul style="list-style-type: none"> • <i>Automatic control of the aeration level by variation of the opening of the vanes, based on continuous DO measurements</i> 	
<i>Secondary causes</i>	<ul style="list-style-type: none"> • Low DO set point • Inadequate relation between the opening of the vanes and the DO (gains from the feedback control) • Poor operation of the DO sensor due to (a) defective instrument, (b) insufficient calibration, (c) incorrect calibration or (d) foul sensor
<i>Control</i>	<ol style="list-style-type: none"> 1. Raise DO set point 2. Change parameters in the relation between opening of the vanes and DO (gains from the feedback control) 3. Verify the DO sensor: <ul style="list-style-type: none"> • Replace defective parts • Recalibrate • Clean sensor
<ul style="list-style-type: none"> • <i>Automatic control of the aeration level by variation of the rotation of the blowers, based on continuous DO measurements</i> 	
<i>Secondary causes</i>	<ul style="list-style-type: none"> • Low DO set point • Inadequate relation between rotation of the blowers and DO (gains from the feedback control) • Poor operation of the DO sensor due to (a) defective instrument, (b) insufficient calibration, (c) incorrect calibration or (d) foul sensor
<i>Control</i>	<ol style="list-style-type: none"> 1. Raise DO set point 2. Change parameters in the relation between rotation of the blowers and DO (gains from the feedback control) 3. Verify the DO sensor: <ul style="list-style-type: none"> • Replace defective parts • Recalibrate • Clean sensor

<i>Cause 3: Insufficient aeration capacity</i>	
<i>Control</i>	<ol style="list-style-type: none"> 1. Mechanical aeration: <ul style="list-style-type: none"> • Investigate the cost–benefit relation for installation of more aerators • Investigate the cost–benefit relation for a local supplementation of oxygen for peak periods 2. Diffused air aeration: <ul style="list-style-type: none"> • Investigate the cost–benefit relation for installation of more diffusers and blowers • Investigate the cost–benefit relation for a local supplementation of oxygen for peak periods
<i>Cause 4: Excessive oxygen consumption</i>	
• <i>Consumption for BOD oxidation (synthesis)</i>	
<i>Secondary causes</i>	<ul style="list-style-type: none"> • High influent BOD load • High load of solids and BOD returned from the supernatant of sludge thickeners • High load of BOD returned from the supernatant of sludge digesters
<i>Control</i>	<ol style="list-style-type: none"> 1. Regulate the influent flow <ul style="list-style-type: none"> • Use stormwater storage tanks to reduce peaks (in combined sewerage systems) • Introduce/use equalisation tanks 2. Improve the operation of the thickeners <ul style="list-style-type: none"> • Remove thickened sludge more frequently • Reverse operation from continuous to batch (or vice-versa) • Add coagulants or coagulant aids to improve sludge thickening 3. Improve the operation of the digesters <ul style="list-style-type: none"> • Prevent the entrance of excessive volumes of highly organic sludge in the digester • Prevent the entrance of toxic materials in the digesters, which can inhibit the methanogenic organisms • Ensure adequate mixing in the digesters • Suspend temporarily the removal of supernatant from the digesters 4. Return supernatant from the thickeners or digesters during periods of low influent flow

<i>• Consumption for biomass respiration (endogenous respiration)</i>	
<i>Secondary causes</i>	<ul style="list-style-type: none"> • High MLSS concentrations • Low excess sludge flow • Low frequency of removal of excess sludge • Limited thickening, digestion, dewatering, storage and disposal capacity for the sludge • High return sludge flow • High influent organic load leading to a high growth of the biomass • Problems with the excess sludge removal pumps
<i>Control</i>	<ol style="list-style-type: none"> 1. Reduce the MLSS concentration <ul style="list-style-type: none"> • Increase the excess sludge removal flow • Increase the removal frequency of the excess sludge • Analyse the need/feasibility to expand the sludge treatment units • Reduce return sludge flow • Repair/replace defective excess sludge removal pumps
<i>• Consumption for ammonia oxidation (nitrification)</i>	
<i>Secondary cause</i>	<ul style="list-style-type: none"> • High influent ammonia load
<i>Control</i>	<ol style="list-style-type: none"> 1. Regulate the influent flow <ul style="list-style-type: none"> • Use stormwater storage tanks to reduce peaks (in combined sewerage systems) • Introduce/use equalisation tanks

(b) pH concentrations in the reactor lower than 6.5

<i>Cause 1: Oxidation of the carbonaceous and nitrogenous matter</i>	
<i>Control</i>	<ol style="list-style-type: none"> 1. Temporary change in the pH <ul style="list-style-type: none"> • Add alkaline agents to increase buffer capacity in the reactor • Produce temporary anoxic zone by the intermittent switching off of aerators to encourage denitrification, whilst saving alkalinity 2. Permanent change in the pH <ul style="list-style-type: none"> • Create permanent anoxic zones to encourage denitrification, whilst saving alkalinity
<i>Cause 2: Presence of low-pH industrial wastes</i>	
<i>Control</i>	<ol style="list-style-type: none"> 1. Temporary change in the pH <ul style="list-style-type: none"> • Add alkaline agents to increase buffer capacity in the reactor • Eliminate problem at the source

	<ol style="list-style-type: none"> 2. Permanent change in the pH <ul style="list-style-type: none"> • Isolate the source of acidity, demanding some form of control of the industrial wastes (either neutralisation or separate treatment)
<i>Cause 3: Return of inadequately digested supernatant from the digesters</i>	
<i>Control</i>	<ol style="list-style-type: none"> 1. Temporary change in the pH <ul style="list-style-type: none"> • Improve the operation of the digesters • Prevent the entrance of excessive volumes of highly organic sludge in the digester • Prevent the entrance of toxic materials in the digesters, which can inhibit the methanogenic organisms • Ensure adequate mixing in the digesters • Suspend temporarily the removal of supernatant from the digesters 2. Permanent change in the pH <ul style="list-style-type: none"> • Improve the operation of the digesters (see above) • Consider heating the digesters • Expand the digesters

(c) Low floc load in the inlet end of the reactor

<i>Detection</i>	<ul style="list-style-type: none"> • Floc load = $[(\text{COD}_{\text{inf}} - \text{COD}_{\text{eff}}) \cdot Q]/(X_r \cdot Q_r)$ (mgCOD/gMLSS)
<i>Causes</i>	<ul style="list-style-type: none"> • Low load of influent BOD • High concentration of MLSS in the inlet end of the reactor
<i>Control</i>	<ol style="list-style-type: none"> 1. Reduce the return sludge flow 2. Increase the excess sludge flow 3. In step-feed reactors, concentrate the entrance of influent on the inlet end of the reactor

(d) Nutrient deficiency

<i>Detection</i>	<ul style="list-style-type: none"> • Analyse influent and determine the BOD₅: N:P ratio • Conventional activated sludge – approximate ratio: 100:5:1 • Extended aeration – approximate ratio: 200:5:1
<i>Causes</i>	<ul style="list-style-type: none"> • Presence of industrial wastes deficient in N and/or P • Activated sludge operating to remove N and/or P
<i>Control</i>	<ol style="list-style-type: none"> 1. Add nitrogen or phosphorus in immediately available forms

(e) Septicity

<i>Detection</i>	<ul style="list-style-type: none"> • Odour • Analyse the influent for sulphides or volatile organic acids • Gas bubbles on the surface of the primary sedimentation tank
<i>Causes</i>	<ul style="list-style-type: none"> • Influent with long detention time in the collection and transport system • Long periods between each sludge removal in the primary sedimentation tank • Problems with the sludge scraper of the primary sedimentation tank • Influent containing wastes with high concentration of organic matter
<i>Control</i>	<ol style="list-style-type: none"> 1. Increase the removal frequency of the sludge from primary sedimentation tanks 2. Reduce the number of primary sedimentation tanks in operation 3. Increase the velocity of the sludge scraper in the primary sedimentation tank 4. Repair defective sludge scrapers in the primary sedimentation tank 5. Reduce the influent flow to the defective primary sedimentation tanks 6. Introduce pre-aeration to the influent 7. Add oxidising agents to the sewage collection and transportation system

(f) Presence of large amounts of rapidly biodegradable carbohydrates

<i>Cause</i>	<ul style="list-style-type: none"> • Presence of industrial wastes, such as those from dairies, breweries, sugar refineries
<i>Control</i>	<ol style="list-style-type: none"> 1. Introduce biological pre-treatment upstream the activated sludge system, if the problem is permanent

Control based on the operation of the secondary sedimentation tank:

<i>Objective</i>	<ul style="list-style-type: none"> • Prevent/reduce the expansion of the sludge blanket
<i>Control</i>	<ol style="list-style-type: none"> 1. Increase the return sludge flow 2. Reduce the MLSS concentration by increasing the excess sludge flow 3. Equalise the influent flow to the secondary treatment

	<ol style="list-style-type: none"> 4. Direct the influent to the second and/or subsequent entrances in step-feed reactors 5. Store the return sludge in sludge storage tanks, if there are any
--	--

Control based on rearrangement of the reactor (if feasible):

<i>Objective</i>	<ul style="list-style-type: none"> • Configure the reactor to induce conditions for better sludge settleability
<i>Control</i>	<ol style="list-style-type: none"> 1. Introduce anoxic zones in the initial end of the reactor <ul style="list-style-type: none"> • Turn off the initial aerators intermittently, aiming at producing a temporary anoxic zone (for a short time) • Create an anoxic zone by introducing a dividing wall (without aeration, but with stirrers) 2. Induce plug-flow characteristics <ul style="list-style-type: none"> • Operate with cells in series • Introduce dividing walls in the reactor

Control based on the addition of chemical products:

<i>Objective</i>	<ul style="list-style-type: none"> • Temporarily control the filamentous organisms
<i>Precautions</i>	<ul style="list-style-type: none"> • Chemical products should be added carefully and under constant monitoring. Add the product starting with small doses, and examine the floc after a reasonable period of time. Continue increasing the dosage until the filamentous organisms start to decrease
<i>Control</i>	<ol style="list-style-type: none"> 1. Toxic compounds (selectively eliminates the filamentous organisms, due to their larger surface area; not effective if bulking is due to nutrient deficiency) <ul style="list-style-type: none"> • Add chlorine or chlorine compounds at the entrance to the reactor or in the return sludge if bulking is severe, to kill the filamentous organisms • Add hydrogen peroxide to the return sludge (decay products are not harmful) 2. Flocculation agents (to increase the strength of the flocs) <ul style="list-style-type: none"> • Add metallic salts (aluminium, iron) to the reactor • Add polymers to the effluent from the reactor (influent to the secondary sedimentation tank)

Control based on the rearrangement or expansion of the plant:

<i>Objective</i>	<ul style="list-style-type: none"> Undertake permanent physical rearrangement measures in the plant, to prevent the growth of filamentous organisms
<i>Control</i>	<ul style="list-style-type: none"> Incorporate an anoxic zone upstream the reactor Reduce dispersion in the reactor Incorporate a selector tank

41.2.1.3 Pin-point floc

Detection:

<ul style="list-style-type: none"> Small, spherical, discreet flocs The larger flocs settle easily, leaving the small flocs, which generate a turbid effluent Low SVI Non-significant presence of filamentous bacteria, under microscopic examination

Causes:

<ul style="list-style-type: none"> Insufficient number of filamentous organisms (affecting the structure of the floc, which becomes fragile) Excessive aeration Composition of the influent (unbalanced nutrients) Excessive floc load at the entrance to the reactor

Detailing and correction of the causes:

<i>Cause 1: Insufficient number of filamentous organisms</i>	
<i>Detection</i>	<ul style="list-style-type: none"> Microscopic examination
<i>Secondary cause</i>	<ul style="list-style-type: none"> High sludge age (low F/M ratio)
<i>Control</i>	1. Increase the removal of excess sludge
<i>Cause 2: Excessive aeration</i>	
<i>Detection</i>	<ul style="list-style-type: none"> Determination of DO in the reactor
<i>Control</i>	1. Reduce the aeration level
<i>Cause 3: Composition of the influent (unbalanced nutrients)</i>	
<i>Detection</i>	<ul style="list-style-type: none"> Analyse influent and determine the BOD₅:N:P ratio Conventional activated sludge – approximate ratio: 100:5:1 Extended aeration – approximate ratio: 200:5:1

<i>Secondary causes</i>	<ul style="list-style-type: none"> • Presence of industrial wastes deficient in N and/or P • Activated sludge operating to remove N and/or P
<i>Control</i>	1. Add nitrogen or phosphorus in forms immediately available
<i>Cause 4: Excessive floc load at the entrance to the reactor</i>	
<i>Detection</i>	• Floc load = $[(\text{COD}_{\text{inf}} - \text{COD}_{\text{eff}}) \cdot Q] / (X_r \cdot Q_r)$ (mgCOD/gMLSS)
<i>Secondary causes</i>	<ul style="list-style-type: none"> • High load of influent BOD • Low concentration of MLSS at the inlet end of the reactor
<i>Control</i>	<ol style="list-style-type: none"> 1. Increase the return sludge flow, mixing it well with the influent 2. Decrease the excess sludge flow 3. In step-feed reactors, direct the influent to the points after the inlet end of the reactor

41.2.1.4 Dispersed sludge

Detection:

- Turbid effluent
- Undefined sedimentation zone
- Variable SVI

Causes:

- Excessive shearing caused by hydraulic turbulence
- Bacteria unable to aggregate themselves into flocs
- Use of centrifugal pumps to pump the sludge and of centrifuges to dewater the sludge

Detailing and correction of the causes:

(a) Excessive shearing caused by hydraulic turbulence

<i>Cause</i>	• Excessively vigorous aeration (mechanical aeration)
<i>Control</i>	<ol style="list-style-type: none"> 1. Reduce the aeration level 2. Verify the size of the aerator and the rotation speed according to the tank dimensions

(b) Bacteria unable to aggregate themselves into flocs

<i>Cause 1: Shock organic loads</i>	
<i>Control</i>	<ol style="list-style-type: none"> Control the influent flow <ul style="list-style-type: none"> Use stormwater storage tanks to reduce peaks (in combined sewerage systems) Introduce/use equalisation tanks
<i>Cause 2: Toxicity</i>	
<i>Detection</i>	<ul style="list-style-type: none"> Low oxygen utilisation rate (OUR), which suggests that toxic products are preventing the growth and respiration of the biomass and, consequently, the treatment level Non-typical DO profile in plug-flow reactors Reduction/loss of nitrification
<i>Cause</i>	<ul style="list-style-type: none"> Presence of industrial effluents
<i>Control</i>	<ol style="list-style-type: none"> Increase sludge age (reduce the excess sludge flow) Increase the MLSS concentration (reduce the excess sludge flow) Increase the DO concentration Consider the increase in the volume/number of reactors Control toxicity at the source Temporarily store toxic discharge, releasing it in small amounts, favouring dilution (if the biomass can be acclimatised to small amounts of the toxic agent) Consider modification of the reactor to increase dispersion, leading to complete mix (if the toxic loads are frequent) Divert the influent to other points further downstream in the reactor (in step-feed reactors) Study the effect of toxicity on the biomass, to evaluate possible acclimatisation Import biomass from other plants, for reseeded Temporarily bypass the biological stage
<i>Cause 3: Low concentrations of DO in the reactor</i>	
<i>Detection</i>	<ul style="list-style-type: none"> Measurement of DO in the reactor
<i>Causes</i>	<ul style="list-style-type: none"> See Section 41.2.1.2.a
<i>Control</i>	<ol style="list-style-type: none"> See Section 41.2.1.2.a
<i>Cause 4: Low pH values in the reactor</i>	
<i>Detection</i>	<ul style="list-style-type: none"> Measurement of pH in the reactor
<i>Causes</i>	<ul style="list-style-type: none"> See Section 41.2.1.2.b
<i>Control</i>	<ol style="list-style-type: none"> See Section 41.2.1.2.b

<i>Cause 4: Low sludge age (high F/M ratio)</i>	
<i>Detection</i>	<ul style="list-style-type: none"> • Measurement of the influent BOD (COD) and MLSS for calculation of the F/M ratio • Measurement of MLSS and flow and SS concentration in the excess sludge
<i>Causes</i>	<ul style="list-style-type: none"> • High load of influent BOD • Low concentration of MLSS
<i>Control</i>	<ol style="list-style-type: none"> 1. Decrease the excess sludge flow

(c) Use of centrifugal pumps to pump the sludge and of centrifuges to dewater the sludge

<i>Control</i>	<ol style="list-style-type: none"> 1. Change opening of the centrifugal pumps 2. Replace the centrifugal pumps with another type of pump 3. Add polymers to improve the solids capture in the centrifuge for thickening and/or dewatering (avoiding the return of fine solids to the system, which may eventually lead to dispersed sludge)
----------------	--

41.2.1.5 Overload of solids in the secondary sedimentation tanks (non-bulking sludge)

Detection:

- High sludge blanket level
- Low SVI
- Applied solids load higher than the maximum allowable solids load, given by the limiting solids flux

Causes:

- Insufficient capacity of the secondary sedimentation tanks in terms of surface area
- Low sludge underflow removal from the secondary sedimentation tank
- High MLSS
- High influent flow
- Large variation of the influent flow
- Insufficient capacity of the secondary sedimentation tanks in terms of sludge storage (low sidewater depth)
- Poor distribution of the influent flow to the secondary sedimentation tanks (overload in some units)
- Low temperature, increasing the viscosity of the liquid and resulting in lower settling velocities

Control:

<i>Control</i>	<ol style="list-style-type: none"> 1. Reduce the solids load applied per unit area of the sedimentation tanks <ul style="list-style-type: none"> • Reduce the MLSS concentration (increase the excess sludge flow) • Equalise the variations of the influent flow • Increase the capacity of the secondary sedimentation tanks by building new units 2. Increase the maximum allowable solids load per unit area of the sedimentation tanks <ul style="list-style-type: none"> • Increase the underflow removal from the secondary sedimentation tanks 3. Increase the sludge storage capacity <ul style="list-style-type: none"> • Store sludge temporarily in tanks (if available) • Store sludge temporarily in the reactor, by directing the influent to points further downstream (in step-feed reactors) • Increase the sludge storage capacity by raising the sidewater wall, or by building new sedimentation tanks with higher sidewater depths 4. Improve the flow distribution to the secondary sedimentation tanks, avoiding overload to some units
----------------	---

*41.2.1.6 Hydraulic overload of the secondary sedimentation tanks***Detection:**

- High sludge blanket level
- Cloudy aspect of the effluent
- Interface settling velocity lower than the hydraulic loading rate

Causes:

- High influent flow
- Large variation of the influent flow
- Poor distribution of the influent flow to the secondary sedimentation tanks (overload in some units)
- Poor sludge settleability
- Low temperature, increasing the viscosity of the liquid and resulting in lower settling velocities

Control:

<i>Control</i>	<ol style="list-style-type: none"> 1. Equalise the influent flow 2. Increase the capacity of the secondary sedimentation tanks by building new units 3. Improve the settleability of the sludge (see Sections 41.2.1.2, 41.2.1.3 and 41.2.1.4)
----------------	---

*41.2.1.7 Foam and scum***Detection:**

- Visual observation of the reactors and/or secondary sedimentation tanks

Causes:

- Intense aeration
- Filamentous organisms
- Non-biodegradable detergents

*Detailing and correction of the causes:***(a) Intense aeration**

<i>Detection</i>	<ul style="list-style-type: none"> • The foam disappears when the aerators are turned off
<i>Control</i>	<ol style="list-style-type: none"> 1. Adjust the aeration, so that the foam is restricted to the reactor

(b) Filamentous organisms

<i>Detection</i>	<ul style="list-style-type: none"> • The foam persists after the switching-off of the aerators • The foam has a brownish colour • The filamentous organisms incorporate air bubbles, forming a thick foam, which gets the brown colour due to the MLSS that gathers in it
<i>Control</i>	<ol style="list-style-type: none"> 1. Remove the microorganisms by increasing the excess sludge flow 2. Allow the foam to go from the reactor to the secondary sedimentation tank 3. Remove the foam from the secondary sedimentation tank by scum removal equipment 4. Break the foam with high-pressure water jets

c) Non-biodegradable detergents

<i>Detection</i>	<ul style="list-style-type: none"> • The foam persists after switching-off of the aerators • The foam is white
<i>Control</i>	<ol style="list-style-type: none"> 1. Control at the source (replace the detergents with biodegradable products) 2. Break the foam with high-pressure water jets 3. Use products that prevent the formation of foams

41.2.1.8 Other operational problems of the secondary sedimentation tanks

<i>Cause 1: Non-homogeneous distribution of the influent flow to the secondary sedimentation tanks</i>	
<i>Control</i>	<ol style="list-style-type: none"> 1. Adjust the distribution by changing the levels of the weirs in the flow split chamber 2. Improve the flow distribution by changing the hydraulic design of the flow division
<i>Cause 2: Sidewater depth small to absorb variations in the level of the sludge blanket in the secondary sedimentation tanks</i>	
<i>Control</i>	<ol style="list-style-type: none"> 1. Store sludge temporarily in tanks (if available) 2. Store sludge temporarily in the reactor by directing the influent to points further downstream (in step-feed reactors) 3. Increase the sludge storage capacity by raising the side-water depth, or by building new sedimentation tanks with higher side walls
<i>Cause 3: Hydraulic short circuits caused by poor design or construction of the inlets and outlets of the sedimentation tanks</i>	
<i>Control</i>	<ol style="list-style-type: none"> 1. Improve the flow distribution and the energy dissipation in the entrance to the sedimentation tanks 2. Improve the levelling of the outlet weir 3. Introduce V-notch weirs 4. Reposition the effluent collection launder, if it is very close to the inlet 5. Reanalyse the hydraulic design of the sedimentation tanks (stability of the tank in terms of Froude Number)

<i>Cause 4: High weir rate, leading to a high approaching velocity, which can resuspend the solids</i>	
<i>Control</i>	1. Introduce more weirs and effluent launders in the sedimentation tanks
<i>Cause 5: Resuspended solids on the external face of double-weir launders</i>	
<i>Control</i>	1. Suppress the external weir by raising its level
<i>Cause 6: Bottom outlet blocked in some sedimentation tanks</i>	
<i>Control</i>	1. Unblock the sludge hoppers and the sludge lines
<i>Cause 7: Poor operation of the return sludge pumps</i>	
<i>Control</i>	<ol style="list-style-type: none"> 1. Repair the sludge recirculation pumps 2. Direct the influent to the stormwater tanks (in combined sewerage systems) 3. Temporarily bypass the plant (emergency procedure)
<i>Cause 8: Poor operation of the sludge removing mechanism</i>	
<i>Control</i>	1. Repair the sludge removing mechanism

41.3 HIGH BOD CONCENTRATIONS IN THE EFFLUENT

The effluent BOD is present in two forms: particulate BOD and soluble BOD

41.3.1 High concentrations of particulate BOD

Detection:

- Determination of the SS and particulate BOD (total BOD – soluble BOD) concentrations in the final effluent

Cause:

- High SS concentrations in the final effluent (see Section 41.2)

Control:

- Control the effluent SS concentration (see Section 41.2)

41.3.2 High concentrations of soluble BOD

Detection:

- Determination of the soluble BOD concentration in the final effluent

Causes:

- Low DO concentrations in the reactor
- Insufficient MLSS concentration
- High load of influent BOD
- Large variation of the influent BOD load
- Inhibition by toxic substances
- pH outside the range from 6.5 to 8.5
- Unbalanced nutrients
- Temperature variations

Detailing and correction of the causes:

<i>Cause 1: Low DO concentrations in the reactor</i>	
<i>Detection</i>	• See Section 41.2.1.2.a
<i>Secondary causes</i>	• See Section 41.2.1.2.a
<i>Control</i>	• See Section 41.2.1.2.a
<i>Cause 2: Insufficient MLSS concentration</i>	
<i>Detection</i>	• Measurement of the MLSS concentration in the reactor
<i>Secondary causes</i>	<ul style="list-style-type: none"> • High excess sludge flow • High influent flow, transferring the biomass to the secondary sedimentation tank • Loss of solids in the secondary sedimentation tank due to sedimentation problems • Insufficient return sludge flow • Problems in the return sludge pumping
<i>Control</i>	<ol style="list-style-type: none"> 1. Reduce the excess sludge flow 2. Control the influent flow <ul style="list-style-type: none"> • Use stormwater storage tanks to reduce peaks (in combined sewerage systems) • Introduce/use equalisation tanks 3. Control the loss of solids in the secondary sedimentation tank (see Section 41.2) 4. Increase the return sludge flow 5. Repair the return sludge pumps

<i>Cause 3: High load of influent BOD</i>	
<i>Detection</i>	<ul style="list-style-type: none"> • Measurement of the influent flow and BOD concentration
<i>Control</i>	<ol style="list-style-type: none"> 1. Reduce the excess sludge flow to increase the sludge age and the biomass
<i>Cause 4: Large variation of the influent BOD load</i>	
<i>Detection</i>	<ul style="list-style-type: none"> • Measurement of the influent flow and BOD concentration
<i>Control</i>	<ol style="list-style-type: none"> 1. Reduce the excess sludge flow to increase the sludge age and the biomass 2. Increase the return sludge flow during peak periods to increase the MLSS concentration (limited to an instantaneous control) 3. Introduce/use equalisation tanks 4. Release sludge from the sludge tanks (if available) during peak loads
<i>Cause 5: Inhibition by toxic products</i>	
<i>Detection</i>	<ul style="list-style-type: none"> • See Section 41.2.1.4.b, Cause 2
<i>Control</i>	<ul style="list-style-type: none"> • See Section 41.2.1.4.b, Cause 2
<i>Cause 6: pH outside the range from 6.5 to 8.5</i>	
<i>Detection</i>	<ul style="list-style-type: none"> • See Section 41.2.1.2.b
<i>Secondary causes</i>	<ul style="list-style-type: none"> • See Section 41.2.1.2.b
<i>Control</i>	<ol style="list-style-type: none"> 1. See Section 41.2.1.2.b
<i>Cause 7: Unbalanced nutrients</i>	
<i>Detection</i>	<ul style="list-style-type: none"> • See Section 41.2.1.3, Cause 3
<i>Secondary causes</i>	<ul style="list-style-type: none"> • See Section 41.2.1.3, Cause 3
<i>Control</i>	<ol style="list-style-type: none"> 1. See Section 41.2.1.3 – Cause 3
<i>Cause 8: Temperature variations</i>	
<i>Detection</i>	<ul style="list-style-type: none"> • Measurement of temperature in the influent and/or reactor
<i>Secondary causes</i>	<ul style="list-style-type: none"> • Reduction in temperature • Increase in temperature

<i>Control</i>	<ol style="list-style-type: none"> 1. Reduction in temperature <ul style="list-style-type: none"> • Reduce the excess sludge flow, to increase MLSS and the sludge age • Reduce heat losses 2. Increase in temperature (if it is causing problems) <ul style="list-style-type: none"> • Increase the excess sludge flow, to reduce MLSS • Supplement aeration
----------------	---

41.4 HIGH AMMONIA CONCENTRATIONS IN THE EFFLUENT

41.4.1 Causes

<ul style="list-style-type: none"> • <i>Inhibition of the growth of the nitrifying bacteria</i> • <i>Insufficient MLSS concentration</i> • <i>High loads of influent ammonia</i>

41.4.1.1 *Inhibition of the growth of the nitrifying bacteria*

Causes:

<ul style="list-style-type: none"> • Low DO concentrations in the reactor • Low temperatures in the reactor • Low pH values in the reactor • Presence of inhibiting toxic substances
--

Detailing and correction of the causes:

<i>Cause 1: Low DO concentrations in the reactor</i>	
<i>Detection</i>	<ul style="list-style-type: none"> • See Section 41.2.1.2.a
<i>Secondary causes</i>	<ul style="list-style-type: none"> • See Section 41.2.1.2.a
<i>Control</i>	<ol style="list-style-type: none"> 1. See Section 41.2.1.2.a
<i>Cause 2: Low temperatures in the reactor</i>	
<i>Detection</i>	<ul style="list-style-type: none"> • Measurement of the temperature in the influent and/or reactor
<i>Control</i>	<ol style="list-style-type: none"> 1. Reduce the excess sludge flow, to increase MLSS and the sludge age 2. Increase the DO concentration 3. Reduce heat losses 4. Consider the increase in the volume/number of reactors

<i>Cause 3: Low pH values in the reactor</i>	
<i>Detection</i>	• See Section 41.2.1.2.b
<i>Secondary causes</i>	• See Section 41.2.1.2.b
<i>Control</i>	1. See Section 41.2.1.2.b
<i>Cause 4: Presence of inhibiting toxic substances</i>	
<i>Detection</i>	• See Section 41.2.1.4.b, Cause 2
<i>Control</i>	1. See Section 41.2.1.4.b, Cause 2

41.4.1.2 *Insufficient MLSS concentration*

Detection:

- See Section 41.3.2, Cause 2

Causes:

- See Section 41.3.2, Cause 2

Control:

- See Section 41.3.2, Cause 2

41.4.1.3 *High loads of influent ammonia*

Detection:

- Measurement of the influent flow and TKN concentration

Control:

1. Reduce the excess sludge flow to increase the sludge age and the biomass
2. Increase the return sludge flow during peak periods to increase the MLSS concentration (limited to an instantaneous control)
3. Introduce/use equalisation tanks
4. Release sludge from the sludge tanks (if available) during peak loads

Part Five

References

- ABNT (1989) *Projeto de estações de tratamento de esgotos*. NBR-570 (in Portuguese).
- Adelusi, A.A. (1989) The documentation of an expert system for the operational control of the activated sludge process. M.Sc. thesis, Imperial College, Univ. of London.
- AIRE-O₂ (1992) Aire-O₂ horizontal aspirator aerator. *Technical bulletin*. Minneapolis, EUA.
- Aisse, M.M., van Haandel, A.C., von Sperling, M., Campos, J.R., Coraucci, Filho B. and Alem Sobrinho, P. (1999) Tratamento final do lodo gerado em reatores anaeróbios. In *Tratamento de esgotos sanitários por processo anaeróbio e disposição controlada no solo* (coord. J.R. Campos), pp. 271–300, PROSAB (in Portuguese).
- Alem Sobrinho, P. (2001) Tratamento de esgoto e geração de lodo. In *Biossólidos na agricultura*, (eds M.T. Tsutiya, J.B. Comparini, P. Alem Sobrinho, I. Hespagnol, P.C.T. Carvalho, A.J. Melfi, W.J. Melo and M.O. Marques), p. 7–40, SABESP, USP, UNESP, (in Portuguese).
- Alem Sobrinho, P. and Jordão, E.P. (2001) Pós-tratamento de efluentes de reatores anaeróbios – uma análise crítica. In *Pós-tratamento de efluentes de reatores anaeróbios*, (coord. C.A.L. Chernicharo), pp. 491–513, PROSAB/ABES, Rio de Janeiro (in Portuguese).
- Alem Sobrinho, P. and Kato, M.T. (1999) Análise crítica do uso do processo anaeróbio para o tratamento de esgotos sanitários. In *Tratamento de esgotos sanitários por processos anaeróbios e disposição controlada no solo*, (coord. J.R. Campos), pp. 301–20, ABES, Rio de Janeiro (in Portuguese).
- Andrews, J.F. (1972) Control systems for wastewater treatment plants. *Water Research* **6**, 575–582.
- Andrews, J.F. (1974) Review paper, Dynamic models and control strategies for wastewater treatment processes. *Wat. Res.*, **8**, 261–289.
- Arceivala, S.J. (1981) *Wastewater Treatment and Disposal*, 892 p., Marcel Dekker, New York.
- ASCE (1990) *ASCE Standard. Measurement of Oxygen Transfer in Clean Water*, 2–90. 66 p. ANSI/ASCE.
- Barnes, D. and Bliss, P.J. (1983) *Biological Control of Nitrogen in Wastewater Treatment*, 146 p., E. & F.N. Spon, London.

- Beck, M.B. (1986) Identification, estimation and control of biological wastewater treatment processes. *IEE Proceedings*, 133, Pt. D (5), 254–264.
- Berthouex, P.M., Lai, W. and Darjatmoko (1989). Statistics – based approach to wastewater treatment plant operations. *J. Environ. Eng. Div. ASCE*, 115 (3), 650–671.
- Boon, A.G. (1980) Measurement of aerator performance. *Symposium on the Profitable Aeration of Wastewater* (London, 25 April 1980).
- Boyle, W.C. (1989) Oxygen transfer in clean and process water for draft tube turbine aerators in total barrier oxidation ditches. *J. Water Pollut. Control Fed.* **61**(8), 1449–1463.
- Campos, J.R. (coord.) (1999) *Tratamento de esgotos sanitários por processos anaeróbios e disposição controlada no solo*, ABES, Rio de Janeiro, (in Portuguese).
- Catunda, P.F.C. and van Haandel, A.C. (1987) Activated sludge settlers: design and optimization. *Water Sci. Technol.* **19**, 613–623.
- Catunda, P.F.C., van Haandel, A.C., Araújo, L.S. and Vilar, A. (1989) Determinação da sedimentabilidade de lodo ativado. In *Congresso Brasileiro de Engenharia Sanitária e Ambiental*, **15** (Belém, ABES, setembro 1989), pp. 53–85 (in Portuguese).
- CEC (1991) Council Directive of 21 May 1991 concerning urban wastewater treatment (91/271/EEC). Official Journal of the European Communities, No. L 135/40. Council of the European Communities.
- Charleston, L.O., Robles, A.N. and Bohórquez, S.S. (1996) Efectos de lodos activados de purga sobre el funcionamiento de un reactor UASB piloto y las características del lecho de lodo granular. In *XXV Congreso Interamericano de Ingeniería Sanitaria e Ambiental* (México, 3–7 November 1996) (in Spanish).
- Chernicharo, C.A.L. and von Sperling, M. (1993) Considerações sobre o dimensionamento de sistemas de lodos ativados de fluxo intermitente (batelada). In *Congresso Brasileiro de Engenharia Sanitária e Ambiental*, **17**, (Natal, 19–23 Setembro 1993), vol. 2, Tomo I (in Portuguese).
- Chernicharo, C.A.L., von Sperling, M., Galvão J.R., A.C., Magalhaes, C.A.C., Moreno, J. and Gariglio, L.P. (2001) An innovative conversion of a full scale extended aeration activated sludge plant by using a UASB reactor as a first step treatment: case study of Botucatu city – Brazil. *World Congress on Anaerobic Digestion (International Water Association, Antuérpia, Bélgica, Set 2001)*.
- Cliff, R.C. and Andrews, J.F. (1981a) Aeration control for reducing energy consumption in small activated sludge plants. *Water Sci. Technol.* **13**, 371–379.
- Cliff, R.C. and Andrews, J.F. (1981b) Predicting the dynamics of oxygen utilization in the activated sludge process. *J. Water Pollut. Control Fed.* **53**(7), 1219–1232.
- Coletti, F.J., Povinelli, J. and Daniel, L. A. (1997) Pós-tratamento por lodos ativados de efluentes provenientes de processos anaeróbios de tratamento de esgoto sanitário; Determinação de constantes cinéticas. In *Anais: Congresso Brasileiro de Engenharia Sanitária e Ambiental*, (19, Foz do Iguaçu, ABES, Setembro 1997) (in Portuguese).
- Cook, S.C. (1983) Systems identification and control of wastewater treatment processes in river basin management. Ph.D. thesis. Imperial College, Univ. of London.
- Copp, J., Olsson, G., Spanjers, H. and Vanrollehem, P. (eds) (2002) *Respirometry in control of the activated sludge process: Benchmarking Control Strategies*. Scientific and Technical Report 11, IWA Publishing, London.
- Coura, M.A. and van Haandel, A.C. (1999) Viabilidade técnica e econômica do digestor anaeróbio de fluxo ascendente (UASB) no sistema anaeróbio/aeróbio. In *Anais: Congresso Brasileiro de Engenharia Sanitária e Ambiental* (20, Rio de Janeiro, 1999), ABES, Rio de Janeiro, pp. 973–987 (in Portuguese).
- Daigger, G.T. (1995) Development of refined clarifier operating diagrams using an updated settling characteristics database. *Water Environ. Res.* **67**(21), 95–100.
- Daigger, G.T. and Roper Jr, R.E. (1985) The relationship between SVI and activated sludge settling characteristics. *J. Water Pollut. Control Fed.* **57**(8), 859–866.

- De Korte, K. and Smits, P. (1985) Steady state measurement of oxygenation capacity. *Water Sci. Technol.* **17**, 303–311.
- Dick, R.I. (1972) Gravity thickening of sewage sludges. *Water Pollut. Control* **71**, 368–378.
- Downing, A.L. (1978) Selected subjects in waste treatment. 3rd edn. Delft, iHE.
- Eckenfelder Jr, W.W. (1980) *Principles of Water Quality Management*, CBI, Boston, 717 p.
- Eckenfelder Jr, W.W. (1989) *Industrial Water Pollution Control*, International edn, McGraw-Hill, New York.
- Eckenfelder Jr, W.W. and Argaman, Y. (1978) Kinetics of nitrogen removal for municipal and industrial applications. In *Advances in Water and Wastewater Treatment. Biological Nutriente Removal*, (eds M.P. Wanielista and W.W. Eckenfelder Jr), pp. 23–41, Ann Arbor Science Publishers, Michigan.
- Eckenfelder, W.W. and Grau, P. (1992) *Activated Sludge Process Design and Control. Theory and Practice*, 268 p., Technomic Publishing Co, Lancaster, EUA.
- Ekama, G.A. and Marais, G.v.R. (1977) The activated sludge process. Part II – dynamic behaviour. *Water S.A.* **3**(1), 18–50.
- Ekama, G.A. and Marais, G.v.R. (1986) Sludge settleability. Secondary settling tank design procedures. *Water Pollut. Control.* **1**, 101–114.
- EPA, United States Environmental Protection Agency, Cincinatti (1987a) *The Causes and Control of Activated Sludge Bulking and Foaming*. Summary Report, United States Environmental Protection Agency, Cincinatti.
- EPA, United States Environmental Protection Agency, Cincinatti (1987b) *Design Manual. Phosphorus Removal. Technology Transfer*, 116 p., United States Environmental Protection Agency, Cincinatti .
- EPA, United States Environmental Protection Agency, Cincinatti (1993) *Manual. Nitrogen Control*. Technology Transfer, 311 p., United States Environmental Protection Agency, Cincinatti.
- Flanagan, M.J., Bracken, B.D. and Roesler, J.F. (1977) Automatic dissolved oxygen control. *J. Environ. Eng. Div., ASCE.* **103**(EE4), 707–722.
- Fróes, C.M.V. (1996) *Avaliação do desempenho da estação de tratamento de esgotos do Conjunto Habitacional de Morro Alto, com ênfase na teoria do fluxo de sólidos limite*. Dissertação de mestrado, UFMG (in Portuguese).
- Fróes, C.V. and von Sperling, M. (1995) Método simplificado para a determinação da velocidade de sedimentação com base no Índice Volumétrico de Lodo. In *Congresso Brasileiro de Engenharia Sanitária e Ambiental*, **18** (Salvador, 17–22 Setembro 1995) (in Portuguese).
- Gall, R.A.B. and Patry, G.G. (1989) Knowledge-based system for the diagnosis of an activated sludge plant. In *Dynamic Modelling and Expert Systems in Wastewater Engineering* (eds G.G. Patry and D. Chapman), Lewis Publishers, EUA.
- Goronszy, M. (1997) Industrial application of cyclic activated sludge technology. In *LAWQ Yearbook 1997*, International Association on Water Quality, pp. 35–40
- Grady, C.P.L. and Lim, H. (1980) *Biological Wastewater Treatment: Theory and Application*, Marcel Dekker, New York.
- Gray, N.F. (1991) *Activated Sludge. Theory and Practice*, Oxford University Press, Oxford.
- Handley, J. (1974) Sedimentation: an introduction to solids flux theory. *Water Pollut. Control* **73**, 230–240.
- Hartley, K.J. (1987) Performance of surface rotors in oxidation ditches: discussion. *J. Environ. Eng. Div., ASCE.* **113**(4), 919–921.
- Holmberg, U., Olsson, G. and Andersson, B. (1989) Simultaneous DO control and respiration estimation. *Water Sci. Technol.* **21**, 1185–1195.
- Horan, N.J. (1990) *Biological Wastewater Treatment Systems. Theory and Operation*, 310 p., John Wiley & Sons, Chichester.

- IAWPRC (1987) *Activated Sludge Model No. 1*. IAWPRC Scientific and Technical Reports No. 1.
- IAWQ (1995) *Activated Sludge Model No. 2*. IAWQ Scientific and Technical Reports.
- Jenkins, D., Richard, M.G. and Daigger, G.T. (1993) *Manual on the Causes and Control of Activated Sludge Bulking and Foaming*, 2^a edn, p. 193, Lewis Publishers, Londres.
- Johnstone, D.W.M., Rachwall, A.J. and Hanbury, M.J. (1979) Settlement characteristics and settlement-tank performance in the Carrousel activated sludge system. *Water Pollut. Control* **78**, 337–353.
- Johnstone, D.W.M., Rachwall, A.J. and Hanbury, M.J. (1983) General aspects of the oxidation ditch process. In *Oxidation Ditches in Wastewater Treatment*, (eds D. Barnes, C.F. Forster and D.W.M. Johnstone), pp. 41–74, Pitman Books Limited, London.
- Kamiyama, H. and Tsutiya, M.T. (1992) Lodo ativado por batelada: um processo econômico para o tratamento de esgotos em estações de grande porte. *Revista DAE* **52**(165), 1–7 (in Portuguese).
- Keinath, T.M. (1981) Solids inventory control in the activated sludge process. *Water Sci. Technol.* **13**, 413–419.
- Keinath, T.M., Ryckman, M.D., Dana, C.B. and Hofer, D.A. (1977) Activated sludge – unified system design and operation. *J. Environ. Eng. Div., ASCE.* **103**(EE5), 829–849.
- Koopman, B. and Cadee, K. (1983) Prediction of thickening capacity using diluted sludge volume index. *Water Res.* **17**(10), 1427–1431.
- Kwan, A.F. (1990) Application of an expert system for the operational control of an activated sludge plant. M.Sc. thesis, Imperial College, Univ. of London.
- Lettinga, G., Pol, L.W.H. and Zeeman, G. (1996) *Biological Wastewater Treatment. Part I. Anaerobic Wastewater Treatment*. Department of Environmental Technology, Wageningen Agricultural University, January 1996 (Lecture notes).
- Lohmann, J. and Schlegel, S. (1981) Measurement and control of the MLSS concentration in activated sludge plants. *Water Sci. Technol.* **13**, 217–224.
- Lumbers, J.P. (1982) Improving the efficiency of the process. Future research and objectives for control in the water industry. In *SERC. Water and Waste Research. The Way Ahead. Proceedings of a seminar (Imperial College, London, 17–18 June 1982)*.
- Malina, J.F. Biological waste treatment. In *Seminário de transferência de tecnologia. Tratamento de esgotos*, pp. 153–315, (ABES/WEF. Rio de Janeiro, 17–20 Aug 1992)
- Marais, G.v.R. and Ekama, G.A. (1976) The activated sludge process. Part I – steady state behaviour. *Water S.A.* **2**(4), 164–200.
- Markantonatos, P. (1988) Modelling for the operational control of the oxidation ditch process. Ph.D. thesis, Imperial College, University of London.
- Marsili-Libelli, S., Giardi, R. and Lasagni, M. (1985) Self-tuning control of the activated sludge process. *Environ. Technol. Lett.* **6**, 576–583.
- Matsui, K. and Kimata, T. (1986) Performance evaluation of the oxidation ditch process. *Water Sci. Technol.* **18**, 297–306.
- Metcalf and Eddy (1991) *Wastewater Engineering: Treatment, Disposal and Reuse*, 3rd edn, 1334 pp., Metcalf and Eddy, Inc.
- Olsson, G. and Newell, B. (1999) *Wastewater Treatment. Modelling, Diagnosis and Control*, IWA Publishing, London.
- Olsson, G., Rundqwist, L., Eriksson, L. and Hall, L. (1985) Self tuning control of the dissolved oxygen concentration in activated sludge. In *Instrumentation and Control of Water and Wastewater Treatment and Transport Systems, Proceedings of the fourth IAWPRC Workshop (Houston and Denver)*, pp. 473–480.
- Orhon, D. and Artan, N. (1994) *Modelling of Activated Sludge Systems*, Technomic Publishing Co., Lancaster, EUA.

- Passig, F.H., Vilela, L.C.H. and Ferreira, O.P. (1999) ETE – Piracicamirim – nova concepção de sistema de tratamento de esgotos sanitários – partida, operação e monitoramento de desempenho. In *Anais: 20º Congresso Brasileiro de Engenharia Sanitária e Ambiental, (Rio de Janeiro, Maio 1999)* (in Portuguese).
- Pitman, A.R. (1984) Settling of nutrient removal activated sludges. *Water Sci. Technol.* **17**, 493–504.
- Pöpel, H.J. (1979) *Aeration and Gas Transfer*. 2nd edn, 169 p., Delft University of Technology, Delft.
- Qasim, S.R. (1985) *Wastewater Treatment Plants: Planning, Design and Operation*, Holt, Rinehart and Winston, New York.
- Ramalho, R.S. (1977) *Introduction to Wastewater Treatment Processes*, 409 p., Academic Press, New York.
- Randall, C.W., Barnard, J.L. and Stensel, H.D. (1992) *Design and Retrofit of Wastewater Treatment Plants for Biological Nutrient Removal*, 420 p., Technomic Publishing Co, Lancaster, USA.
- Sampaio, A.O. and Vilela, J.C. (1993) Utilização de seletores para o controle de intumescimento filamentosos em processos de lodos ativados. Programa experimental em escala real. In *ABES: Congresso Brasileiro de Engenharia Sanitária e Ambiental, 17 (Natal, RN, 19-23 setembro 1993)* (in Portuguese).
- Sawyer, C.N. and McCarty, P.L. (1978) *Chemistry for Environmental Engineering*. 3rd edn, 532 p., McGraw-Hill, Inc., New York.
- Schlegel, S. (1977) Automation of the activated sludge process by oxygen and MLSS control. *Prog. Water Technol.*, **9** (5/6), 385–392.
- Sedlak, R. (ed) (1991) *Phosphorus and Nitrogen Removal from Municipal Wastewater. Principles and Practice*, Lewis Publishers, USA.
- Silva, S.M.C.P. and Alem Sobrinho, P. (1995) Avaliação do Sistema Reator UASB e Processo de Lodos Ativados para Tratamento de Esgotos Sanitários com Elevada parcela de Contribuição Industrial. In *Anais: Congresso Brasileiro de Engenharia Sanitária e Ambiental, 18 (Salvador, Bahia, ABES, Setembro 1995)* (in Portuguese).
- Souza, L.C.A. and Campos, J.R. (1999) Avaliação do consumo de energia elétrica dos sistemas de aeração por ar difuso com micro-bolhas e aeração mecânica para reator aeróbio precedido por reator anaeróbio em Estações de Tratamento de Esgotos sanitários. In *Assembléia Nacional da ASSEMAE, 28 (Anais)* (in Portuguese).
- Souza, J.T. and Foresti, E. (1996) Domestic sewage treatment in an upflow anaerobic sludge blanket–sequencing batch reactor system. *Water Sci. Technol.* **33**(3), 73–84.
- Stephenson, R.V. *et al.* (1985) Performance of surface rotors in an oxidation ditch. *J. Environ. Eng. Div., ASCE.* **111**(1), 79–91.
- Sveeris, S. (1969) Meting van het zuurstoftevoervermogen. *H₂O* **2**(25), 610–642.
- Takase, I. and Miura, R. (1985) Sludge flow control for activated sludge process. In *Instrumentation and Control of Water and Wastewater Treatment and Transport Systems, Proceedings of the 4th IAWPRC Workshop (Houston and Denver)*, pp. 675–678.
- Tchobanoglous, G. and Schroeder, E.D. (1985) *Water Quality: Characteristics, Modeling, Modification*, Addison-Wesley, Reading, MA.
- Tuntoolavest, M. and Grady, L.C.P. Effect of activated sludge operational conditions on sludge thickening characteristics. *J. Water Pollut. Control Fed.* **54**(7), 1112–1117.
- van Haandel, A.C. and Marais, G.v.R. (1999) *O comportamento do sistema de lodos ativados* (in Portuguese).
- van Sluis, J.W. (undated). OC-metingen in de praktijk. *H₂O*.
- von Sperling, M. (1990) Optimal management of the oxidation ditch process. Ph.D. thesis, 371 p., Imperial College, University of London.

- von Sperling, M. (1992) Métodos clássicos e avançados para o controle operacional de estações de tratamento de esgotos por aeração prolongada. In *23º Congresso Interamericano de Engenharia Sanitária e Ambiental (Havana, Cuba, 22–26 Novembro 1992)* (in Portuguese).
- von Sperling, M. (1993a) Determinação da capacidade de oxigenação de sistemas de lodos ativados em operação. In *Congresso Brasileiro de Engenharia Sanitária e Ambiental, 17 (Natal, 19–23 Setembro 1993)*, vol. 2, Tomo I, pp. 152–167 (in Portuguese).
- von Sperling, M. (1993b) Características operacionais específicas de sistemas de aeração prolongada. In *Congresso Brasileiro de Engenharia Sanitária e Ambiental, 17*, vol. 2, tomo I, pp.140–151 (in Portuguese).
- von Sperling, M. (1994a) Projeto e controle de decantadores secundários através de um novo método para a análise simplificada do fluxo de sólidos. In *VI SILUBESA – Simpósio Luso-Brasileiro de Engenharia Sanitária e Ambiental (Florianópolis-SC, 12-16 Junho 1994)*, Tomo I, pp. 479–492 (in Portuguese).
- von Sperling, M. (1994b) A new unified solids flux-based approach for the design of final clarifiers. Description and comparison with traditional criteria. *Water Sci. Technol.* **30**(4), 57–66.
- von Sperling, M. (1994c) Variações horárias de diversas variáveis em uma estação de tratamento de esgotos por lodos ativados. In *VI SILUBESA – Simpósio Luso-Brasileiro de Engenharia Sanitária e Ambiental (Florianópolis-SC, 12–16 Junho 1994)*, Tomo I, pp. 473–478 (in Portuguese).
- von Sperling, M. (1994d) Solids management for the control of extended aeration systems. An analysis of classical and advanced strategies. *Water SA* **20**(1), 49–60.
- von Sperling, M. (1996a) *Princípios do tratamento biológico de águas residuárias. Vol. 1. Introdução à qualidade das águas e ao tratamento de esgotos*, 2nd edn, 243 p., Departamento de Engenharia Sanitária e Ambiental, UFMG (in Portuguese).
- von Sperling, M. (1996b) *Princípios do tratamento biológico de águas residuárias. Vol. 2. Princípios básicos do tratamento de esgotos*, 211 p., Departamento de Engenharia Sanitária e Ambiental, UFMG (in Portuguese).
- von Sperling, M. (1996c) *Princípios do tratamento biológico de águas residuárias. Vol. 3. Lagoas de estabilização*, 134 p., Departamento de Engenharia Sanitária e Ambiental, UFMG (in Portuguese).
- von Sperling, M. (1996d) A influência da idade do lodo no dimensionamento de sistemas de lodos ativados. *Engenharia Sanitária e Ambiental (ABES)*, Ano 1, **1**(1), Jan/Mar, 18–27 (in Portuguese).
- von Sperling, M. (1998) A new method for the design of sequencing batch reactors (SBR) using the concept of the hindered settling velocity of the sludge. *Environ. Technol.* **19**, 1223–1231.
- von Sperling, M. (2002) *Princípios do tratamento biológico de águas residuárias. Vol. 4. Lodos ativados*. 2nd edn, 428 p., Departamento de Engenharia Sanitária e Ambiental, UFMG (in Portuguese).
- von Sperling, M., Freire, V.H. and Chernicharo, C.A.L. (2001a) Performance evaluation of a UASB – activated sludge system treating municipal wastewater. *Water Sci. Technol.* **43**(11), 323–328.
- von Sperling, M. and Fróes, C.M.V. (1998) Dimensionamento e controle de decantadores secundários com base em uma abordagem integrada e simplificada da teoria do fluxo de sólidos. *Engenharia Sanitária e Ambiental (ABES)*. **3**(1/2), Jan/Jun, 42–54 (in Portuguese).
- von Sperling, M. and Fróes, C.M.V. (1999) Determination of the required surface area for activated sludge final clarifiers based on a unified database. *Water Res.***33**(8), 1884–1894.
- von Sperling, M. and Gonçalves, R.F. (2001b) Lodo de esgotos: características e produção. In *Princípios do tratamento biológico de águas residuárias. Vol. 6. Lodo de esgotos*.

- Tratamento e disposição final*, (eds C.V. Andreoli, M. Von Sperling and F. Fernandes), pp.17–67 Departamento de Engenharia Sanitária e Ambiental – UFMG. Companhia de Saneamento do Paraná – SANEPAR. (in Portuguese).
- von Sperling, M. and Lumbers, J.P. (1988) Controle operacional e otimização de custos em sistemas de aeração prolongada. In *21º Congresso Interamericano de Engenharia Sanitária e Ambiental (Rio de Janeiro, 18–23 Setembro 1988)*, pp. 171–191 (in Portuguese).
- von Sperling, M. and Lumbers, J.P. (1989a) Control objectives and the modelling of MLSS in oxidation ditches. *Water Sci. Technol.* **21**, 1173–1183.
- von Sperling, M. and Lumbers, J.P. (1989b) Control objectives and the modelling of MLSS in oxidation ditches (discussion). *Water Sci. Technol.* **21**(12), 1621–1622.
- von Sperling, M. and Lumbers, J.P. (1991a) Optimization of the operation of the oxidation ditch process. *Water Sci. Technol.* **24**(6), 225–233.
- von Sperling, M. and Lumbers, J.P. (1991b) Operational rules for the optimal management of the oxidation ditch process for wastewater treatment. In *Advances in Water Resources Technology* (ed. G. Tsakiris) (*Conference in Athens, March 1990*), pp. 387–395, Balkema, Rotterdam.
- von Sperling, M., Van Haandel, A.C., Jordão, E.P., Campos, J.R., Cybis, L.F., Aisse, M.M. and Alem Sobrinho, P. (2001c) Capítulo 5: Tratamento de efluentes de reatores anaeróbios por sistema de lodos ativados. In *Pós-tratamento de efluentes de reatores anaeróbios* (coord. C.A.L. Chernicharo) (*PROSAB/ABES, Rio de Janeiro*), pp. 279–331 (in Portuguese).
- Wahlberg, E.J. and Keinath, T.M. (1988) Development of settling flux curves using SVI. *J. Water Pollut. Control Fed.* **60**(12), 2095–2100.
- Wahlberg, E.J. and Keinath, T.M. (1995) Development of settling flux curves using SVI: an addendum. *Water Environ. Res.* **67**, 872.
- Wanner, J. (1994) *Activated Sludge Bulking and Foaming Control*, 327 p., Technomic Publishing Co., Lancaster, EUA.
- WEF (1990) *Operation of Municipal Wastewater Treatment Plants*. Manual of Practice 11. Water Environment Federation, EUA.
- WEF and ASCE (1992) *Design of Municipal Wastewater Treatment Plants*, 1592 p., Water Environment Federation/American Society of Civil Engineers.
- White, M.J.D. (1976) Design and control of secondary settlement tanks. *Water Pollut. Control* **75**, 459–467.
- Winkler, M. (1981) *Biological Treatment of Waste-water*, 301 p., Ellis Horwood Publishers, Chichester.
- WPCF and ASCE (1988) *Aeration. A Wastewater Treatment Process*. Manual of Practice FD-13 (WPCF), Manuals and reports on engineering practice No. 63 (ASCE), 167 p.
- WRC (1984) *Theory, Design and Operation of Nutrient Removal Activated Sludge Processes*. Water Research Commission (South Africa).
- WRC (1990) *Design Guidelines for Activated Sludge Process*. Chapter 2. *Bulking of Activated Sludge*, 41 p., Foundation for Water Research, UK.

PART SIX

Aerobic biofilm reactors

42	Basic principles of aerobic biofilm reactors	1113
43	Trickling filters	1119
44	Rotating biological contactors	1135
45	Submerged aerated biofilters	1142
	References	1161

Basic principles of aerobic biofilm reactors

R.F. Gonçalves

42.1 INTRODUCTION

New versions of wastewater treatment plants using biofilm reactors are compact, capable of being installed in urban areas with relatively low impacts (Rogalla *et al.*, 1992) and, above all, highly resistant to variations in temperature and to toxicity shock loads (Arvin and Harremöes, 1991). Operational stability is important in the case of small treatment plants, this being one of the reasons for the renewed interest in several locations for the “old” trickling filters and biodiscs (rotating biological contactors) for small-sized communities (Upton and Green, 1995). A similar interest to biofilm reactors applied to medium and large communities occurred in developed regions (e.g., USA), after the development of processes combining biomass in suspension with biomass attached to a support medium (Parker *et al.*, 1990). The process advantages renewed the interest for systems with attached biomass, stimulating the development of a great variety of processes.

The main concepts and technical aspects relative to biofilm reactors applied to wastewater treatment and the post-treatment of effluents from anaerobic reactors are presented in this chapter. The classification of the main types of biofilm reactors with relation to suspended-biomass reactors, as well as the behaviour of the biofilm and the influence of the transport phenomenon during reactions, is discussed.

Usual configurations, as well as new configurations for the post-treatment of effluents from anaerobic reactors, are also presented in Part 6, including some design examples, main construction aspects and more common operational problems. Part 6 deals mainly with the following processes:

- trickling filters
- rotating biological contactors (biodiscs)
- submerged aerated biofilters

Due to the great importance of UASB reactors in warm-climate regions, emphasis is given to aerobic biofilm reactors acting as post-treatment for anaerobic effluents.

The chapters in Part 6 are based essentially on Gonçalves *et al.* (2001).

42.2 CLASSIFICATION OF AEROBIC BIOFILM REACTORS

A better understanding of the mechanisms involved in the conversion processes taking place in biofilm reactors led to the development of new reactors from 1970 (Atkinson, 1981). Improvements concerning mixing of phases, oxygen transfer and separation of phases were incorporated, improving performance through an effective control of the biofilm thickness and an increment of the mass transfer.

Figure 42.1 (Lazarova and Manen, 1994) presents an alternative classification of aerobic reactors, based on the state of biomass fixation. The major difference with relation to old similar classifications is the group of hybrid reactors, which incorporate suspended biomass and fixed biomass in the same reaction volume. The processes with suspended biomass involve several variants of activated sludge. Among the hybrid processes, there are those with the support medium mechanically mixed (Oodegard *et al.*, 1993) and with structured supports inserted in the aeration tank (Bonhomme *et al.*, 1990). Both are variants of the activated sludge systems,

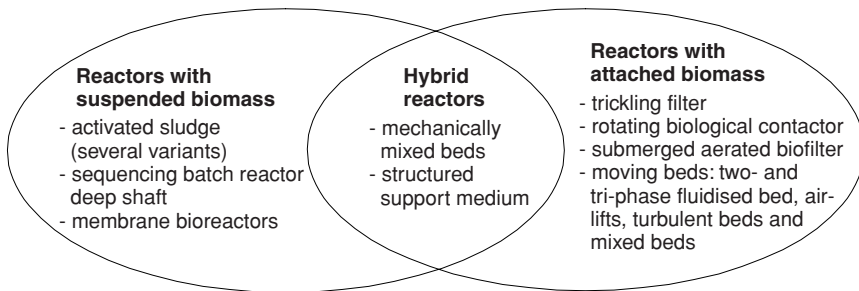

Figure 42.1. Modern classification of mechanised aerobic treatment processes, with respect to the state of the biomass (adapted from Lazarova and Manen, 1994)

since they result from the incorporation of the support medium in the aeration tank. This technique has been used to upgrade overloaded treatment plants, because the applied organic load can even be three times higher compared to that in the conventional process (Lessel, 1993).

Reactors with attached biomass, or simply biofilm reactors, now include, besides trickling filters and rotating biological contactors, several other types of reactors with fixed or moving beds. Processes with moving beds have the support medium in permanent movement, hydraulically or mechanically driven. They generally use a material with large specific surface area for the attachment of the biomass, that can be grains of small diameter (0.2 to 2 mm) or a material with high porosity (e.g., sponges). High biomass concentrations are reached in these processes ($>20 \text{ kg TSS/m}^3$), resulting in a high treatment capacity. Their main advantage with relation to fixed bed processes is the absence of clogging of the filter medium, and their main disadvantages are the high operational costs (especially energy) and the sophisticated devices necessary for appropriate flow distribution and aeration. Among the main processes, the two-phase fluidised bed reactors stand out, counting with many full-scale treatment plants operating in the USA and in Europe (Lazarova and Manen, 1994). Indicated for the treatment of diluted effluents, their construction costs are reported to be lower than that of activated sludge systems, although the operation and maintenance costs may be higher (due to the saturation in oxygen and pumping).

42.3 FORMATION, STRUCTURE AND BEHAVIOUR OF BIOFILMS

Theoretical aspects about reaction mechanisms in biofilm reactors were presented in Chapter 7. The present item includes additional details.

In all reactors with attached biomass, the metabolic conversion processes take place inside the biofilm. Substrate transport occurs by diffusion processes, initially through the liquid film in the liquid/biofilm interface and later through the biofilm (Figures 42.2 and 42.3). The products of the oxidation and reduction reactions are transported in the opposite direction, to the exterior of the biofilm. The substrate donor as well as the electron acceptor must penetrate the biofilm for the biochemical reaction to take place.

The quantification of the limitations to the mass transfer is very important, so that better performance reactors can be designed. Improvement of performance is directly related with the reduction of these limitations, because the global reaction velocity in these heterogeneous systems may be lowered due to the mass transfer among the phases (Zaiat, 1996).

In many aerobic systems, the rate of oxygen transfer to the cells is the limiting factor that determines the biological conversion rate. Oxygen availability for microorganisms depends on the solubility and mass transfer, as well as on the rate at which dissolved oxygen is utilised. In biofilm reactors used for post-treatment of anaerobic effluents, the transport mechanisms involve oxygen and ammonia

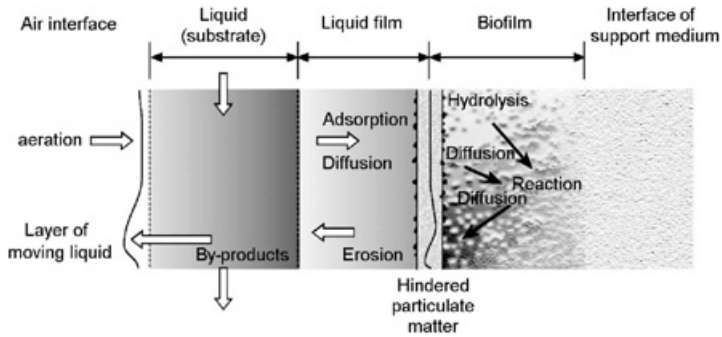

Figure 42.2. Mechanisms and processes involved with the transport and substrate conversion in biofilms

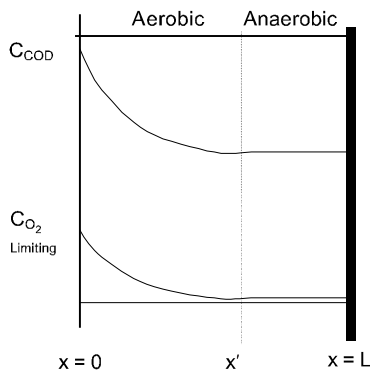

Figure 42.3. Distribution of the concentration of two compounds involved in oxidation-reduction reaction in the biofilm (O_2 and COD)

nitrogen (O_2 and $N-NH_4^+$), besides the intermediate ($N-NO_2^-$) and final nitrogen product ($N-NO_3^-$). The main stages involved are:

- transfer of oxygen from the gaseous phase to the liquid medium
- transfer of oxygen, ammonia and nitrate from the liquid phase to the biofilm
- transfer of oxygen, ammonia and nitrite inside the biofilm
- transfer of the intermediary product ($N-NO_2^-$) and of the final product ($N-NO_3^-$) to the liquid medium

According to Chisti *et al.* (1989), oxygen, being poorly soluble in water, frequently becomes the limiting factor in aerobic biofilm processes. The main oxygen transport steps are illustrated in Figure 42.4, in which eight possible resistant structures to mass transfer are identified.

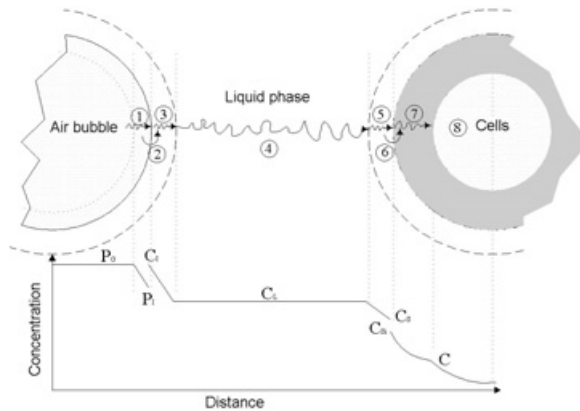

Figure 42.4. Schematic diagram of the stages involved in the transport of oxygen (adapted from Bailey and Ollis, 1986, cited by Fazolo, 2000)

The resistances considered in the tri-phase systems are:

1. in the gaseous film inside the bubble, between the core of the gas in the bubble and the gas–liquid interface
2. in the gas–liquid interface
3. in the liquid film, close to the gas–liquid interface, between this interface and the liquid medium
4. in the liquid medium
5. in the liquid film, between the liquid medium and the liquid–solid interface (external resistance)
6. in the liquid–solid interface
7. in the solid phase (internal resistance)
8. in the sites of biochemical reaction (inside the microorganisms)

The relative magnitude of these resistances depends on the hydrodynamics of the bubble, solubility of oxygen, temperature, cellular activity, composition of the solution and interface phenomena (Bailey and Ollis, 1986). Therefore, the penetration depth of the substrates in the biofilm is of fundamental importance in the determination of the global conversion rate in the reactor. The ideal situation corresponds to a biofilm completely penetrated by the two substrates, resulting in a reaction limited only by the maximum rate of biochemical reaction.

However, the most common situation in the treatment of domestic sewage is the partial penetration of at least one of the two substrates in a thick biofilm layer, caused by an intrinsic volumetric high conversion rate and a great resistance to the diffusion in the biofilm (Figure 42.3). In this case, only the fine outer biofilm layer will be active with respect to the reaction in question, with the remaining biomass being inactive in the deepest layers. An intrinsically zero-order biochemical reaction may become half order, decreasing the overall surface conversion rate (Harremöes, 1982).

In the case of systems with nitrification, the critical ratio between the O_2 and NH_4^+ concentrations, that determines the limiting substrate, is between 0.3 and 0.4 (Gönenc and Harremöes, 1985). This makes oxygen the limiting substrate in most cases. Assuming, for example, a concentration of 2 mg/L of O_2 in the liquid phase of the reactor, the limiting ammonia concentration will be 0.6 mg/L. In the case of simultaneous oxidation of organic matter and nitrification, the competition between the heterotrophic and autotrophic (nitrifying) bacteria for oxygen determines the structure of the aerobic biofilm compartment. When the O_2/COD ratio is very small, the aerobic compartment is entirely dominated by the heterotrophic bacteria, and nitrification does not take place in the biofilm (Gönenc and Harremöes, 1990).

The understanding of these mass-transfer mechanisms is reflected in the configuration of the various new-generation biofilm reactors. In the case of submerged aerated biofilters, there prevail granular mediums with high specific surface that maximise the area for mass transfer and the amount of biomass in the reactor. With the use of granular mediums, high sludge ages are obtained without the need for clarification and biomass recirculation.

On the other hand, the severe hydrodynamic conditions in the biofilters precipitate the development of a fine and very active biofilm, especially in the bed layers that do not have contact with the settled wastewater. Hydraulic loads of 2 $m^3/m^2 \cdot hour$ (wastewater) and 15 $m^3/m^2 \cdot hour$ (air) are commonly practised in secondary treatment, resulting in a granular tri-phase medium submitted to a high turbulence. The association of the turbulence and the high velocity of the liquid controls the biofilm thickness and decreases the resistance to diffusion in the liquid film. Besides, high air flows increase the oxygen concentration in the liquid phase, facilitating its diffusion in the biofilm.

The stability of the process to temperature variations and toxic shock loads is also a consequence of the resistance to the diffusion in the biofilm (Arvin and Harremöes, 1991). The thickness of the active biofilm layer increases when the liquid temperature decreases, significantly reducing the sensitivity of the process to temperature variations (Okey and Albertson, 1987). Regarding nitrification, two factors resulting from the temperature drop contribute to alleviate the reduction in efficiency: increase in the DO concentration in the liquid (increasing diffusion) and decrease in biological activity (reducing conversion rates).

With respect to the resistance to toxicity shocks, the process behaves in a similar way to temperature drop. If the concentration of a certain toxic compound suddenly exceeds the inhibition threshold, the gradient of concentrations through the biofilm attenuates its impact on the treatment. Even if the outer biofilm layers are affected, the inner layers continue to degrade the concentrations reduced by the resistance to diffusion (Saez *et al.*, 1988).

The great capacity to tolerate shock loads, in spite of the low real hydraulic detention times in the granular medium of biofilters (≈ 20 minutes), is due to the high biomass concentration in the reactors. Biomass concentrations higher than 20 gTSS/L are found in biofilters with granular mediums (specific surface $> 600 m^2/m^3$) applied to secondary treatment of domestic sewage (Gonçalves, 1993).

43

Trickling filters

C.A.L. Chernicharo, R.F. Gonçalves

43.1 DESCRIPTION OF THE TECHNOLOGY

43.1.1 Preliminary considerations

Trickling filters (TF) are wastewater treatment systems that can be widely used in developing countries, principally in view of their simplicity and low operational costs.

A trickling filter consists of a tank filled with a packing medium made of a material of high permeability, such as stones, wooden chips, plastic material or others, on top of which wastewater is applied in the form of drops or jets. After the application, the wastewater percolates in the direction of the drainage system located at the bottom of the tank. This downward percolation allows bacterial growth on the surface of the packing medium, in the form of a fixed film denominated biofilm. The wastewater passes over the biofilm, promoting contact between the microorganisms and the organic matter.

Trickling filters are aerobic systems, because air circulates in the empty spaces of the packing medium, supplying oxygen for the respiration of the microorganisms. Ventilation is usually natural. The application of wastewater on the medium is done frequently through rotating distributors, moved by the hydraulic head of the liquid. The wastewater quickly drains through the support medium. However, the organic matter is absorbed by the biofilm and is retained for a time sufficient for its stabilisation (see Figure 43.1).

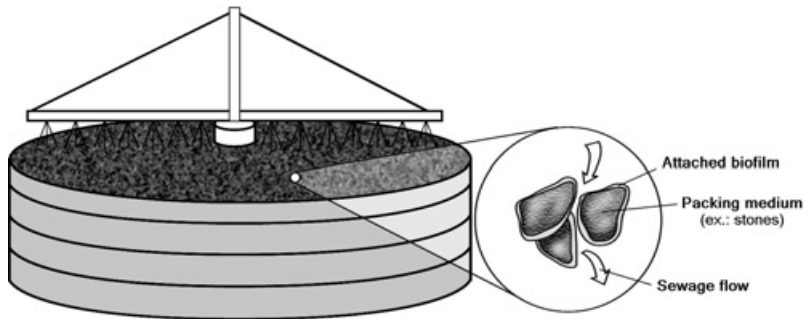

Figure 43.1. Schematic representation of a trickling filter

The filters are usually circular, and can be several metres in diameter. Contrary to what the name indicates, the primary function is not filtering. The diameter of the stones (or other medium) used is in the order of centimetres, leaving a large space between them, which is inefficient for the act of filtering (sieving action). The function of the medium is only to supply a support for the formation of the microbial film. Synthetic mediums of several materials and forms also exist, having the advantage of being lighter than stones, besides presenting a greater surface area. However, the synthetic mediums are more expensive.

With the continued biomass growth on the surface of the stones, the empty spaces tend to decrease, thus increasing the downward velocity through the pores. When the velocity reaches a certain value, it causes a shearing stress that dislodges part of the attached material. This is a natural form of controlling the microbial population on the support medium. The dislodged sludge should be removed in the secondary settling tank to decrease the level of suspended solids in the final effluent.

43.1.2 Types of trickling filters

The trickling filters are generally classified according to the surface or the organic loading rate to which they are submitted, as described below. The main design criteria are presented in Table 43.1.

Low rate trickling filter

The low rate trickling filter is conceptually simple. Although its efficiency in the removal of BOD is comparable to that of the conventional activated sludge system, its operation is simpler, although less flexible. Trickling filters have lesser capacity in adjusting to influent flow variations, besides requiring a slightly higher total area. In terms of energy consumption, they have much lower consumption than activated sludge systems. Figure 43.2 presents the typical flowsheet of a low rate trickling filter.

Table 43.1. Typical characteristics of the different types of trickling filters

Operational conditions	Low rate	Intermediate rate	High rate	Super high rate	Roughing
Packing medium	Stone	Stone	Stone	Plastic	Stone/plastic
Hydraulic loading rate ($\text{m}^3/\text{m}^2\cdot\text{d}$)	1.0 to 4.0	3.5 to 10.0	10.0 to 40.0	12.0 to 70.0	45.0 to 185.0
Organic loading rate ($\text{kgBOD}/\text{m}^3\cdot\text{d}$)	0.1 to 0.4	0.2 to 0.5	0.5 to 1.0	0.5 to 1.6	Up to 8
Effluent recycle	Minimum	Occasional	Always*	Always	Always
Flies	Many	Variable	Variable	Few	Few
Biofilm loss	Intermitt.	Variable	Continuous	Continuous	Continuous
Depth (m)	1.8 to 2.5	1.8 to 2.5	0.9 to 3.0	3.0 to 12.0	0.9 to 6.0
BOD removal (%)**	80 to 85	50 to 70	65 to 80	65 to 85	40 to 65
Nitrification	Intense	Partial	Partial	Limited	Absent

* Effluent recycle is usually unnecessary when treating effluents from anaerobic reactors

** Typical BOD removal ranges for TF fed with effluents from primary settling tanks. Lower efficiencies are expected for TF fed with effluents from anaerobic reactors, although overall efficiency is likely to remain similar

Source: Adapted from Metcalf and Eddy (1991) and WEF (1996)

Trickling filters can have circular or rectangular shape, the most commonly used packing material is stone, and feeding can be continuous or intermittent. Dosing siphons are usually used in the case of intermittent feeding, which is common in low rate trickling filters. The interval between loads can vary as a function of the wastewater flow, but should be short enough to avoid drying of the biofilm. Effluent recirculation may be necessary to assure humidity of the medium, especially in the hours of low influent flow, although a low rate filter does not require this practice in other hours of the day.

As a result of the small load of BOD applied to the trickling filter, per unit volume, food availability is low. This leads to a partial stabilisation of the sludge (self-consumption of the cellular organic matter) and to a larger efficiency in the removal of BOD and in nitrification. This smaller BOD load per unit volume of the tank is associated with the larger area requirements, when compared to the high rate trickling filter system. One of the main problems of low rate trickling filters is the development of flies.

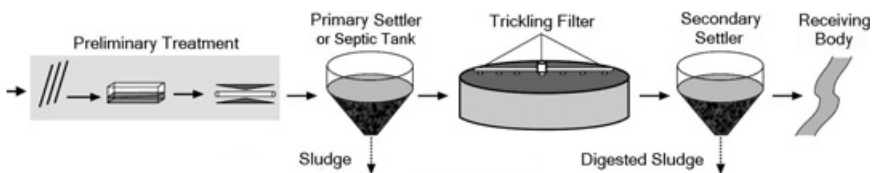

Figure 43.2. Typical flowsheet of a low rate trickling filter

Intermediate rate trickling filter

These filters are designed with higher loading rates than those of the low rate filters. The most common type is the continuous feeding flow, although intermittent feeding can also be practised. Recirculation of the treated effluent is usually carried out, aiming at the control of the thickness of the biofilm and improvement of the efficiency of the system. The effluent produced is partially nitrified, and a reasonable development of flies is still observed.

High rate trickling filter

These filters are submitted to loading rates much higher than those applied to low rate and intermediary rate filters. As a consequence of the higher organic loading rates, high rate TFs have smaller area requirements. In parallel, there is also a slight reduction in the removal efficiency of organic matter, and the non-stabilisation of the sludge in the filter. Hydraulic loading rates can reach $60 \text{ m}^3/\text{m}^2\cdot\text{d}$ in the peak hours, while the organic loading rates can be as high as $1.80 \text{ kgBOD}/\text{m}^3\cdot\text{d}$, for filters with plastic medium. In filters filled with synthetic material, the depth can exceed 6.0 m.

Feeding of high rate TF is continuous and effluent recycle is regularly practised, but only when settled wastewater is applied, to have an influent BOD concentration to the filter around 100 mg/L. Effluent recycle is usually unnecessary when TFs are used for the post-treatment of effluents from UASB reactors, since the influent BOD is typically close to 100 mg/L. The high hydraulic loading rate constantly limits the thickness of the biofilm. Due to the high application rates, BOD removal in this process is lower, in the range from 70% to 80%, and the solids produced have more difficulty in settling in the clarifier. Flies do not develop and nitrification is partial with lower loading rates. Figure 43.3 presents a typical flowsheet of a high rate trickling filter system.

Super high rate trickling filter

Filters with super high rates are generally packed with synthetic granular mediums, with depths varying between 3.0 and 12.0 m. These large depths are possible due to the low density of the packing material, which results in a lower weight on the bottom slab of the filter. Flies do not develop in the filter and nitrification does not occur.

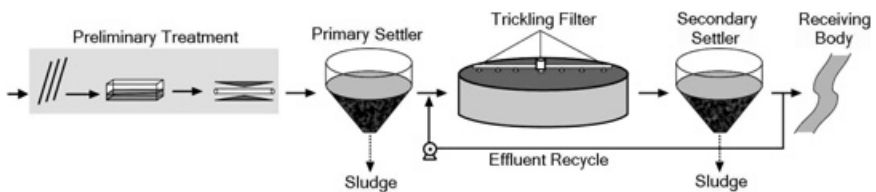

Figure 43.3. Typical flowsheet of a high rate trickling filter

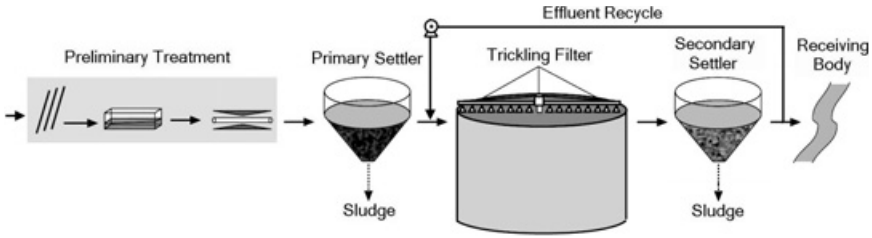

Figure 43.4. Typical flowsheet of a super high rate trickling filter

Roughing trickling filter

Roughing trickling filters are used in the pre-treatment of wastewater, upstream of secondary treatment. The packing material is synthetic and feeding is continuous. They are more commonly used for the treatment of highly concentrated wastewaters. Their use has been greatly reduced after the development of UASB reactors that are used in the place of the roughing filters.

A summary of the main characteristics of the different types of trickling filters is presented in Table 43.1.

43.2 DESIGN CRITERIA

The design criteria presented in this item mainly originated from the experience in the application of trickling filters for the treatment of primary effluents, that is, after the passage of the wastewater to a primary, or equivalent, settling tank (Metcalf and Eddy, 1991; WEF, 1996). The design criteria are also adapted to the application of TFs as post-treatment of effluents from UASB reactors.

(a) Hydraulic loading rate

The hydraulic loading rate (HLR or L_h) refers to the volume of wastewater applied daily to the TF per unit surface area of the packing medium

$$L_h = \frac{Q}{A} \quad (43.1)$$

where:

- L_h : hydraulic loading rate ($\text{m}^3/\text{m}^2 \cdot \text{d}$)
- Q : average influent flowrate (m^3/d)
- A : surface area of the packing medium (m^2)

Typical values of hydraulic loading rates are presented in Table 43.1. In the case of high rate trickling filters used for the post-treatment of effluents from UASB reactors, it has been observed that TFs are capable of producing effluents with BOD and SS lower than 60 mg/L when operated with maximum hydraulic loading rates in the order of 20 to 30 $\text{m}^3/\text{m}^2 \cdot \text{d}$.

(b) Organic loading rate

The volumetric organic load refers to the amount of organic matter applied daily to the trickling filter, per unit volume of the packing medium.

$$L_v = \frac{Q \times S_0}{V} \quad (43.2)$$

where:

L_v : volumetric organic loading rate (kgBOD/m³·d)

Q : average influent flowrate (m³/d)

S_0 : influent BOD concentration (kgBOD/m³)

V : volume occupied by the packing medium (m³)

Typical organic loading rates are presented in Table 43.1. In the case of post-treatment of anaerobic effluents, satisfactory BOD concentrations have been achieved in the effluent from TFs operating with maximum organic loading rates in the range from 0.5 to 1.0 kgBOD/m³·d.

(c) Influent distribution system

To optimise the treatment efficiency of the trickling filters, the growth as well as the elimination of the biofilm that grows in excess should happen in a continuous and uniform way. To achieve this, the distribution system should be designed in a way to facilitate the appropriate application of wastewater on the packing medium.

The feeding of TF with wastewater can be accomplished through fixed or mobile (rotating) distributors. The first TFs were fitted with fixed distribution systems, composed of pipes with nozzles. This type of system is still used today, mainly in small-scale plants. However, most of the TFs have a circular shape and are equipped with a rotating distribution system.

Fixed distribution systems

Fixed distribution systems are composed of main distribution pipes and lateral pipes, both placed just above the surface of the granular medium. The nozzles are installed in the laterals, and are designed and spaced to obtain uniform feeding distribution. In general, the nozzles are made of a circular hole and a deflector.

Most of the older fixed systems were planned considering intermittent feeding of the wastewater through a dosing tank. The flow from this device is variable, due to the variation of the water level in the dosing tank. In the beginning of the discharge period, the wastewater is discharged at a maximum distance of each nozzle, decreasing as the tank empties. The period between wastewater loads varies from 0.5 to 5 minutes.

With the appearance of the synthetic packing mediums, the fixed distribution systems returned to be used in the deep filters and in the biotowers. In these processes, the distribution system is also equipped with mains and lateral distributors, placed immediately above the support medium, and the feeding is continually accomplished through pumping.

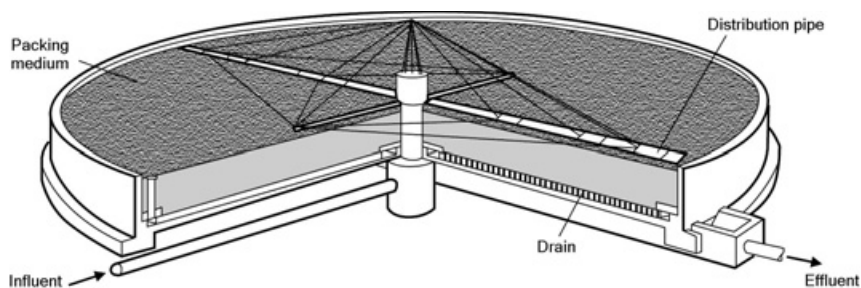

Figure 43.5. Schematics of a trickling filter with a rotating distribution system.
Source: Adapted from Metcalf and Eddy (1991)

The main disadvantages of this type of distribution system are the non-uniformity of the hydraulic load on the surface of the TF, the great lengths of distribution pipes, the frequent blockage of the nozzles, and the difficulty of maintenance of the nozzles in large TFs.

Rotating distribution systems

The rotating distribution system is composed of one or more horizontal pipes (arms), supported by a rotating central column (see Figure 43.5).

Wastewater is evenly distributed onto the packing medium by means of holes placed in one of the sides of each horizontal arm. The rotational movement of the distributor is generally assured by the energy from the jet of wastewater discharged through the group of holes. In exceptional cases, especially for control of flies and to avoid stops of the distributor arms in hours of very low influent flow rate, electric motors are also used to move the distribution system. The distributor arms usually have a circular section but can also be built with rectangular section or other quadrilateral type. A fast-opening device installed in the extremity allows the removal of coarse solids accumulated inside each arm. The area of the cross section of the arms generally decreases with the distance from the central column. The spacing among the holes is designed to guarantee a uniform distribution of the wastewater over the entire surface of the packing medium. Deflectors made of plastic or other types of non-corrosive materials are installed in front of the holes to ensure better distribution.

The arms should be designed so that the rotational velocity is between 0.1 and 2 rpm and the velocity does not exceed 1.2 m/s at the maximum flow. Filters with four-arm distributors are equipped with an overflow device in the central column, which concentrates the feeding in only two arms in periods of low flows. In periods of maximum flows, all the four arms are fed with wastewater. This procedure assures adequate discharge velocities and reaction forces for the distributor's rotation, under various flow conditions. Holes on the opposite side of the arms are also used to reduce the rotational velocity in moments of peak flow. The distributor arms also have ventilation tubes, to avoid the accumulation of air inside them. The

support structure of the arms is composed of cables, which assure the stability of the support in the central column.

(d) Packing medium

The packing medium of the trickling filter is of fundamental importance in the performance of the process. The packing material serves as support for the growth of the biomass, through which the pre-treated wastewater percolates. The air passes through the empty spaces of the medium, supplying oxygen for the aerobic reactions. The ideal packing material should have the following main characteristics:

- have the capacity to remove high BOD loads per unit volume
- have the capacity to operate at high hydraulic loading rates
- have an appropriately open structure, to avoid obstructions due to biomass growth and to guarantee an appropriate supply of oxygen, without the need for forced aeration
- have structural resistance to support its own weight and the weight of the biomass that grows attached onto its surface
- be sufficiently light, to allow significant reductions in the cost of the construction works
- be biologically inert, not being attacked by nor being toxic to the process microorganisms
- be chemically stable
- have the smallest possible cost per unit of organic matter removed

In practice, the TF is usually packed with different types of stones, such as gravel with a diameter between 5 and 8 cm, without flat and elongated stones, or blast furnace slag. These materials have a low specific surface area (55 to 80 m²/m³) and porosity from 55 to 60%, limiting the area for biomass growth and the circulation of air. TF with a stone bed can also present problems of blockage of the void spaces, due to the excessive growth of the biological film, especially when the filters are operated with high organic loads. In these conditions, floods and failures of the system can occur.

Sometimes, due to the need for reduction of the area required for the system and to overcome the limitations of the stone packing medium, other types of materials can be used (Figure 43.6) These materials include corrugated plastic modules and plastic rings, with very large specific surface areas (100 to 250 m²/m³) and with porosities from 90 to 97%, that allow a larger amount of attached biomass per unit volume of the packing material. These materials are also much lighter than stones (about 30 times), allowing the filters to be much higher, without causing structural problems. While in stone filters the heights are usually lower than 3 m, the filters packed with synthetic material can be much higher (6 m or more), decreasing, as a consequence, the area required for their installation. The use of these packing materials allows the application of much higher organic loading rates than those used for filters packed with stones, for the same treatment

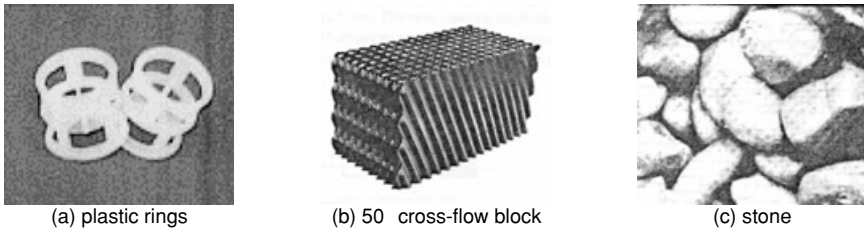

Figure 43.6. Some types of packing mediums used in trickling filters

performance. However, the high costs of these materials are usually the limiting factor.

In the case of the use of TF for the post-treatment of effluents from UASB reactors, the Brazilian experience shows that high rate TFs are capable of producing effluents with satisfactory BOD concentrations when they are built with packing medium with heights between 2.0 and 3.0 m.

(e) Underflow collection system

The underflow system of a trickling filter consists of a perforated slab, or of grids made of resistant materials, and gutters located in the lower part of the filter. The drainage system has the function of collecting the wastewater that percolates through the filter as well as the solids that are released from the packing medium, directing them to the secondary settling tank. The drainage system must be resistant enough to support the weight of the packing medium, of the attached biomass and of the wastewater that percolates through the filter. (Metcalf and Eddy, 1991).

The bottom structure should have a slope between 1 and 5%, sufficient to allow the drainage of the effluent to the centre or the periphery of the filter. The effluent collection gutters should be designed to guarantee a minimum velocity of 0.6 m/s (average feeding flow). (Metcalf and Eddy, 1991).

The bottom drainage system should be opened at both ends to facilitate inspection and occasional cleaning with water jets, should the need arise. The bottom drainage system is also responsible for the ventilation of the filter, as discussed in the following item.

(f) Ventilation

Ventilation is important to maintain aerobic conditions, necessary for the effective treatment of the wastewater. If there are adequate openings, the difference between the air and the liquid temperatures is enough to produce the necessary aeration. A good ventilation through the filter bottom is desirable. In practice, the following measures are adopted to have adequate natural ventilation (Metcalf and Eddy, 1991):

- the drainage system and the effluent collection channels close to the bottom of the TF structure should allow free flow of air. These effluent collection

Table 43.2. Surface hydraulic loading rates for the design of secondary settling tanks after TF

Treatment level	Surface hydraulic loading rate ($\text{m}^3/\text{m}^2\cdot\text{d}$)	
	For Q_{average}	For Q_{maximum}
BOD = 20 to 30 mg/L without nitrification	16 to 32	40 to 48
BOD \leq 20 mg/L with nitrification	16 to 24	32 to 40

channels should not have more than 50% of their height occupied by the effluent

- ventilating access ports with open grating types of covers should be installed at both ends of the central effluent collection channel
- large-diameter filters should be equipped with collection channels in branches, with ventilating manholes or vent stacks along the perimeter of the filter
- the open area of the slots at the top of the underdrain blocks should not be less than 15% of the surface area of the filter
- one square metre gross area of open grating in ventilating manholes and vent stacks should be provided for each 23 m^2 of surface area of the filter

(g) Secondary sedimentation tanks

The secondary settling tanks used downstream of the trickling filters are usually of the conventional type (Fig. 43.7), and are designed according to surface hydraulic loading rate, since the concentration of suspended solids in the effluent from the TF is relatively low. Table 43.2 lists the surface loading rates recommended for the design of secondary settling tanks after TF.

Depending on the size of the wastewater treatment plant, the secondary settling tanks can have automated or hydraulic pressure sludge removal systems.

(h) BOD removal efficiency in TF

Several theoretical or empirical models are available for the design of trickling filters applied for the treatment of settled wastewater, and these can be found in classical wastewater treatment books. The present chapter includes one of the

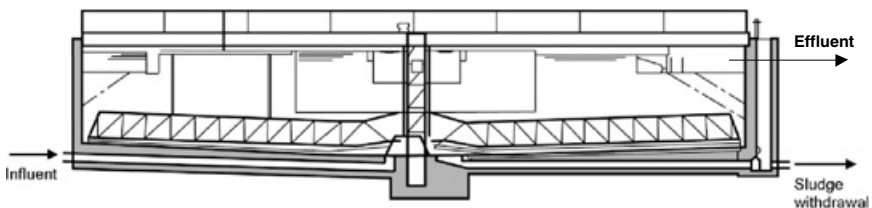

Figure 43.7. Schematics of a secondary settling tank

traditional models, developed by the National Research Council – NRC (USA). The NRC empirical model was developed for filters with stone beds, taking into account operational data obtained in several plants operating in military facilities. The estimation of the BOD removal efficiency from a single filter or the first filter of a double-stage system fed with settled wastewater can be accomplished through Equation 43.3.

$$E = \frac{1}{1 + 0.443\sqrt{\frac{L_v}{F}}} \quad (43.3)$$

where:

E: BOD₅ removal efficiency (%)

L_v: volumetric organic loading rate (kgBOD/m³·d)

F: recirculation factor

The recirculation factor F represents the average number of passes of the influent organic matter through the filter, given by Equation 43.4 (Metcalf and Eddy, 1991). Recycle ratios (R) used vary from 0 to 2.0. When R is equal to zero (which is frequently the case for TFs following UASB reactors), F is equal to 1.0.

$$F = \frac{1 + R}{(1 + R/10)^2} \quad (43.4)$$

where:

R: recycle ratio

In the case of the estimation of the efficiency of trickling filters applied to the post-treatment of effluents from anaerobic reactors, Equation 43.3 should be used with caution, as the information for these applications is still very limited.

(i) Sludge production

The estimation of the sludge production in trickling filters can be made by means of the following equation

$$P_{\text{sludge}} = Y \times \text{BOD}_{\text{rem}} \quad (43.5)$$

where:

P_{sludge}: sludge production, on a dry-solids base (kgTSS/d)

Y: yield coefficient (kgTSS/kgBOD_{removed})

BOD_{rem}: BOD load removed (kgBOD/d)

Values of Y observed in biofilm reactors, operating with high rates and without nitrification, are usually in the range from 0.8 to 1.0 kgTSS/kgBOD_{removed}. The VSS/TSS ratio is in the range from 0.75 to 0.85. This estimate of sludge production has been shown to be adequate for trickling filters applied for the treatment of effluents from UASB reactors. The suspended solids present in the effluent from

Table 43.3. Main design criteria for high rate trickling filters applied to the post-treatment of effluents from anaerobic reactors

Design criterion	Range of values, as a function of the flow		
	for Q_{average}	for $Q_{\text{daily-maximum}}$	for $Q_{\text{hourly-maximum}}$
Packing medium	Stone	Stone	Stone
Depth of the packing bed (m)	2.0 to 3.0	2.0 to 3.0	2.0 to 3.0
Hydraulic loading rate ($\text{m}^3/\text{m}^2 \cdot \text{d}$)	15 to 18	18 to 22	25 to 30
Organic loading rate ($\text{kgBOD}/\text{m}^3 \cdot \text{d}$)	0.5 to 1.0	0.5 to 1.0	0.5 to 1.0

TF are usually removed in conventional secondary settling tanks, as previously mentioned.

Evaluation of the volumetric sludge production is made according to

$$V_{\text{sludge}} = \frac{P_{\text{sludge}}}{\gamma \times C_{\text{sludge}}} \quad (43.6)$$

where:

V_{sludge} : volumetric sludge production (m^3/d)

P_{sludge} : sludge production in TF (kgTSS/d)

γ : density of the sludge (usually in the order of 1,000 to 1,040 kg/m^3)

C_{sludge} : concentration of the sludge removed from the secondary settling tank (usually in the range from 1 to 2%)

(j) Summary of the design criteria for trickling filters used as post-treatment of effluents from UASB reactors

A summary of the main criteria for the design of trickling filters applied to the post-treatment of effluents from anaerobic reactors is presented in Table 43.3.

43.3 CONSTRUCTION ASPECTS

Trickling filters are usually built with reinforced concrete, although smaller units can be made with different materials, such as steel, fibreglass, etc. Great emphasis should be placed on the longevity and integrity of the filter structure and of the packing medium, achieved with the use of appropriately selected materials, resistant to the adverse conditions imposed by the wastewater.

Particular attention should be given to the choice of the packing material and to the filling of the filter, once recurring problems of clogging of the packing medium have been reported. The recommendations contained in Section 43.2-d should be followed, particularly in the case of filters filled with stones, since improper size and shape of the stones can cause failure of the treatment system.

Another important aspect refers to the construction of the bottom drainage system that should be resistant enough to support the whole weight of the structure located in the upper part, including the packing medium, the biofilm and the wastewater. Additionally, the design recommendations regarding the slopes of

the drainage system and the free areas to allow the ventilation of TF should be guaranteed.

43.4 OPERATIONAL ASPECTS

Trickling filters are characterised by their operational simplicity, as the degree of mechanisation of the system is minimum, mainly associated with the flow distribution in the tank and the sludge removal in the secondary settler. The operation of the system consists basically of routine activities, aiming at:

- the monitoring of the efficiency of the treatment system, carried out through an appropriate programme of physical-chemical analyses of the influent and effluent
- the monitoring of the sludge production in the treatment system, accomplished through measurements of suspended solids concentrations in the effluent from the TF and, principally, in the final effluent and in the sludge withdrawn from the secondary sedimentation tank
- the observation of the occurrence of flooding (ponding) on the surface of the TF, that generally occurs when the volume of the void space in the packing medium is occupied by excessive biofilm growth
- the verification of excessive proliferation of flies, usually related to the operation of the TF in an intermittent way and/or to low surface loading rates
- the verification of the bottom drainage system, eliminating any improper accumulation of solids in the lower slab and in the effluent collection gutters

Besides these basic operational items, activities of preventive maintenance should be undertaken, to guarantee the integrity of the treatment units and of all the installed equipment. Special attention should be given to the inspection of the flow distributors and of the sludge scrapers.

Example 43.1

Design a high rate trickling filter for the post-treatment of the effluent from a UASB reactor, given the following data:

Data:

- Population: $P = 20,000$ inhabitants
- Average influent flowrate: $Q_{av} = 3,000 \text{ m}^3/\text{d}$
- Maximum daily influent flowrate: $Q_{\max-d} = 3,600 \text{ m}^3/\text{d}$
- Maximum hourly influent flowrate: $Q_{\max-h} = 5,400 \text{ m}^3/\text{d}$
- Average influent BOD concentration to the UASB reactor:
 $S_{0-UASB} = 350 \text{ mg/L}$

Example 43.1 (Continued)

- BOD removal efficiency expected in the UASB reactor: 70%
- Average influent BOD concentration to the trickling filter:
 $S_{0-TF} = 105 \text{ mg/L}$ (0.105 kg/m^3)
- Desired BOD concentration for the effluent from the TF:
 $S_{e-TF} < 30 \text{ mg/L}$
- Temperature of the wastewater: $T = 23^\circ\text{C}$ (average of the coldest month)
- Yield coefficient (sludge production) in the TF:
 $Y = 0.75 \text{ kgTSS/kgBOD}_{\text{removed}}$
- Expected concentration of the excess sludge wasted from the secondary settling tank: $C = 1.0\%$
- Density of the sludge: $\gamma = 1,020 \text{ kgTSS/m}^3$.

Solution:

(a) *Adoption of the volumetric organic load (L_v)*

From Table 43.3, high rate TFs following anaerobic reactors should be designed with L_v between 0.5 and $1.0 \text{ kgBOD/m}^3 \cdot \text{d}$. Adopted value: $L_v = 0.85 \text{ kgBOD/m}^3 \cdot \text{d}$

(b) *Calculation of the volume of the packing medium (V) (Equation 43.2)*

$$V = (Q_{av} \times S_{0-TF})/L_v$$

$$= (3,000 \text{ m}^3/\text{d} \times 0.105 \text{ kgBOD/m}^3)/(0.85 \text{ kgBOD/m}^3 \cdot \text{d}) = 371 \text{ m}^3$$

(c) *Adoption of the depth of the packing medium*

From Table 43.3, high rate TFs following anaerobic reactors should be designed with packing medium heights between 2.0 and 3.0 m . Adopted value:
 $H = 2.0 \text{ m}$

(d) *Calculation of the TF surface area (A)*

$$A = V/H = (371 \text{ m}^3)/(2.0 \text{ m}) = 186 \text{ m}^2$$

(e) *Verification of the hydraulic loading rate on the TF (L_h) (Equation 43.1)*

For Q average: $L_h = Q_{av}/A = (3,000 \text{ m}^3/\text{d})/(186 \text{ m}^2) = 16.1 \text{ m}^3/\text{m}^2 \cdot \text{d}$

For Q daily maximum: $L_h = Q_{\text{max-d}}/A = (3,600 \text{ m}^3/\text{d})/(186 \text{ m}^2) = 19.3 \text{ m}^3/\text{m}^2 \cdot \text{d}$

For Q hourly maximum: $L_h = Q_{\text{max-h}}/A = (5,400 \text{ m}^3/\text{d})/(186 \text{ m}^2) = 29.0 \text{ m}^3/\text{m}^2 \cdot \text{d}$

It is seen that the values of the hydraulic loading rates are in agreement with the recommended ranges, for the three conditions of applied flows, according to Table 43.3.

Example 43.1 (Continued)*(f) Calculation of the TF diameter (D)*

Adopt two filters, each one with an area of $186 \text{ m}^2/2 = 93 \text{ m}^2$

$$D = [(4 \times A)/\text{PI}]^{0.5} = [(4 \times 93 \text{ m}^2)/(3.1416)]^{0.5} = 10.9 \text{ m}$$

(g) Estimation of the BOD removal efficiency of the TF (Equation 43.3)

For TF following UASB reactors, the effluent recycle ratio may be adopted as zero. Hence, the recirculation factor F is equal to 1.0 (see Equation 43.4)

$$E = 100/[1 + 0.443 \times (L_v/F)^{0.5}] = 100/[1 + 0.443 \times (0.85/1)^{0.5}] = 71\%$$

(h) Estimation of the BOD concentration in the final effluent (Se-TF)

$$S_{e\text{-TF}} = S_{0\text{-TF}} \times (1 - E/100) = 105 \times (1 - 71/100) = 30 \text{ mg/L}$$

(i) Estimation of the sludge production

The expected sludge production in TFs can be estimated from Equations 43.5 and 43.6.

$$P_{\text{sludge}} = Y \times \text{BOD}_{\text{rem}}$$

$$\text{BOD}_{\text{rem}} = Q_{\text{av}} \times (S_{0\text{-TF}} - S_{e\text{-TF}}) = 3,000 \text{ m}^3/\text{d} \times (0.105 \text{ kgBOD}/\text{m}^3 - 0.030 \text{ kgBOD}/\text{m}^3)$$

$$\text{BOD}_{\text{rem}} = 225 \text{ kgBOD}_{\text{rem}}/\text{d}$$

$$P_{\text{sludge}} = 0.75 \text{ kgTSS}/\text{kgBOD}_{\text{rem}} \times 225 \text{ kgBOD}_{\text{rem}}/\text{d} = 169 \text{ kgTSS}/\text{d}$$

Considering 75% of volatile solids:

$$P_{\text{sludge-volatile}} = 0.75 \times 169 \text{ kgTSS}/\text{d} = 127 \text{ kgVSS}/\text{d}$$

The volumetric sludge production is (Equation 43.6):

$$\begin{aligned} V_{\text{sludge}} &= P_{\text{sludge}}/(\gamma \times C_{\text{sludge}}) \\ &= (169 \text{ kgTSS}/\text{d})/(1,020 \text{ kg}/\text{m}^3 \times 0.01) = 17 \text{ m}^3/\text{d} \end{aligned}$$

(j) Design of the secondary settling tank

From Table 43.2, the settling tanks should be designed with surface hydraulic loading rates between 16 and 32 $\text{m}^3/\text{m}^2 \cdot \text{d}$. Adopted value: $L_h = 24 \text{ m}^3/\text{m}^2 \cdot \text{d}$

$$A = Q_{\text{av}}/L_h = (3,000 \text{ m}^3/\text{d})/(24 \text{ m}^3/\text{m}^2 \cdot \text{d}) = 125 \text{ m}^2$$

Adopt two circular settling tanks with peripheral traction sludge scrapers, as follows:

Diameter = 9.0 m; useful side-wall depth = 3.5 m; surface area, per unit = 63.5 m^2

Example 43.1 (Continued)

According to Table 43.2, the maximum hydraulic loading rate should be between 40 and 48 m³/m²·d, and the calculated value is:

$$L_h = Q_{\max-h}/A = (5,400 \text{ m}^3/\text{d})/(2 \times 63.5 \text{ m}^2) = 43 \text{ m}^3/\text{m}^2 \cdot \text{d}$$

(k) Sludge processing

- Sludge production in the UASB reactors

$$\begin{aligned} P_{\text{sludge}} &= Y \times \text{BOD}_{\text{applied}} \\ &= 0.28 \text{ kgTSS/kgBOD}_{\text{applied}} \times 3.000 \text{ m}^3/\text{d} \times 0.350 \text{ kgBOD/m}^3 \\ &= 294 \text{ kgTSS/d} \end{aligned}$$

- Total sludge production to be discharged, including the secondary aerobic sludge returned to the UASB reactors, considering 30% reduction of the aerobic sludge (VSS) in the UASB reactor:

$$P_{\text{sludge}} = 294 + (169 - 0.30 \times 127) = 425 \text{ kgTSS/d}$$

44

Rotating biological contactors

R.F. Gonçalves

44.1 INTRODUCTION

The first commercial rotating biological contactor (RBC) was installed in Germany in 1960. The development of this process was induced by the interest in the use of plastic mediums, and it initially presented a series of advantages when compared to the classic low-rate trickling filters with stone beds.

In the 1970s, its application was expanded, due to the development of new support mediums and to the low energy requirements, when compared to the activated sludge process. Due to structural problems with shafts and support mediums, excessive growth of the attached biomass, irregular rotations and other problems of low process performance, a certain rejection of this process occurred in subsequent decades. However, progresses in technological research and new support medium systems made its application viable in certain situations, such as in small systems. In spite of the simplicity and operational stability, this process is not frequently used in developing countries. However, in the last few years, treatment plants associating UASB reactors and rotating biological contactors have become an option for the treatment of sewage from small and medium urban areas.

44.2 DESCRIPTION OF THE TECHNOLOGY

A rotating biological contactor consists of a prismatic tank, where horizontal shafts with equally-spaced coupled discs are installed. The shafts are maintained at

constant rotation (1 to 2 rpm), either by mechanical action (when working with about 40% of the diameter submerged) or by air impulsion (when working with about 90% of its diameter submerged). This rotation movement first exposes the discs to the atmospheric air and then to the organic matter contained in the liquid medium. This facilitates the attachment and growth of the microorganisms onto the surface, forming a few-millimetres-thick film that covers the whole disc.

The discs are generally circular and built of low-density plastic, being installed in such a way as to be partially immersed, usually around 40%. Their main roles are:

- serve as a support medium for the development of the biofilm
- promote the contact of the biofilm with the wastewater
- maintain the excess biomass dislodged from the discs in suspension in the wastewater
- promote the aeration of the biofilm and the wastewater attached to it in the inferior part, due to the immersion of the discs

There are cases in which the discs work about 90% submerged, and in these cases introduction of air is necessary to allow enough oxygen for the aerobic process. When the biofilm reaches an excessive thickness, part of it detaches, and the organisms are maintained in suspension in the liquid medium due to the movement of the discs, increasing the efficiency of the system. However, the detached biomass and other suspended solids leave with the effluent, requiring a secondary settling tank for the removal of these solids. Well-designed biodiscs can reach secondary level treatment with respect to nitrification and denitrification.

Figure 44.1 presents a typical flowsheet of a treatment plant that uses rotating biological contactors. The primary settling tank can be substituted by a UASB reactor, substantially decreasing the organic load in the aerobic stage.

Mass transfer and substrate and oxygen diffusion, amongst several aspects, control organic matter removal in rotating biological contactors. However, due to the complexity of the transfer/diffusion phenomenon, there is no simplified model for simulating the removal of organic matter. The maximum organic matter removal rates are limited by the oxygen transfer capacity. The main source of oxygen for the system is the atmospheric air; the turbulence generated by the rotation of the discs is only an additional beneficial consequence.

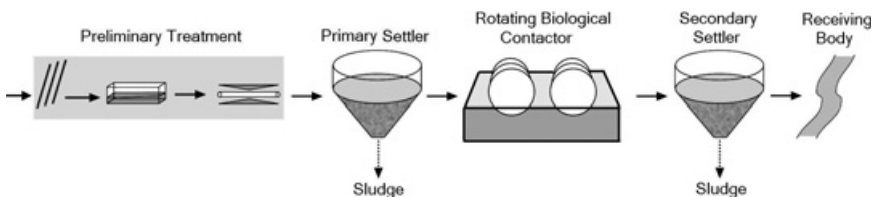

Figure 44.1. Typical flowsheet of a treatment plant with rotating biological contactors

44.3 DESIGN CRITERIA

Rotating biological contactors are more frequently used for the treatment of settled domestic sewage, although some installations for the post-treatment of effluents from UASB reactors are already in operation. RBC units are usually designed to reach only BOD and SS removal, or to obtain a well-nitrified effluent.

(a) Hydraulic and organic loading rates

A sufficient residence or reaction time is necessary in any biological reactor. Therefore, a flow increment results in the increase in the hydraulic loading rate and a decrease in the detention time. Flow equalisation could be considered when peak daily flows are 2.5 times greater than the average flow.

To take advantage of the biological reaction rates, that are higher with larger concentrations of soluble BOD in the liquid undergoing treatment, it is usual to divide the unit into stages, operating the first stage with soluble BOD ≥ 50 mg/L, to approach zero-order reaction in relation to BOD, with a maximum removal rate of about 12 gBOD/m²·day. However, the organic loading rate in the first stage is also a limiting variable for the design, due to problems with excessive loading rates leading to increases in the biofilm thickness, limitations with relation to oxygen availability, odour generation, process deterioration, structural overload, etc. In view of these observations, for settled domestic sewage, the maximum organic loading rate suggested for the first stage has been limited by some equipment manufacturers at 15 gBOD_{soluble}/m²·day, or 30 gBOD/m²·day. Metcalf and Eddy (1991) suggest maximum values from 20 to 30 gBOD_{soluble}/m²·day, or 40 to 60 gBOD/m²·day.

In general, rotating biological contactors have a minimum of two stages for secondary level treatment and three stages for BOD removal and nitrification. The organic loading rate based on soluble BOD is considered important, since the biodegradable organic matter predominantly used by the biomass attached to the disc is soluble, which is more quickly biodegraded and, therefore, the one that controls the maximum oxygen uptake rates. For settled domestic sewage there is about 50% of soluble BOD and the other 50% in suspension. For effluents from UASB reactors, the available data of the BOD_{filtered}/BOD_{total} ratio are limited, indicating a ratio varying from 0.4 to 0.5, while the COD_{filtered}/COD_{total} ratio is more commonly in the range from 0.4 to 0.7.

Observations on substrate concentration and hydraulic loading rate lead to the verification of the influence of these parameters in the substrate removal rate and in the efficiency of the system, converging in the concept of total organic load, as a parameter for design purposes (WEF, 1992). In an investigation of 23 treatment plants with rotating biological contactors in the USA, a curve of influent BOD₅ versus hydraulic load was adjusted for the first stage (Figure 44.2). Above the curve, process performance was hindered. The curve corresponds to the limit of 31 gBOD₅/m²·d for the development of sulphur-oxidiser organisms. With the application of high organic loading rates, the following problems can occur: development of a heavier

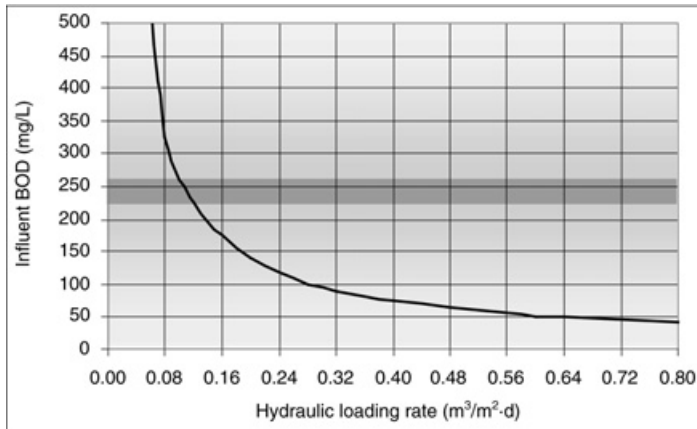

Figure 44.2. Relationship between influent organic matter concentration and hydraulic loading rate in RBC units (adapted from WEF, 1992)

biofilm, growth of harmful organisms, DO reduction and a total deterioration of the process performance.

(b) Characteristics of the influent wastewater

The characteristics of the influent wastewater and the impact on the biodegradability are important considerations in the design of rotating biological contactors. High concentrations of H_2S accelerate the growth of organisms that are harmful to the process. In influents with high H_2S concentration, removal systems should be included upstream, such as pre-aeration.

(c) Temperature of the wastewater

Literature indicates that the efficiency of the process is not affected by temperatures of the wastewater above 13 °C. However, as in every biological process, there is a reduction in the process performance for lower temperatures.

(d) Control of the biofilm

Biofilm thickness is very important for rotating biological contactors, either expressed in terms of total thickness or active thickness. Depending on the hydrodynamic conditions, the total thickness of the biofilm varies between 0.07 and 4.0 mm. However, from studies that relate biofilm thickness with removal efficiency, the part of the biofilm that contributes to the substrate removal, called the active biofilm thickness, was estimated between 20 and 600 μm . Most of these studies showed that, due to limitations of oxygen or substrate diffusion, there is a maximum active biofilm thickness, above which the removal rate does not increase.

Sufficient operational flexibility should be included for the control of the biofilm thickness. Due to the application of a larger organic loading rate in the first stages,

they can have a larger biofilm growth. Devices to measure the weight of the shaft can be applied to control the growth and accumulation of the biomass. Techniques for biofilm thickness control include increases in the rotation speed (shearing forces), periodic reversal of the rotation direction, use of supplementary aeration, use of removable baffles and step-feeding for the reduction of the organic loading rate, or, as a last resort, use of chemical products for the removal of the biofilm.

(e) Dissolved oxygen levels

One of the most frequent causes of aerobic system failure is inadequate level of dissolved oxygen. Literature indicates a minimum DO level of 2 mg/L for rotating biological contactors. Low DO levels for high-rate systems lead to the production of H₂S inside the biofilm, which increases the growth of sulphur-oxidiser organisms such as *Beggiatoa* (filamentous bacteria), generating excess biomass, weight increase and a possible failure of the shafts or support medium (Metcalf and Eddy, 1991). These microorganisms compete with the heterotrophic organisms for consumption of the available oxygen and for space in the support medium, generating an increase in the biofilm thickness and a reduction in the organic matter removal efficiency.

Nitrifying organisms are more sensitive to dissolved oxygen levels than heterotrophic organisms. The DO levels necessary for nitrification vary from 0.5 to 4.0 mg/L, 2.0 mg/L being a typical value. In systems applied for nitrification, the DO level generally rises in the later stages. Combined with low BOD₅ values, this can reduce the nitrification efficiency, due to the development of protozoan predators of the nitrifying bacteria. To avoid the growth of predators, a maximum DO level of 3.5 mg/L and BOD_{filtered} between 6 and 8 mg/L is suggested in the nitrification stages. The design should include ways of increasing the DO in the system, such as velocity variation control, supplementary aeration, recirculation of the effluent, step-feeding of the influent and the use of removable baffles, mainly in the initial stages.

(f) Operational flexibility

Rotating biological contactors should be provided with adequate flexibility for good operation and maintenance. The following items should be observed:

- possibility of supplementary aeration in mechanical rotation systems, aiming at counteracting possible overloads in the first stages
- means for the removal of the excess biofilm, such as air stripping, water or chemical additives, rotation control, etc
- removable baffles between all the stages
- feeding alternatives of the reactor
- recirculation of effluent from secondary clarifier
- DO monitoring in the stages
- easy access to equipment that need inspection, maintenance and replacement, such as shafts, support material, blowers, etc
- drainage of the tanks

Table 44.1. Summary of the design criteria for rotating biological contactors

Item	Treatment objective		
	BOD removal	BOD removal and nitrification	Separate nitrification
Hydraulic loading rate ($\text{m}^3/\text{m}^2 \cdot \text{day}$)	0.08 to 0.16	0.03 to 0.08	0.04 to 0.10
Surface organic loading rate (SOLR) ($\text{gBOD}_{\text{soluble}}/\text{m}^2 \cdot \text{day}$)	3.7 to 9.8	2.4 to 7.3	0.5 to 1.5
Surface organic loading rate (SOLR) ($\text{gBOD}/\text{m}^2 \cdot \text{day}$)	9.8 to 17.2	7.3 to 14.6	1.0 to 2.9
Maximum SOLR in first stage ($\text{gBOD}_{\text{soluble}}/\text{m}^2 \cdot \text{day}$)	19 to 29 (14*)	19 to 29 (14*)	–
Maximum SOLR in first stage ($\text{gBOD}/\text{m}^2 \cdot \text{day}$)	39 to 59 (30*)	39 to 59 (30*)	–
Surface nitrogen loading rate ($\text{g N-NH}_4^+/\text{m}^2 \cdot \text{day}$)	–	0.7 to 1.5	1.0 to 2.0
Hydraulic detention time (hour)	0.7 to 1.5	1.5 to 4.0	1.2 to 2.9
BOD in the effluent (mg/L)	15 to 30	7 to 15	7 to 15
N-NH_4^+ in the effluent (mg/L)	–	<2	<2

* Typical design values

Source: Adapted from Metcalf and Eddy (1991)

(g) Sludge production and characteristics

The production and characteristics of the sludge generated in rotating biological contactors are basically the same as those from trickling filters, around 0.75 to 1.0 $\text{kgTSS}/\text{kgBOD}_{\text{removed}}$, with a VSS/TSS ratio of 0.75 to 0.85. Equations 43.5 and 43.6 can be used in the dimensioning of the sludge treatment units.

(h) Summary of the design criteria

The recommendations for the design of rotating biological contactors are mainly based on the BOD loading rate per unit area of support material, and also on the hydraulic loading rate per surface area available for biofilm growth. Table 44.1, adapted from Metcalf and Eddy (1991), can be used for design purposes.

44.4 CONSTRUCTION ASPECTS AND CHARACTERISTICS OF THE SUPPORT MEDIUM

The biodiscs have a shaft which supports and rotates the plastic medium that serves as support for the development of the biofilm. For high-density polythene biodiscs, the shaft length varies from 1.5 to 8.0 m and the diameter from 2.0 to 3.8 m. There are several types of corrugated surfaces (Metcalf and Eddy, 1991):

- low density (or conventional), with about 9,300 m^2 per unit, with a shaft length in the order of 8.0 m and a diameter of 3.8 m
- average or high density, with areas of about 11,000 to 16,700 m^2 per unit, with the same dimensions as previously referred

The low-density units are usually used in the first stages, while the average and high density ones are applied in the final stages of the system. The reason is that in the initial stages, with higher BOD concentrations, there is a larger biomass growth, which could lead to an excessive weight of the high-density units, harming its structure.

Some discs are composed of cylinders, with their interior made up of a beehive-type structure, with the objective of having high specific surface areas. A variant of the discs is composed of wheels with corrugated tubes that work with an immersion of about 90%, rotating and allowing the liquid to enter inside the tubes, dragging large amounts of air. The movement of the wheels is induced by the application of air that is also used to complement the oxygen requirements for the aerobic process. These wheels have a diameter varying from 1.2 to 3.3 m, with a surface area that varies from 170 m², for a wheel with a diameter of 1.2 m and a width of 0.9 m, to 4.000 m², for a wheel with a diameter of 3.3 m and a width of 2.5 m.

For discs that work with an immersion of about 40% of its diameter, it is common for the systems to be covered, to protect them against deterioration by ultraviolet radiation and also to avoid algal growth, that can lead to a substantial increase in the weight of the biomass attached to the surface of the discs.

Submerged aerated biofilters

R.F. Gonçalves

45.1 INTRODUCTION

Submerged aerated biofilters are nowadays a mature technology, being present at compact treatment plants that can even be buried in the sub-soil of sporting stadiums, parks and buildings in the middle of an urban area. One of the main advantages of the technology is the low environmental impact, especially when covered and deodorised, which can be done with relative simplicity (Rogalla *et al.*, 1992). Other advantages are the compactness, modular aspect, fast start-up, resistance to shock loads, absence of secondary clarification (Pujol *et al.*, 1992) and resistance to low wastewater temperatures (Gonçalves and Rogalla, 1994).

Biofilters are capable of reaching different quality objectives: oxidation of organic matter (Pujol *et al.*, 1992), secondary or tertiary nitrification (Carrand *et al.*, 1990; Tschui *et al.*, 1993), denitrification (Lacamp *et al.*, 1992), and physical-chemical phosphate removal (Gonçalves *et al.*, 1992). In warm-climate areas, biofilters can be used for the post-treatment of effluents from UASB reactors aiming at the removal of organic matter.

45.2 DESCRIPTION OF THE TECHNOLOGY

45.2.1 General aspects

In practice, a submerged aerated biofilter is constituted by a tank filled with a porous material through which wastewater and air permanently flow. In almost all

of the existent processes, the porous medium is maintained under total immersion by the hydraulic flow, constituting tri-phase reactors composed of:

- *solid phase*: constituted by the support medium and by the colonies of microorganisms that develop in the form of a biofilm
- *liquid phase*: composed of the liquid in permanent movement through the porous medium
- *gas phase*: formed by the artificial aeration and in a reduced scale by the gaseous by-products of the biological activity

Submerged aerated biofilters (SAB) with *granular mediums* accomplish in the same reactor the removal of soluble organic compounds and suspended particles present in the wastewater. Besides serving as a support medium for the microorganisms, the granular material constitutes an effective filtering medium. In this process, periodical washings are necessary to eliminate the excess of accumulated biomass, reducing the hydraulic head losses through the medium. During washing, with or without interruption of wastewater feeding, several hydraulic discharge sequences of air and wash water are carried out.

On the other hand, the submerged biofilters with *structured beds*, also called *submerged aerated filters (SAF)*, are classified by the same type of packing medium used for trickling filters (TF). Since they do not have granular-type packing material, as in SAB, they do not retain the suspended biomass by the filtration action, thus needing secondary settling tanks, at least for the usual hydraulic loading rates applied to trickling filters. SAF can operate with upward or downward flow and, as they need air supply for aeration, this is done through coarse bubble diffusers placed in the lower part of the filter, fed by blowers. Feeding of SAF is similar to that of SAB. When operated without sludge recirculation, they respond in a similar way to trickling filters (even though TF could be operating with final effluent recycle to dilute the influent to about 100 mg BOD/L) submitted to the same organic loading rates per unit area or unit volume of the packing medium.

The first SAB appeared at the beginning of the 1980s and were conceived for the removal of SS and the oxidation of organic matter from domestic sewage. A typical flowsheet of such a treatment plant is presented in Figure 45.1.

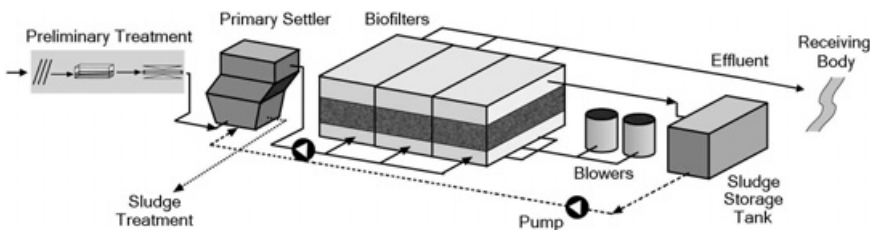

Figure 45.1. Typical flowsheet of a treatment plant with SAB with granular medium for BOD and SS removal (Gonçalves, 1993)

Its main components are:

- *pre-treatment*: coarse screening, fine screening and grit removal
- *primary treatment*: conventional or lamellar settling tanks
- *secondary treatment*: SAB, in this case, with upward flow

The two sources of sludge generation are the primary sedimentation tanks and the washing of SAB. The wash sludge is generally retained in a storage tank, and is pumped for clarification in the primary settling tank, outside the peak flow hours. Therefore, the sludge to be treated is a mixed one, composed of primary and biological sludge.

To limit fast clogging of SAB with granular filter bed, it is imperative to have a primary sedimentation stage in the treatment of domestic sewage. The complete elimination of primary treatment is only possible in the case of very diluted wastewater, and even so with a very efficient pre-treatment ($SS < 120 \text{ mg/L}$).

45.2.2 Treatment plants associating UASB reactors and SAB

A configuration of a treatment plant associating UASB reactors and SAB in series was developed by Gonçalves *et al.* (1994). The proposed configuration substitutes the primary sedimentation tanks by UASB reactors, which remove about 70% of the influent BOD (Figure 45.2). Post-treatment of the anaerobic effluent is accomplished in the submerged aerated biofilters, aiming at the removal of organic matter and the remaining suspended solids.

In parallel with the development of this configuration, a series of simplifications were introduced in the biofilters, compared with similar European processes. Three types of low cost, widely available commercial gravels or broken stones (grades 2, 1 and 0) are used in the composition of the packing mediums of the biofilters. The aeration system comprises Venturi tubes through which a pump sucks the aerobic effluent, captures air near the orifices, and injects water and dissolved air in the base of the biofilters. The air is captured in the vicinity of the main emission points of malodorous compounds (grit chamber, pumping station, drying bed) and is reintroduced into SAB, where biological odour removal occurs, with approximately 95% H_2S removal (Matos *et al.*, 2001). SAB units are interconnected

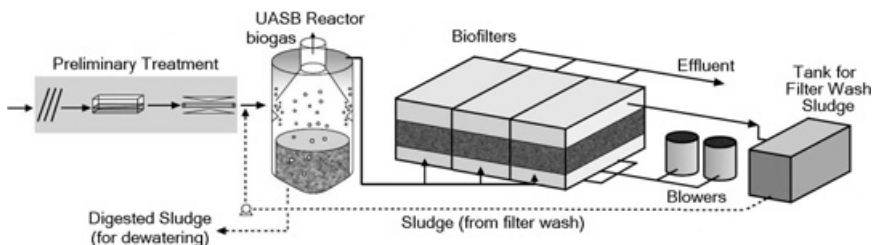

Figure 45.2. Typical flowsheet of a treatment plant associating a UASB reactor and SAB in series

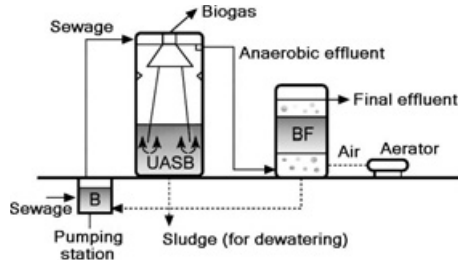

Figure 45.3. Arrangement of a treatment plant comprising UASB + SAB

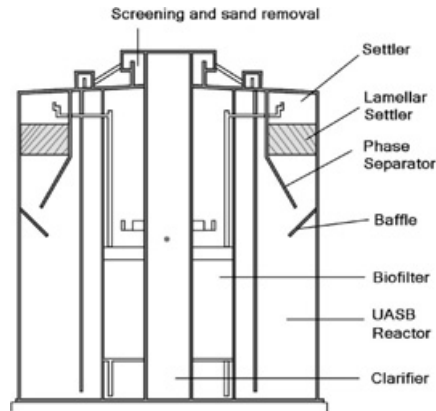

Figure 45.4. Schematics of a compact plant with UASB + SAB in the same volume (courtesy: Sanevix Engenharia Ltda)

in their upper part, allowing the use of treated effluent in the washing operation, which is accomplished in downflow mode without air injection.

In the proposed system, the excess sludge produced in the biofilters is recirculated to the UASB reactor, where thickening and anaerobic digestion occur. The excess sludge produced in the UASB reactor is highly concentrated and stabilised, being discharged by gravity to the dewatering unit. The UASB reactors and SAB units can be built separately (Figure 45.3) or in the same volume (Figure 45.4).

45.2.3 Important aspects of the technology

(a) Flow direction (air and water)

The flow direction (air and water) determines the main operational characteristics of a submerged aerated biofilter and directly influences the following points: SS retention, gas–liquid transfer, development of the hydraulic head loss, washing type, energy utilisation and odour production. The different options for the flow direction are presented in Figure 45.5 (Richard and Cyr, 1990). The air flow in SAB

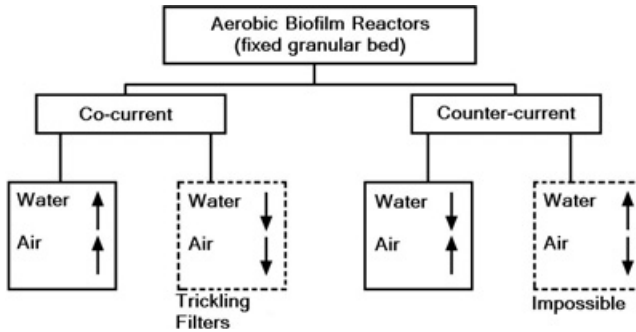

Figure 45.5. Flow directions (air/liquid) in biofilm aerobic reactors (Richard and Cyr, 1990)

is only viable in an upflow direction, due to the state of permanent immersion of the packing medium. A downflow air current is only possible in granular mediums that are not submerged (as in the case of trickling filters), which limits the options for the flow in SAB to two possibilities:

- *co-current*: with upward liquid and air flows
- *counter-current*: with downward liquid and upward air flows

The different processes are generally classified based on the flow direction: upward or downward. The main advantages and disadvantages of each one of these options are as follows:

- *solids retention capacity*: the SS retention capacity is larger in downflow processes with heavy granular mediums (density > 1) or upflow with a floating medium (density < 1). In this case, the liquid flow proceeds in the direction of the compression of the filter bed, conferring its large filtration capacity. On the other hand, in the upflow processes with heavy packing medium, the co-current flow produces an expansion of the filter bed, which allows a better-distributed SS retention along the SAB height. SAB units with structured packing medium need secondary settling, because they possess small SS capture and storage capacity.
- *evolution of the head loss*: due to the high efficiency in SS retention, the head loss develops more quickly in downflow SAB with heavy granular beds and in upflow SAB with a floating medium. With a relatively slower head loss evolution, the upflow processes with heavy material have beds with a height that could reach up to 3.00 m. The evolution of the head loss is extremely low in structured packing mediums (honeycomb-type), with a filtration cycle that could last several days.
- *hydraulic behaviour*: the downflow processes (counter-current) can favour the formation of air bubbles trapped in the middle of the granular medium (embolism). A disadvantage of the upflow processes is the possibility of a deficient influent distribution in the granular medium, generating short circuits and reduction of efficiency.

- *aeration demand*: manufacturers state that downflow processes require less air and that the head loss is smaller, due to the relatively small height of the filter bed (Sibony, 1983). Manufacturers of upflow processes claim that, due to the larger filter bed height, the oxygen transfer efficiency is very high – from 23 to 30% (Strohmeir *et al.*, 1993). Experimental data obtained in full-scale plants indicate that this efficiency reaches, at the most, 10% in the two process types (Canler and Perret, 1993).
- *construction details*: in the downflow processes, the aeration tubing only enters in contact with the treated wastewater, and is less subject to blockages by solids present in the settled wastewater. In the case of the upflow processes, only the treated wastewater enters in contact with the atmosphere, eliminating odour problems. Upflow SAB can also be self-cleaning, when the washing is carried out in the counter-current mode.

(b) Packing material

The packing medium should accomplish two functions in SAB: to serve as a support for the attachment of the microorganisms and to physically retain SS present in the wastewater. The smaller the specific surface available for the attachment of the microorganism colonies, the smaller the SS retention capacity by filtration will be. On the other hand, materials with high specific surfaces favour fast evolution of the head loss, demanding more frequent washings of the SAB.

The choice of the characteristics of the packing medium is a compromise between quality of the treated effluent and washing frequency, within reasonable economical limits. The most commonly used packing mediums are composed of granular material with the following main characteristics:

- Grain size between 2 and 6 mm, in the case of domestic sewage treatment in downflow SAB (Gilles, 1990). Grains with an effective diameter between 1 and 2 mm are appropriate for tertiary nitrification in upflow SAB, while for carbonaceous oxidation the diameter should be larger than 2.5 mm (Richard and Cyr, 1990). In Brazil, SAB units with packing medium composed of gravel layers (grades 4, 2 and 0) have been used with success (Bof *et al.*, 2001). The introduction of sand layers significantly increases the clarification of the treated effluent. Amongst the granular materials, the more commonly used have a specific surface varying between 200 and 600 m²/m³.
- Density in the order of 1.5, for the case of granular materials applied to secondary treatment. Higher densities imply greater energy consumption with the expansion of the bed during washing. In the case of the packing material of the BIOSTYR process (OTV, France), polystyrene beads (density = 0.04) with specific surface greater than 1,000 m²/m³ are used. Denser materials, such as gravel or broken stones, can be used for the post-treatment of anaerobic effluents when the average specific surface of the filter bed does not exceed 300 m²/m³.
- Homogeneous grain size to avoid clogging of the void spaces by smaller particles. When using stratified beds in secondary treatment, different densities should be adopted among the layers of different materials.

- Inert, non-biodegradable and non-deforming material, so that the packing medium conserves its shape and grain size characteristics during several years of plant operation.
- Resistance to abrasion, resulting from the turbulence produced during washing of the granular medium.

The shape of the grains does not significantly influence the performance of the process. The surface characteristics that facilitate the attachment of the biomass are more important, mainly specific surface and roughness.

Granular materials of mineral origin are currently more commonly used in treatment plants. Grains of calcined clay or expanded schistus of the silicate family are the most common in Europe. Sandy materials, pozzolana and activated carbon are used less frequently. Some of these materials are patented, notably some calcined clays that receive a surface treatment with metallic salts or activated carbon. The first SAB units used in Brazil were packed with broken stone or gravel and expanded clay. However, as a result of the high cost of the expanded clay, new SAB units are packed almost exclusively with broken stone or gravel. Sandy layers of different granulometry have also been tested, aiming at the production of a highly clarified effluent.

On the other hand, the use of synthetic materials was intensified at the beginning of the 1990s and generated new processes with floating or structured medium (submerged aerated filters, – SAF). Granular mediums with a specific weight varying between 0.03 and 0.9 g/cm³ have been used, composed of materials such as polystyrene, polypropylene, polyurethane, PVC and plastic. The price of these materials is higher than those of a mineral origin, although a part of the additional cost can be compensated by the smaller energy demand during washing. In most European SAB units, elimination of the wash water reservoirs (self-cleaning SAB) can be achieved with the use of synthetic materials. Some of the synthetic granular materials used in SAB have a porosity of 40% and specific surfaces greater than 1,000 m²/m³ (Tschui *et al.*, 1993).

Structured synthetic materials comprise corrugated mediums with a honeycomb or similar type, and present specific surfaces varying between 100 and 500 m²/m³ and porosity higher than 80%. The result of this high porosity is a smaller filtration capacity and the need for SAB units to have complementary clarification of the treated effluent. In contrast, this type of SAB presents the following advantages in relation to other SAB units: liquid velocities of up to 20 m/hour, filtration cycles of up to 1 week and the absence of hydraulic short circuits (Gros and Karl, 1993).

(c) Aeration system – oxygen demand

Most SAB and SAF units have a direct system of artificial aeration, composed of blowers and air pipes. In older SAB units with heavy granular mediums, the aeration grid is located at the base of the filter bed, supported on the slab with diffusers. In upflow processes, the grid can be introduced inside the granular medium, allowing the creation of a non-aerated fraction at the beginning of the filter bed.

In rare cases of extremely diluted effluent, the aeration can be accomplished outside the SAB. In anoxic SAB used as denitrification reactors in wastewater treatment (Jepsen *et al.*, 1992) or in water treatment (Ravarini *et al.*, 1988), the air injection device is also non-existent. In these last two cases, the SAB operates predominantly as a two-phase reactor, in more favourable hydraulic conditions than in the case of a three-phase SAB. Tests using pure oxygen in the treatment of domestic sewage did not produce results that justified the cost increment.

(d) Washing of the filter medium

Periodic washing of the filter medium is an obligatory stage in the operation of SAB, to control the progressive clogging of the bed due to biofilm growth (microorganisms and retained SS). The duration of these cycles depends on the granulometry of the material, the applied load, the characteristics of the wastewater and the nature of the attached biomass. Most SAB units applied to secondary wastewater treatment are designed to operate for 24 to 48 hour periods between two consecutive washings.

The amount of treated water used and the energy consumption (pumps and air) are two factors to be considered in the definition of the washing procedure. The volume of wash water used in SAB with fixed granular beds is estimated, in upflow SAB, as 3 to 8% of the treated volume (Strohmeier and Schroeter, 1993) and from 5 to 10%, in downflow SAB (Upton and Stephenson, 1993). According to Pujol *et al.* (1992), the volume of water necessary to wash a SAB can be estimated as three times the filter bed volume. In the case of the association of UASB reactors with SAB, the washing can be done every 3 days, using less than 2% of the treated wastewater volume in the period between two washes.

The main manufacturers of SAB with heavy granular materials adopt washing protocols with different times, but with identical sequence of objectives, as detailed in Section 45.5. The various existing washing protocols were conceived so that the operation lasts for 20 to 40 minutes. In the case of European treatment plants, the excess sludge is pumped to the primary settling tank for combined treatment with the primary sludge.

(e) Energy consumption

The consumption of energy in the biofilters is concentrated on aeration, on the supply of air for washing and on the pumping of wash water (Table 45.1). Evaluation campaigns carried out in French treatment plants showed that the highest energy consumption is due to aeration, which consumes on average 87% of the energy related to secondary treatment (Canler and Perret, 1993). The energy balance undertaken by Kleiber *et al.* (1993) in the Perpignan treatment plant (France), covering a period of 12 months, resulted in the following consumption distribution in the secondary treatment: air-process = 83% of the total consumption, SAB washings = 17%.

Regulation devices of air supply as a function of the influent load are non-existent in most treatment plants in operation, which leads to energy consumptions

Table 45.1. Energy consumption in several treatment plants with granular SAB

Energy demand (kWh/kg removed)		Type of SAB	Treatment level	Observation	Reference
COD	BOD ₅				
0.94		Upflow	Secondary	Overall consumption	Gilles (1990)
1.05				Consumption in the SAB	
1.30		Upflow	Secondary	BIOFOR	Partos <i>et al.</i> (1985)
1.02 to 1.25		Upflow/ downflow	Secondary	Study in 12 plants	Canler and Perret (1993)
	1.41	Downflow	Secondary with nitrification	Air for the process	Condren (1990)
	1.98			Overall consumption in SAB	
0.40		Upflow	UASB + SAB	Plants in Brazil	Bof <i>et al.</i> (2001)

that do not correspond to the real process needs. Some energy consumption values published by several authors are summarised in Table 45.1.

In the study carried out by CEMAGREF in 12 French treatment plants, installed power per unit volume of granular bed was on average $1,430 \text{ W/m}^3$ for upflow SAB (Pujol *et al.*, 1992). This power was split into 130 W/m^3 for process aeration, 600 W/m^3 for wash aeration and 700 W/m^3 for wash pumps. For downflow SAB, the installed power was on average $1,250 \text{ W/m}^3$, divided into 300 W/m^3 for process aeration, 650 W/m^3 for wash aeration and 300 W/m^3 for wash pumps.

Treatment plants associating UASB reactor + SAB in operation in Brazil present an average power of 2.0 W/inhabitant . Of this value, 50% correspond to the energy consumption in the aeration of the SAB. The other half refers to lighting and wastewater and sludge pumps. In terms of organic matter removal, the average energy consumption is $0.4 \text{ kWh/kgCOD}_{\text{removed}}$. In comparison with other data from Table 45.1, this value shows the importance of the anaerobic treatment upstream the SAB in the reduction of the energy consumption in the treatment plant.

45.3 DESIGN CRITERIA

(a) Preliminary considerations

The design of SAB and SAF is basically accomplished using empirical data, obtained through pilot- or full-scale experiments. The main design parameters are very similar to those already described in Section 43.2, related to trickling filters:

- *hydraulic loading rate*: volume of wastewater applied daily per unit area of the packing medium of the biofilter, expressed in $\text{m}^3/\text{m}^2 \cdot \text{d}$ (Equation 43.1)
- *organic loading rate*: mass of organic matter applied daily to the biofilter, per unit volume of the packing medium, expressed in $\text{kgBOD}/\text{m}^3 \cdot \text{d}$ or $\text{kgCOD}/\text{m}^3 \cdot \text{d}$ (Equation 43.2)

(b) Sludge production and characteristics

The specific sludge production in secondary treatment in upflow or downflow SAB units is of the order of **0.4 kgTSS/kgCOD_{removed}** or **0.8 to 1.0 kgTSS/kgBOD₅removed** (Pujol *et al.*, 1992; Richard and Cyr, 1990). The excess sludge removed through washing of the bed can be estimated as 1 kg TSS/m³ of the bed. Due to the fact that, besides biofilm growth, washing also removes SS retained by filtration, the wash sludge contains large amounts of volatile solids (>80%). Its settleability and thickening ability are relatively good.

In the case of the association of UASB reactor + SAB, the sludge production in SAB submitted to organic loading rates lower than 3.5 kgCOD/m³bed·d is estimated as **0.25 kgTSS/kgCOD_{removed}**. In these cases, a large fraction of the rapidly biodegradable COD is removed in the anaerobic treatment stage, which allows the development of a thin biofilm with a very high sludge age inside the SAB. Volatile solids levels lower than 60% (VS/TS) are observed in the sludge discharged from SAB operating under such conditions. When the organic loading rate exceeds 4.0 kgCOD/m³·d, the sludge production and characteristics resemble those described for secondary treatment.

The sludge production estimated for SAF and the design of the secondary settling tanks after SAF are identical to those described for trickling filters (Section 43.2). Considering that trickling filters lead to high head losses in the hydraulic profile of the treatment plant, SAF becomes a very attractive alternative for biological post-treatment of effluents from UASB reactors when the area available for the treatment plant is flat.

Additionally, this type of filter, when packed with material with high porosity and high specific surface area, can allow a good recirculation of sludge from the secondary settling tank, significantly increasing the biomass in the system. This configuration allows a greater organic matter removal potential per unit volume and also nitrification. However, this conception implies the use of a reactor with possible predominance of biomass in suspension, discussion of which is beyond the scope of this chapter.

(c) Aeration rates

Some values of the aeration rates practised in secondary treatment in granular SAB are presented in Table 45.2. Manufacturers of SAB with granular mediums state that oxygen transfer can reach efficiencies from 20 to 25%. However, rigorous monitoring campaigns carried out by a technical department of the French Ministry of Agriculture (CEMAGREF) showed that in full-scale treatment plants

Table 45.2. Aeration rates for secondary treatment in upflow and downflow SAB units

Aeration rate (Nm ³ /kg applied)		Type of SAB	Observation	Level of treatment	Reference
COD	BOD ₅				
20		Downflow	Whole plant	Secondary	Kleiber <i>et al.</i> (1993)
32		Downflow	Whole plant	Secondary + 50% nitrification	Rogalla <i>et al.</i> (1992)
	20	Downflow	In the SAB (efficiency = 7.7% and 1.5 mgO ₂ /L)	Secondary	Stensel <i>et al.</i> (1988)
	56	Downflow	Whole plant	Secondary + partial nitrification	Condren (1990)
	35	Upflow	UASB + SAB	Secondary	Bof <i>et al.</i> (2001)

this efficiency reaches at the most 10% (Canler and Perret, 1993). These results are equivalent to those obtained by Stensel *et al.* (1988) in a downflow SAB of the same type. For aeration rates from 10 to 40 Nm³air/kgBOD_{applied}, oxygen transfer efficiencies varied between 9.2 and 5%. The average O₂ consumption calculated was 0.5 kgO₂/kgBOD_{applied}, lower than the typical values observed in conventional activated sludge (0.8 to 1.2 kgO₂/kgBOD_{applied}).

It is advisable that, for trickling filters, the influent has a BOD below about 100 mg/L, mainly due to the oxygen limitation, while for SAF such a limitation does not exist. The supply of air to reach the oxygen requirements of the aerobic process to have an effluent with BOD in the range of 20 to 30 mg/L, non nitrified, is about 35 to 40 m³air/kgBOD_{applied}.

(d) Summary of the design criteria for SAB units following UASB reactors

The main design criteria used for plants associating UASB reactors and submerged aerated biofilters (SAB) can be found in Table 45.3.

45.4 CONSTRUCTION ASPECTS

Among the urban wastewater treatment processes currently in operation, the submerged aerated biofilter is one of the most compact ones. SAB units can be built of concrete, fibreglass or steel with an anti-corrosion protective coating. In the case of these last two materials, and depending on the treatment capacity, the units can be pre-fabricated and transported to the plant location. Larger plants can have the pieces pre-fabricated and then transported for on-site assembly. Pre-fabrication greatly simplifies the planning and the implementation of the building site, lowering its size and duration. This aspect is in accordance with the peculiarities of the sanitation market for small localities, where, in general, there are infrastructure deficiencies for implementation of complex building sites.

Table 45.3. Main design criteria for plants associating UASB reactor + SAB

Parameter	UASB reactor	SAB	UASB reactor + SAB
Volumetric organic loading rate (kgBOD/ m ³ ·day)	0.85 to 1.2	3.0 to 4.0	–
Surface organic loading rate (gCOD/ m ² ·day)	15 to 18	55 to 80	–
BOD removal efficiency (%)	65 to 75	60 to 75	85 to 95
SS removal efficiency (%)	65 to 75	60 to 75	85 to 95
COD removal efficiency (%)	60 to 70	55 to 65	80 to 90
Aeration rate (Nm ³ /kgBOD _{removed})	–	25 to 40	–
Sludge production (kgTSS/kgCOD _{removed})	0.15 to 0.20	0.25 to 0.40	–
VS content in the sludge (VS/TS)	0.50 to 0.60	0.55 to 0.80	–
Aerobic sludge digestion efficiency in the UASB (% VS)	0.20 to 0.35	–	–

In the same way as for trickling filters, special attention should be given to the packing material of the filter. In the case of filter beds composed of materials of different densities and sizes, the turbulence generated by the washing operation can cause a mixture of the layers, and then loss of material or blockages. Although the aeration contributes to a significant mixing inside the biofilters, inside the filter bed the flow approaches plug flow. The positioning of the wastewater feeding points and the distribution, alignment and level of the collection gutters for the treated effluent should be thoroughly verified.

Another important aspect refers to the slab that supports the granular medium inside the biofilters. In upflow SAB treating anaerobic effluent, the slab should be built or covered with corrosion-resistant material, as it will be in permanent contact with sulphides present in the anaerobic effluent. Finally, the installation of an access window at the body of each biofilter, at the height of the aeration grid, can greatly facilitate occasional maintenance tasks.

45.5 OPERATIONAL ASPECTS

The retention of suspended solids and the growth of the attached biomass on the granular medium result in the constant increase of the head loss in biofilters with granular packing mediums. Control of this head loss is done through washings of the granular medium, accomplished in counter-current mode, just as in the rapid sand filters used in water treatment plants. The washing operation is composed of several intense hydraulic discharges of air and treated effluent. This intense turbulence temporarily expands the granular medium, promoting the removal of the excess biofilm. The washing frequency will depend on the evolution rate of the head loss, being around 1 washing/week in plants treating domestic sewage of average characteristics.

The objective of the washing operation of a SAB is to eliminate the excess biofilm accumulated in the process, during the operation between two sequential washings. Through washing, the biofilm thickness is reduced to ideal dimensions, which results in increase in the metabolic activities of the attached biomass and in

the reduction of the head loss in the granular medium. The washing can or cannot consist of the total interruption of the wastewater feeding.

The washing of SAB should be conveniently dosed to preserve the integrity of the filter bed and to retain a minimum amount of biomass necessary for the immediate start after washing. The volume of wash water used in SAB is estimated as 3 to 8% of the volume of treated wastewater. The volume of water necessary to wash the SAB can also be estimated as three times the volume of the filter bed.

The washing operation may comprise the total interruption of the unit under washing, and is done during times of low flow to the treatment plant. This usually happens during dawn, when several units can be stopped without great problems. After the wastewater feed is interrupted, strong hydraulic discharge sequences of air and wash water are applied to eliminate the excess attached biomass. Generally, several hydraulic discharges are applied in the opposite direction to the wastewater flow (back-washing).

The several stages that constitute a washing operation can follow different time intervals, but always attending the following stages in sequence:

- desegregation of the material, by means of strong discharges of air
- destructuring of the excess biofilm, through strong discharges of air and water (concomitant or not)
- water discharges, to remove the excess sludge of the granular medium
- removal of the wash sludge

Washing of a biofilter requires its isolation from the others, if the plant is composed of several units. The only connection between the units will be that placed in the area above the granular medium, which guarantees a system of communicating vessels among the treated water reservoirs of each SAB (supernatant liquid layer in

Table 45.4. Stages of a SAB washing operation

Stage	Time (min)	Objective	Necessary action
1	2	Interruption of the operation	Stop wastewater and air feeding (close valves)
2	2	Intense discharge of the liquid, at rates $>20 \text{ m}^3/\text{m}^2 \cdot \text{hour}$	Open the valve at the bottom of the SAB for 2 min
3	0.5	Interruption of the discharge of the liquid	Close the valve at the bottom of the SAB
4	2	Intense aeration, at rates greater than $50 \text{ m}^3/\text{m}^2 \cdot \text{hour}$	Open the valve in the aeration network of the SAB
5	0.5	Interruption of the intense aeration	Close the valve in the aeration network of the SAB
6	15	Repeat stages 2, 3, 4, and 5, in order, three more times	Follow the sequence of action described for each respective stage
7	1	Restart the operation of the SAB	Restart feeding of the SAB with wastewater and air (open the valves)

Total: 23 min

Source: SANEVIX Engenharia Ltda (1999)

Table 45.5. Main problems and possible solutions in the operation of granular stone bed SAB

Problems	Possible causes	Possible solutions
High concentrations of suspended solids in the effluent	– Biofilm loss/washing deficiency	– Extend washings of the SAB; wash with a higher frequency; increase air and water hydraulic loads during washing
	– Biofilm loss/toxicity	– Find and eliminate the emission sources of the toxic compounds
	– High concentration of suspended solids in the influent	– Evaluate the possibility of solids removal upstream of the reactor
Excessive increase in the head loss	– Organic or hydraulic overload	– Find and eliminate the contributing sources of excessive organic material or reduce loads, by decreasing the influent flow
	– Washing deficiency	– Extend washing of the SAB; wash with a higher frequency; increase air and water hydraulic loads during washing
	– Air distribution deficiency	– Evaluate the operation of the air distribution system (possible blockage)
	– Excessive aeration	– Reduce the aeration rate
Low organic matter removal efficiency (BOD, COD and SS)	– Organic overload, high concentration of organic matter in the influent	– Find and eliminate the contributing sources of excessive organic material or reduce loads, by decreasing the influent flow
	– Hydraulic overload, peak influent flows	– Limit influent flows to the reactor or equalise flows in industries
	– Presence of toxic compounds in the wastewater	– Find or eliminate the emission sources of toxic compounds
	– Low wastewater temperatures	– Evaluate the possibility of covering the reactor

Source: SANEVIX Engenharia Ltda (1999)

the upper part of each SAB). This connection aims to guarantee the supply of treated water, introduced in downflow mode in the granular medium during washing.

As mentioned, the washing operation should be accomplished in periods in which the plant operates below its maximum treatment capacity. If automation is possible, the operation should be programmed for the period between 2:00 and 6:00 a.m., when the influent flow to the plant reaches its lowest values. The stages listed in Table 45.4 should be followed during SAB washing.

Table 45.5 summarises the main problems and possible solutions to be adopted during the operation of SAB with granular stone bed.

Example 45.1

Design submerged aerated biofilters (SAB and SAF) for the post-treatment of effluents generated in a UASB reactor, considering the same design elements of trickling filters (Example 43.1):

Data:

- Population: $P = 20,000$ inhabitants
- Average influent flowrate: $Q_{av} = 3,000 \text{ m}^3/\text{d}$
- Maximum daily influent flowrate: $Q_{\text{max-d}} = 3,600 \text{ m}^3/\text{d}$
- Maximum hourly influent flowrate: $Q_{\text{max-h}} = 5,400 \text{ m}^3/\text{d}$
- Average influent BOD concentration to the UASB reactor: $S_{0\text{-UASB}} = 350 \text{ mg/L}$
- BOD removal efficiency expected in the UASB reactor: 70%
- Average effluent BOD concentration from the UASB reactor: $S_{e\text{-UASB}} = 105 \text{ mg/L}$
- Desired BOD concentration in the effluent from biofilter: $S_{e\text{-SAB}} < 30 \text{ mg/L}$
- Temperature of the wastewater: $T = 23 \text{ }^\circ\text{C}$ (average of the coldest month)
- Yield coefficient (sludge production) in biofilter: $Y = 0.75 \text{ kgTSS/kgBOD}_{\text{removed}}$
- Expected concentration for the sludge discharged from the secondary settling tank: $C_{\text{sludge}} = 1\%$
- Density of the sludge: $\gamma = 1,020 \text{ kgTSS/m}^3$.

Alternatives to be considered:

- Alternative A: Use of UASB reactor followed by SAB (packing bed of stones)
- Alternative B: Use of UASB reactor followed by SAF (packing bed of stones)
- Alternative C: Use of UASB reactor followed by SAF (packing bed of plastic)

Solution:**(a) Alternative A: Submerged aerated biofilter, SAB (packing bed of stones)**

- Submerged aerated biofilters with an upward flow and a stone packing medium with a porosity of approximately 40% will be used, with the following arrangement:
 - 1st layer = 30 cm of gravel grade 3
 - 2nd layer = 30 cm of gravel grade 2
 - 3rd layer = 40 cm of gravel grade 1
 - 4th layer = 100 cm of gravel grade 0
- The final effluent is expected to have the following characteristics:

BOD < 30 mg/L, COD < 90 mg/L and SS < 30 mg/L

Example 45.1 (Continued)

- Effluent organic load from the UASB reactor (influent to the biofilter):

$$\begin{aligned} \text{OL}_{e\text{-UASB}} &= Q_{av} \times S_{e\text{-UASB}} = 3,000\text{m}^3/\text{d} \times 0.105 \text{ kgBOD}/\text{m}^3 \\ &= 315 \text{ kgBOD}/\text{d} \end{aligned}$$

- SAB volume (V)

From Table 45.3, adopting $L_v = 4.0 \text{ kgBOD}/\text{m}^3 \cdot \text{d}$

$$V = \text{OL}_{e\text{-UASB}}/L_v = (315 \text{ kgBOD}/\text{d})/(4.0 \text{ kgBOD}/\text{m}^3 \cdot \text{d}) = 79 \text{ m}^3$$

- SAB area (A)

Considering a filter bed height of 2.0 m:

$$A = V/h = (79.0 \text{ m}^3)/(2.0 \text{ m}) = 39.5 \text{ m}^2$$

Therefore, the biofilter will have a circular section with a diameter of 7.1 m, and will be divided into four equal parts.

- Upflow velocity or hydraulic loading rate (v)

$$v = Q_{av}/A = (3,000 \text{ m}^3/\text{d})/(39.5 \text{ m}^2) = 75.9 \text{ m}/\text{d} = 3.2 \text{ m}/\text{hour}$$

- Air demand (without nitrification)

From Table 45.2, considering an aeration rate of $30 \text{ Nm}^3\text{air}/\text{kgBOD}_{\text{applied}}$:

$$\begin{aligned} Q_{\text{air}} &= \text{aeration rate} \times \text{OL}_{e\text{-UASB}} \\ &= (30 \text{ Nm}^3\text{air}/\text{kgBOD}_{\text{applied}}) \times 315 \text{ kgBOD}/\text{d} \\ Q_{\text{air}} &= 9,450 \text{ Nm}^3\text{air}/\text{d} \end{aligned}$$

The airflow per biofilter will be $9,450/4 = 2,363 \text{ m}^3/\text{day}$, with a pressure of 5.0 m.w.c. (metres of water column).

- Sludge production for dewatering

Sludge production in the SAB:

$$\begin{aligned} P_{\text{sludge}} &= Y \times \text{OL}_{e\text{-UASB}} = 0.75 \text{ kgTSS}/\text{kgBOD}_{\text{applied}} \times 315 \text{ kgBOD}/\text{d} \\ &= 236 \text{ kgTSS}/\text{d} \end{aligned}$$

Considering 75% of volatile solids:

$$P_{\text{sludge-volatile}} = 236 \text{ kgTSS}/\text{d} \times 0.75 = 177 \text{ kgVSS}/\text{d}$$

Sludge production in the UASB reactor

Production due to the wastewater treatment:

$$\begin{aligned} P_{\text{sludge}} &= Y \times \text{BOD}_{\text{applied}} \\ &= 0.28 \text{ kgTSS}/\text{kgBOD}_{\text{applied}} \\ &\quad \times 3,000 \text{ m}^3/\text{d} \times 0.350 \text{ kgBOD}/\text{m}^3 \\ &= 294 \text{ kgTSS}/\text{d} \end{aligned}$$

Example 45.1 (Continued)

Total production, including the secondary aerobic sludge returned to the UASB reactor, considering 30% reduction of the aerobic sludge (VSS) in the UASB reactor:

$$P_{\text{sludge}} = 294 + (236 - 0.30 \times 177) = 477 \text{ kgTSS/d}$$

(b) Alternative B: Submerged aerated filter, SAF (packing bed of stones)

- Submerged aerated filters with upward flow will be used. The packing medium will comprise gravel 4, with a specific surface area of $70 \text{ m}^2/\text{m}^3$ and 57% void spaces.
- For effluent BOD $< 30 \text{ mg/L}$, it will be adopted a surface loading rate (L_s) of $14 \text{ gBOD}/\text{m}^2 \cdot \text{d}$ ($0.014 \text{ kgBOD}/\text{m}^2 \cdot \text{d}$)
- Calculation of the volumetric organic load (L_v)

$$\begin{aligned} L_v &= \text{specific surface area of the packing medium} \times L_s \\ &= 70 \text{ m}^2/\text{m}^3 \times 0.014 \text{ kgBOD}/\text{m}^2 \cdot \text{d} \\ L_v &= 1.0 \text{ kgBOD}/\text{m}^3 \cdot \text{d}. \end{aligned}$$

- Calculation of the SAF volume (V)

$$V = OL_{e\text{-UASB}}/L_v = (315 \text{ kgBOD}/\text{d})/(1.0 \text{ kgBOD}/\text{m}^3 \cdot \text{d}) = 315 \text{ m}^3$$

- SAF area (A)
Considering stone bed height of 3.0 m:

$$A = V/h = (315 \text{ m}^3)/(3.0 \text{ m}) = 105 \text{ m}^2$$

Adopt two units of 52.5 m^2 each, with $7.3 \text{ m} \times 7.3 \text{ m}$, or two circular units with a diameter of 8.2 m each.

- height of the inlet compartment = 0.8 m
 - height of the packing medium = 3.0 m
 - water height over the packing material = 0.5 m
 - total useful height = 4.3 m.
 - Air demand (without nitrification)
From Table 45.2, considering an aeration rate of $30 \text{ Nm}^3 \text{ air}/\text{kgBOD}_{\text{applied}}$:
- $$\begin{aligned} Q_{\text{air}} &= \text{aeration rate} \times OL_{e\text{-UASB}} \\ &= (30 \text{ Nm}^3 \text{ air}/\text{kgBOD}_{\text{applied}}) \times 315 \text{ kgBOD}/\text{d} \\ Q_{\text{air}} &= 9,450 \text{ Nm}^3 \text{ air}/\text{d} = 394 \text{ Nm}^3 \text{ air}/\text{hour} \end{aligned}$$
- air flow per filter = $394/2 = 197 \text{ m}^3/\text{hour}$ or $3.3 \text{ m}^3/\text{minute}$ ($4.0 \text{ m}^3/\text{minute}$ will be adopted for each unit, with a pressure of 5 m.w.c.)

Example 45.1 (Continued)

- air distribution system: by coarse bubbles, through perforated tubes or coarse bubble diffusers
- Design of the secondary settling tank
From Table 43.2, the settling tanks should be designed with surface hydraulic loading rates between 16 and 32 m³/m²·d. Adopted value: L_h = 24 m³/m²·d

$$A = Q_{av}/L_h = (3,000 \text{ m}^3/\text{d})/(24 \text{ m}^3/\text{m}^2 \cdot \text{d}) = 125 \text{ m}^2$$

Adopt two circular settling tanks with peripheral traction sludge scrapers, as follows:

$$\begin{aligned} \text{Diameter} &= 9.0 \text{ m}; \text{ useful side-wall depth} = 3.5 \text{ m}; \text{ surface area, per unit} \\ &= 63.5 \text{ m}^2 \end{aligned}$$

According to Table 43.2, the maximum hydraulic surface loading rate should be between 40 and 48 m³/m²·d and the calculated value is:

$$L_h = Q_{\max-h}/A = (5,400 \text{ m}^3/\text{d})/(2 \times 63.5 \text{ m}^2) = 43 \text{ m}^3/\text{m}^2 \cdot \text{d}$$

The sludge from the secondary settling tanks will be pumped to the inlet of the UASB reactors. For sludge removed with 1% solids, the daily volume to be pumped is as follows:

$$\begin{aligned} V_{\text{sludge}} &= P_{\text{sludge}}/(\gamma \times C_{\text{sludge}}) = (236 \text{ kgSS/d})/(1,020 \text{ kg/m}^3 \times 0.01) \\ &= 23.1 \text{ m}^3/\text{d} \end{aligned}$$

- Sludge production for dewatering
Sludge production in the SAF:

$$\begin{aligned} P_{\text{sludge}} &= Y \times \text{OL}_{e-\text{UASB}} = 0.75 \text{ kgSS/kgBOD}_{\text{applied}} \times 315 \text{ kgBOD/d} \\ &= 236 \text{ kgTSS/d} \end{aligned}$$

Considering 75% of volatile solids:

$$P_{\text{sludge-volatile}} = 236 \text{ kgTSS/d} \times 0.75 = 177 \text{ kgVSS/d}$$

Sludge production in the UASB reactor

Production due to the wastewater treatment:

$$\begin{aligned} P_{\text{sludge}} &= Y \times \text{BOD}_{\text{applied}} \\ &= 0.28 \text{ kgSS/kgBOD}_{\text{applied}} \times 3,000 \text{ m}^3/\text{d} \times 0.350 \text{ kgBOD/m}^3 \\ &= 294 \text{ kgTSS/d} \end{aligned}$$

Total production, including the secondary aerobic sludge returned to the UASB reactor, considering 30% reduction of the aerobic sludge (VSS) in the UASB reactor:

$$P_{\text{sludge}} = 294 + (236 - 0.30 \times 177) = 477 \text{ kgTSS/d}$$

Example 45.1 (Continued)**(c) Alternative C: Submerged aerated filter, SAF (packing bed of plastic)**

- Submerged aerated filters with upward flow will be used. The packing medium will comprise plastic, with a specific surface area of $130 \text{ m}^2/\text{m}^3$ and 95% void spaces.
- For effluent BOD $< 30 \text{ mg/L}$, it will be adopted a surface loading rate (L_s) of $14 \text{ gBOD}/\text{m}^2 \cdot \text{d}$ ($0.014 \text{ kgBOD}/\text{m}^2 \cdot \text{d}$)
- Calculation of the volumetric organic load (L_v)

$$\begin{aligned} L_v &= \text{specific surface area of the packing medium} \times L_s \\ &= 130 \text{ m}^2/\text{m}^3 \times 0.014 \text{ kgBOD}/\text{m}^2 \cdot \text{d} \\ &= 1.8 \text{ kgBOD}/\text{m}^3 \cdot \text{d}. \end{aligned}$$

- Calculation of the SAF volume (V)

$$V = \text{OL}_{e\text{-UASB}}/L_v = (315 \text{ kgBOD}/\text{d})/(1.8 \text{ kgBOD}/\text{m}^3 \cdot \text{d}) = 175 \text{ m}^3$$
- SAF area (A)
Considering stone bed height of 3.0 m:

$$A = V/h = (175 \text{ m}^3)/(3.0 \text{ m}) = 58 \text{ m}^2$$

Adopt two units of 29 m^2 each, with $5.4 \text{ m} \times 5.4 \text{ m}$, or two circular units with a diameter of 6.1 m each.

- height of the inlet compartment = 0.8 m
- height of the packing medium = 3.0 m
- water height over the packing material = 0.5 m
- total useful height = 4.3 m.
- Air demand (without nitrification)
Identical to alternative (b)
- Secondary settling tanks
Identical to alternative (b)
- Sludge production for dewatering
Identical to alternative (b)

Part Six

References

- Arvin, E. and Harremões, P. (1991) Concepts and models for biofilm reactor performance. *Water Sci. Technol.* **22**(1/2), 171–192.
- Atkinson, B. (1981) Immobilised biomass – a basis for process development in wastewater treatment. In *Biological fluidised bed treatment of water and wastewater* (eds Atkinson and Cooper), Chapter 1, pp. 22–34, Ellis Horwood Limited Pub., UK.
- Bailey, J.E. and Ollis, D.F. (1986) *Biochemical Engineering Fundamentals*, 2nd edn, McGraw-Hill, New York.
- Bof, V.S., Sant'ana, T.D., Wanke, R., Silva, G.M., Salim, F.P.C., Nardoto, J.I.O., Netto, E.S. and Pegoretti, J.M. (2001) ETÉs compactas associando reatores anaeróbios e aeróbios ampliam a cobertura do saneamento no estado do Espírito Santo *Anais do XXVII Congresso Brasileiro de Engenharia Sanitária e Ambiental (ABES, João Pessoa (PB))* (in Portuguese).
- Bonhomme, M., Rogalla, F., Boisseau, G. and Sibony, J. (1990) Enhancing nitrogen removal in activated sludge with fixed biomass. *Water Sci. Technol.* **22**(1/2), 127–135.
- Canler, J.P.E. and Perret, J.M. (1993) Biofiltres aérys: évaluation du procédé sur 12 unités industrielles *Proceedings of the 2nd International Specialised Conference on Biofilm Reactors (Paris, France)* pp. 27–37.
- Carrand, G., Capon, B., Rasconi, A.E. and Brenner, R. (1989) Elimination of carbonaceous and nitrogenous pollutants by a twin-stage fixed growth process. *Water Sci. Technol.* **22**(1/2), 261–272.
- Chisti, M.Y., Fujimoto, K. and Moo Young, M. (1989) *Biotechnology Process – Scale up and Mixing* (eds C.S. Ho and J.Y. Oldshue), AIChE, New York.
- Condren, A.J. (1990) *Technology Assessment of the Biological Aerated Filter*. Technical Report EPA/600/2–90/015, U.S.EPA, 103 p.
- Fazolo, A. (2000) Nitrificação e desnitrificação simultânea em um único reator aeróbio/anaeróbio alimentado com efluente de reator anaeróbio horizontal de leito fixo. Projeto de pesquisa de Doutorado (EESC/USP) (in Portuguese).
- Gilles, P. (1990) Industrial scale applications of fixed biomass on the Mediterranean seaboard: design, operating results. *Water Sci. Technol.* **22**(1/2), 281–292.
- Gonçalves, R.F. (1993) Elimination biologique du phosphore des eaux résiduaires urbaines par des biofiltres immergés, Thèse de Doctorat, L'Institut National des Sciences Appliquées (INSA), Toulouse, França, 169 p.

- Gonçalves, R.F., Charlier, A.C. and Sammut, F. (1994). Primary fermentation of soluble and particulate organic matter for wastewater treatment. *Water Sci. Technol.* **30**(6) 53–62.
- Gonçalves, R.F., Chernicharo, C.A.L., Andrade Neto, C.O., Alem Sobrinho, P., Kato, M.T., Costa, R.H.R., Aisse, M.M. and Zaiat, M. (2001). Pós-tratamento de efluentes de reatores anaeróbios por reatores com biofilme. Cap. 4. In *Pós-tratamento de efluentes de reatores anaeróbios* (coord. C.A.L. Chernicharo), 544 p., FINEP/PROSAB, Rio de Janeiro, Brasil (in Portuguese).
- Gonçalves, R.F., Passamani, F.R.F., Salim, F.P., Silva, A.L.B., Martineli, G. and Bauer, D.G. (2000) Associação de um reator UASB e biofiltros aerados submersos para tratamento de esgoto sanitário. In *Pós-tratamento de efluentes de reatores anaeróbios – coletânea de trabalhos* (coord. C.A.L. Chernicharo), vol. 1, 220 p., FINEP/PROSAB (in Portuguese).
- Gonçalves R.F. and Rogalla, F. (1994) Biofiltros aerados para remoção de nitrogênio de águas residuárias sob diversas temperaturas. *Anais eletrônicos do XXIV Congresso Interamericano de Engenharia Sanitária e Ambiental – 30 de outubro a 4 de novembro de 1994 (Buenos Aires, Argentina)* (in Portuguese).
- Gonçalves, R.F., Sammut, F. and Rogalla, F. (1992) High rate biofilter – simultaneous phosphorus precipitation and nitrogen removal – chemical water and wastewater treatment II (eds H.H. Hahn and R. Klute), pp. 357–372, Springer-Verlag, Berlin/Heidelberg.
- Göncü, I.E. and Harremões, P. (1985) Nitrification in rotating disc systems – I: criteria for transition from oxygen to ammonia rate limitation. *Water Res.* **19**, 1119–1127.
- Göncü, I.E. and Harremões, P. (1990) Nitrification in rotating disc systems – II: criteria for simultaneous mineralization and nitrification. *Water Res.* **24**, 499–505.
- Gros, H. and Karl, V. (1993) Multilayer filtration and fixed bed systems for advanced wastewater treatment *Proceedings of the European Congress on Water Filtration (15–17 March, Oostend, Belgium)*, pp. 3.51–3.55.
- Harremões, P. (1982) Criteria for nitrification in fixed film reactors. *Water. Sci. Technol.* **14**, 167–187.
- Hatzifotiadou, O. (1989) Contribution à l'étude de l'hydrodynamique et du transfert de matière gaz-liquide dans un réacteur à lit fluidisé triphasique. Thèse de Doctorat, L'Institut National des Sciences Appliquées (INSA). Toulouse, 174 p.
- Heath, M.S., Wirtel, S.A. and Rittmann, B.E. (1990) Simplified design of biofilm processes using normalized loading curves. *Res. J. Water Pollut. Control Fed.* **62**(2), 185–192.
- Jepsen, S.E., Laursen, K., Jansen, J.L.C. and Harremões, P. (1992) Denitrification in submerged filters of nitrified wastewater and chemical precipitated water. *Chemical Water and Wastewater Treatment II* (eds H.H. Hahn and R. Klute), pp. 371–387, Springer-Verlag, Berlin/Heidelberg.
- Kleiber, B., Roudon, G., Bigot, B. and Sibony, J. (1993) Assessment of biofiltration at industrial scale *Proceedings of the 2nd International Specialised Conference on Biofilm Reactors (Paris, France)*, pp. 271–283.
- Lacamp, B., Hansen, F., Penillard, P. and Rogalla, F. (1992) Wastewater nutrient removal with advanced biofilm reactors. *Water Sci. Technol.* **27**(5/6), 263–276.
- Lazarova, V. and Manem, J. (1994) Advance in biofilm aerobic reactors ensuring effective biofilm activity control *Water Sci. Technol.* **29**(10/11), 319–327.
- Lazarova, V. and Manem, J. (1995) Biofilm characterization and activity analysis in water and wastewater treatment. *Water Res.* **29**(10), 2227–2245.
- Lertpocasombut, K., Capdeville, B. and Roques, H. (1988) Application of aerobic biofilm growth in a three-phase fluidized-bed reactor for biological wastewater treatment *2nd Asian Conference on Water Pollution Control in Asia (Bangkok, Thailand)*.
- Lessel, T.H. (1993) Upgrading and nitrification by submerged bio-film reactors – experiences from a large-scale plant *Proceedings of the 2nd International Specialised Conference on Biofilm Reactors (Paris, France)*, pp. 231–238.

- Matos, T.A., Silva, H.T.M. and Gonçalves, R.F. (2001) Uso simultâneo de um biofiltro aerado submerso para tratamento secundário de esgoto sanitário e para biodesodorização de ar atmosférico contendo gás sulfídrico (H₂S). *Anais do XXVII Congresso Brasileiro de Engenharia Sanitária e Ambiental (ABES, João Pessoa (PB))* (in Portuguese).
- Metcalf and Eddy (1991) *Wastewater Engineering – Treatment, Disposal and Reuse*, 3rd edn, 1334 p., McGraw-Hill, Inc., New York.
- Okey, W. and Albertson, O.E. (1987) The role of diffusion in regulating rate and masking temperature effects in fixed film nitrification *Proceedings of the 60th Annual Conference of Water Pollution Control Federation*.
- Oodegard, H., Rusten, B. and Westrum, T. (1993) A new moving bed biofilm reactor – applications and results *Proceedings of the 2nd International Specialised Conference on Biofilm Reactors (Paris, France)*, pp. 221–229.
- Parker, D.S., Lutz, M.P. and Pratt, A.M. (1990) New trickling filter applications in the U.S.A. *Water Sci. Technol.* **22**(1/2), 215–226.
- Partos, J., Richard, Y. and Amar, D. (1985) Elimination de la pollution carbonée sur cultures fixées aérobies. Le procédé Biofor. *TSM. L'Eau.* (4), 193–198.
- Pujol, R., Canler, J.P. and Iwema, A. (1992) Biological aerated filters: an attractive and alternative biological process. *Water Sci. Technol.* **26**(3/4), 693–702.
- Ravarini, P., Coutelle, J. and Damez, F. (1988) Le traitement d'eau potable à Dennemont – Dénitrification et nitrification biologiques à grande échelle. *TSM L'Eau.* **83**, 235–239.
- Richard, Y. and Cyr, R. (1990) Les possibilités de traitement par cultures fixées aérobies. *TSM L'Eau.* **85**(7/8), 389–393.
- Rittmann, B.E. (1982) The effect of shear stress on biofilm loss rate. *Biotechnol. Bioeng.* **24**, 501–506.
- Rogalla, F., Roudon, G., Sibony, J. and Blondeau, F. (1992) Minimising nuisances by covering compact sewage plants. *Water Sci. Technol.* **25**(4/5), 363–374.
- Saez, P.B., Chang, H.T. and Rittmann, B.E. (1988) Modeling steady-state substrate inhibited biofilms *International Conference on Physicochemical and Biological Detoxification of Hazardous Wastes*.
- Sagberg, P., Dauthuille, P. and Hamon, M. (1992) Biofilm reactors: a compact solution for the upgrading of wastewater treatment plants. *Water Sci. Technol.* **26**(3/4), 733–742.
- Sanevix Engenharia Ltda (1999) Manual de operação de ETEs do tipo UASB + BFs – Vitória (ES). 88 p. (in Portuguese).
- Sibony, J. (1983) Applications industrielles des cultures fixées en épuration d'eaux résiduaires *5ème Journée Scientifique: Léau, la recherche et l'environnement (25–27 outubro, Lille, France)*, pp. 387–397.
- Stensel, H.D., Brenner, R.C., Lee, K.M., Meller, H. and Rakness, K. (1988) Biological aerated filter evaluation. *J. Environ. Eng.* **114**(3) 655–671.
- Strohmeier, A. and Schroeter, I. (1993) Experiences with biological filtration in advanced waste water treatment *Proceedings of the European Congress on Water Filtration (15–17 March, Oostend, Belgium)*, pp. 3.39–3.50.
- Tschui, M., Boller, M., Gujer, W., Eugster, J., Mäder, C. and Stengel, C. (1993) Tertiary nitrification in aerated pilot biofilters *Proceedings of the 2nd International Specialised Conference on Biofilm Reactors (Paris, France)*, pp. 109–116.
- Upton, J.B. and Green, B. (1995) A successful strategy for small treatment plants. *Water Quality Int.* (4), 12–14.
- Upton, J. and Stephenson, T. (1993) BAF – Upflow or downflow – the choice exists *Symposium on Wastewater Treatment by Biological Aerated Filters – Latest Developments, (Cranfield Institut of Technology, Cranfield, UK)*.
- WEF (1992) Design manual of wastewater treatment plants, vol I, Chapter 12 *Manual of Practice* n. 8 – 829 p.

- WEF (1996) Operation of municipal wastewater treatment plants. *Manual of Practice* MOP 10, vol. 2, 3rd edn.
- Zaiat, M. (1996) Desenvolvimento de Reator Anaeróbio Horizontal de Leito Fixo para tratamento de águas residuárias. São Carlos. SP. Tese (Doutorado) Escola de Engenharia de São Carlos, Universidade de São Paulo. (in Portuguese).

PART SEVEN

Sludge treatment and disposal

46	Introduction to sludge management	1167
47	Sludge characteristics and production	1170
48	Main contaminants in sludge	1197
49	Sludge stabilisation	1214
50	Sludge thickening and dewatering	1242
51	Pathogen removal from sludge	1286
52	Assessment of sludge treatment and disposal alternatives	1315
53	Land application of sewage sludge	1328
54	Sludge transformation and disposal methods	1373
55	Environmental impact assessment and monitoring of final sludge disposal	1392
	References	1403

Introduction to sludge management

M. von Sperling, C.V. Andreoli

The management of sludge originating from wastewater treatment plants is a highly complex and costly activity, which, if poorly accomplished, may jeopardise the environmental and sanitary advantages expected in the treatment systems. The importance of this practice was acknowledged by Agenda 21, which included the theme of environmentally wholesome management of solid wastes and questions related with sewage, and defined the following orientations towards its administration: reduction in production, maximum increase of reuse and recycling, and the promotion of environmentally wholesome treatment and disposal.

The increasing demands from society and environmental agencies towards better environmental quality standards have manifested themselves in public and private sanitation service administrators. Due to the low indices of wastewater treatment prevailing in many developing countries, a future increase in the number of wastewater treatment plants is naturally expected. As a consequence, the amount of sludge produced is also expected to increase. Some environmental agencies in these countries now require the technical definition of the final disposal of sludge in the licensing processes. These aspects show that solids management is an increasing matter of concern in many countries, tending towards a fast-growing aggravation in the next years, as more wastewater treatment plants are implemented.

As mentioned in Chapter 5, the term ‘**sludge**’ has been used to designate the solid by-products from wastewater treatment. In the biological treatment processes, part of the organic matter is absorbed and converted into microbial biomass, generically called biological or secondary sludge. This is mainly composed of biological solids, and for this reason it is also called a **biosolid**. The utilisation of this term still requires that the chemical and biological characteristics of the sludge are compatible with productive use, for example, in agriculture. The term ‘biosolids’ is a way of emphasising its beneficial aspects, giving more value to productive uses, in comparison with the mere non-productive final disposal by means of landfills or incineration.

The adequate final destination of biosolids is a fundamental factor for the success of a sanitation system. Nevertheless, this activity has been neglected in many developing countries. It is usual that in the design of wastewater treatment plants, the topic concerning sludge management is disregarded, causing this complex activity to be undertaken without previous planning by plant operators, and frequently under emergency conditions. Because of this, inadequate alternatives of final disposal have been adopted, largely reducing the benefits accomplished by the sewerage systems.

Although the sludge represents only 1% to 2% of the treated wastewater volume, its management is highly complex and has a cost usually ranging from 20% to 60% of the total operating costs of the wastewater treatment plant. Besides its economic importance, the final sludge destination is a complex operation, because it is frequently undertaken outside the boundaries of the treatment plant.

This part of the book intends to present an integrated view of all sludge management stages, including generation, treatment and final disposal. The sections also aim at reflecting the main sludge treatment and final disposal technologies potentially used in warm-climate regions, associated with the wastewater treatment processes described throughout the book.

The understanding of the various chapters in this part of the book depends on the knowledge of the introductory aspects and general overview presented in **Chapter 5**, namely:

- introduction to sludge treatment and disposal
- relationships in sludge: solids levels, concentration and flow
- summary of the quantity of sludge generated in the wastewater treatment processes
- sludge treatment stages
- introduction to sludge thickening, stabilisation, dewatering, disinfection and final disposal

These topics are analysed again in this part of the book, at a more detailed level. The main topics covered are listed below.

Main topic	Items covered
Sewage sludge: characteristics and production	<ul style="list-style-type: none"> • Sludge production in wastewater treatment plants • Fundamental relationships among variables • Sludge production estimates • Mass balance in sludge treatment
Main sludge contaminants	<ul style="list-style-type: none"> • Metals • Pathogenic organisms • Organic contaminants • Discharge of effluents into public sewerage systems
Sludge stabilisation processes	<ul style="list-style-type: none"> • Anaerobic digestion • Aerobic digestion
Removal of the water content from sewage sludges	<ul style="list-style-type: none"> • Sludge thickening • Sludge conditioning • Drying bed • Centrifuge • Filter press • Belt press • Thermal drying
Pathogen removal	<ul style="list-style-type: none"> • Sludge disinfection mechanisms • Composting • Autothermal aerobic digestion • Alkaline stabilisation • Pasteurisation • Thermal drying
Assessment of alternatives for sludge management at wastewater treatment plants	<ul style="list-style-type: none"> • Trends on sludge management in some countries • Conditions to be analysed before assessing alternatives • Methodological approach for the selection of alternatives • Organisation of an assessment matrix • Sludge management at the wastewater treatment plant
Land disposal of sludge	<ul style="list-style-type: none"> • Beneficial uses of biosolids • Requirements and associated risks • Use and handling • Storage, transportation, application and incorporation • Land disposal without beneficial purposes: <i>landfarming</i> • Criteria and regulations in some countries
Main types of sludge transformation and disposal	<ul style="list-style-type: none"> • Thermal drying • Wet air oxidation • Incineration • Disposal in landfills
Environmental impact assessment and compliance monitoring of final sludge disposal	<ul style="list-style-type: none"> • Description of the activity from the environmental point of view • Alternatives of final sludge disposal • Potentially negative environmental impacts • Indicators and parameters for final sludge disposal monitoring • Programme for monitoring the impacts

Sludge characteristics and production

M. von Sperling, R.F. Gonçalves

47.1 SLUDGE PRODUCTION IN WASTEWATER TREATMENT SYSTEMS

The understanding of the concepts presented in this chapter depends on the previous understanding of the more introductory concepts of sludge management presented in Chapter 5.

The amount of sludge produced in wastewater treatment plants, and that should be directed to the sludge processing units, can be expressed in terms of *mass* (g of total solids per day, dry basis) and *volume* (m³ of sludge per day, wet basis). Section 47.2 details the methodology for mass and volume calculations. A simplified approach is assumed here, expressing sludge production on *per capita* and COD bases.

In biological wastewater treatment, part of the COD removed is converted into biomass, which will make up the biological sludge. Various chapters of this book show how to estimate the excess sludge production as a function of the COD or BOD removed from the wastewater. Table 47.1 presents, for the sake of simplicity, the mass of suspended solids wasted per unit of *applied* COD (or influent COD), considering typical efficiencies of COD removal from several wastewater treatment processes. For instance, in the activated sludge process – extended aeration – each

Table 47.1. Characteristics and quantities of sludge produced in various wastewater treatment systems

Wastewater treatment system	Characteristics of the sludge produced and wasted from the liquid phase (directed to the sludge treatment stage)			
	kgSS/ kgCOD applied	Dry solids content (%)	Mass of sludge (gSS/ inhabitant·d) (a)	Volume of sludge (L/ inhabitant·d) (b)
Primary treatment (conventional)	0.35–0.45	2–6	35–45	0.6–2.2
Primary treatment (septic tanks)	0.20–0.30	3–6	20–30	0.3–1.0
Facultative pond	0.12–0.32	5–15	12–32	0.1–0.25
Anaerobic pond – facultative pond				
• Anaerobic pond	0.20–0.45	15–20	20–45	0.1–0.3
• Facultative pond	0.06–0.10	7–12	6–10	0.05–0.15
• Total	0.26–0.55	–	26–55	0.15–0.45
Facultative aerated lagoon	0.08–0.13	6–10	8–13	0.08–0.22
Complete-mix aerated – sedim. pond	0.11–0.13	5–8	11–13	0.15–0.25
Septic tank + anaerobic filter				
• Septic tank	0.20–0.30	3–6	20–30	0.3–1.0
• Anaerobic filter	0.07–0.09	0.5–4.0	7–9	0.2–1.8
• Total	0.27–0.39	1.4–5.4	27–39	0.5–2.8
Conventional activated sludge				
• Primary sludge	0.35–0.45	2–6	35–45	0.6–2.2
• Secondary sludge	0.25–0.35	0.6–1	25–35	2.5–6.0
• Total	0.60–0.80	1–2	60–80	3.1–8.2
Activated sludge – extended aeration	0.50–0.55	0.8–1.2	40–45	3.3–5.6
High-rate trickling filter				
• Primary sludge	0.35–0.45	2–6	35–45	0.6–2.2
• Secondary sludge	0.20–0.30	1–2.5	20–30	0.8–3.0
• Total	0.55–0.75	1.5–4.0	55–75	1.4–5.2
Submerged aerated biofilter				
• Primary sludge	0.35–0.45	2–6	35–45	0.6–2.2
• Secondary sludge	0.25–0.35	0.6–1	25–35	2.5–6.0
• Total	0.60–0.80	1–2	60–80	3.1–8.2
UASB reactor	0.12–0.18	3–6	12–18	0.2–0.6
UASB + aerobic post-treatment (c)				
• Anaerobic sludge (UASB)	0.12–0.18	3–4	12–18	0.3–0.6
• Aerobic sludge (post-treatment) (d)	0.08–0.14	3–4	8–14	0.2–0.5
• Total	0.20–0.32	3–4	20–32	0.5–1.1

Notes:

- In the units with long sludge detention times (e.g., ponds, septic tanks, UASB reactors, anaerobic filters), all values include digestion and thickening (which reduce sludge mass and volume) occurring within the unit itself.
- (a) Assuming 0.1 kgCOD/inhabitant·d and 0.06 kgSS/inhabitant·d
- (b) Litres of sludge/inhabitant·d = [(gSS/inhabitant·d)/(dry solids (%))] × (100/1,000) (assuming a sludge density of 1,000 kg/m³)
- (c) Aerobic post-treatment: activated sludge, submerged aerated biofilter, trickling filter
- (d) Aerobic sludge withdrawn from UASB tanks, after reduction of mass and volume through digestion and thickening that occur within the UASB reactor (the aerobic excess sludge entering the UASB is also smaller, because, in this case, the solids loss in the secondary clarifier effluent becomes more influential).

Sources: Qasim (1985), EPA (1979, 1987), Metcalf and Eddy (1991), Jordão and Pessoa (1995), Gonçalves (1996), Aisse *et al.* (1999), Chernicharo (1997), Gonçalves (1999)

kilogram of COD influent to the biological stage generates 0.50 to 0.55 kg of suspended solids (0.50 to 0.55 kgSS/kgCOD applied).

Considering that every inhabitant contributes approximately 100 gCOD/day (0.1 kgCOD/inhab·d), the per capita SS (suspended solids) contribution can be also estimated. In wastewater treatment processes in which physical mechanisms of organic matter removal prevail, there is no direct link between the solids production and the COD removal. In such conditions, Table 47.1 presents *per capita* SS productions based on typical efficiencies of SS removal in the various stages of the wastewater treatment solids.

The solids presented in Table 47.1 constitute the solids fraction of the sludge; the remainder is made up of plain water. The dry solids (total solids) concentration expressed in percentage is related to the concentration in mg/L (see Section 47.3). A 2%-dry-solids sludge contains 98% water; in other words, in every 100 kg of sludge, 2 kg correspond to dry solids and 98 kg are plain water.

The per capita daily volume of sludge produced is calculated considering the daily per capita load and the dry solids concentration of the sludge (see formula in Table 47.1 and Section 47.3).

In this part of the book, the expressions *dry solids*, *total solids* and *suspended solids* are used interchangeably, since most of the total solids in the sludge are suspended solids.

From Table 47.1, it is seen that among the processes listed, stabilisation ponds generate the smaller volume of sludge, whereas conventional activated sludge systems produce the largest sludge volume to be treated. The reason is that the sludge produced in the ponds is stored for many years in the bottom, undergoing digestion (conversion to water and gases) and thickening, which greatly reduce its volume. On the other hand, in the conventional activated sludge process, sludge is not digested in the aeration tank, because its residence time (sludge age) is too low to accomplish this.

Table 47.1 is suitable exclusively for preliminary estimates. It is important to notice that the mass and volumes listed in the table are related to the sludge that is directed to the treatment or processing stage. Section 47.2 presents the sludge quantities processed in each sludge treatment stage and in the final disposal.

47.2 SLUDGE CHARACTERISTICS AT EACH TREATMENT STAGE

Sludge characteristics vary as the sludge goes through several treatment stages. The major changes are:

- *thickening, dewatering*: increase in the concentration of total solids (dry solids); reduction in sludge volume
- *digestion*: decrease in the load of total solids (reduction of volatile suspended solids)

These changes can be seen in Table 47.2, which presents the solids load and concentration through the sludge treatment stages. Aiming at a better understanding,

Table 47.2. Sludge characteristics in each stage of the treatment process

Wastewater treatment system	Sludge removed from the liquid phase				Thickened sludge			Digested sludge			Dewatered sludge			Per-capita volume (L/inhabitant-d)
	Sludge mass (gSS/inhabitant-d)	Dry solids conc. (%)	Sludge mass (gSS/inhabitant-d)	Thickening process	Dry solids conc. (%)	Sludge mass (gSS/inhabitant-d)	Digestion process	Dry solids conc. (%)	Sludge mass (gSS/inhabitant-d)	Dewatering process	Dry solids conc. (%)	Per-capita volume (L/inhabitant-d)		
<i>Primary treatment (conventional)</i>	35-45	2-6	35-45	Gravity	4-8	25-28	Anaerobic	4-8	25-28	Drying bed	35-45	0.05-0.08		
<i>Primary treatment (septic tanks)</i>	20-30	3-6	-	-	-	-	-	-	20-30	Drying bed	30-40	0.05-0.10		
<i>Facultative pond</i>	20-25	10-20	-	-	-	-	-	-	20-25	Drying bed	30-40	0.05-0.08		
<i>Anaerobic pond - facultative pond</i>														
• Anaerobic pond	20-45	15-20	-	-	-	20-45	-	-	20-45	Drying bed	30-40	0.05-0.14		
• Facultative pond	6-10	7-12	-	-	-	6-10	-	-	6-10	Drying bed	30-40	0.015-0.03		
• Total	26-55	-	-	-	-	26-55	-	-	26-55	Drying bed	30-40	0.06-0.17		
<i>Facultative aerated lagoon</i>	8-13	6-10	-	-	-	8-13	-	-	8-13	Drying bed	30-40	0.02-0.04		
<i>Complete-mix aerat. lagoon - sedim. pond</i>	11-13	5-8	-	-	-	11-13	-	-	11-13	Drying bed	30-40	0.025-0.04		
<i>Septic tank + anaerobic filter</i>														
• Septic tank	20-30	3-6	-	-	-	20-30	-	-	20-30	Drying bed	30-40	0.05-0.10		
• Anaerobic filter	7-9	0.5-4.0	-	-	-	7-9	-	-	7-9	Drying bed	30-40	0.02-0.03		
• Total	27-39	1.4-5.4	-	-	-	27-39	-	-	27-39	Drying bed	30-40	0.07-0.13		
<i>Conventional activated sludge</i>														
• Primary sludge	35-45	2-6	35-45	Gravity	4-8	25-28	Anaerobic	4-8	25-28	-	-	-		
• Secondary sludge	25-35	0.6-1	25-35	Gravity Flotation Centrifuge	2-3 2-5 3-7	16-22	Aerobic	1,5-4	16-22	-	-	-		
• Mixed sludge	60-80	1-2	60-80	Gravity Centrifuge	3-7 4-8	38-50	Anaerobic	3-6	38-50	Drying bed Filter press Centrifuge Belt press	30-40 25-35 20-30 20-25	0.10-0.17 0.11-0.20 0.13-0.25 0.15-0.25		

(Continued)

Table 47.2 (Continued)

Wastewater treatment system	Sludge removed from the liquid phase			Thickened sludge			Digested sludge			Dewatered sludge			Per-capita volume (L/inhabitant-d)
	Sludge mass (gSS/inhabitant-d)	Dry solids conc. (%)	Dry solids conc. (%)	Sludge mass (gSS/inhabitant-d)	Thickening process	Dry solids conc. (%)	Sludge mass (gSS/inhabitant-d)	Digestion process	Dry solids conc. (%)	Sludge mass (gSS/inhabitant-d)	Dewatering process	Dry solids conc. (%)	
<i>Activated sludge - extended aeration</i>	40-45	0.8-1.2	2-3	40-45	Gravity	2-3	-	-	-	40-45	Drying bed	25-35	0.11-0.17
			3-6		Flotation	3-6					Filter press	20-30	0.13-0.21
			3-6		Centrifuge	3-6					Centrifuge	15-20	0.19-0.29
											Belt press	15-20	0.19-0.29
<i>High rate trickling filter</i>													
• Primary sludge	35-45	2-6	4-8	35-45	Gravity	4-8	-	-	-	-	-	-	-
• Secondary sludge	20-30	1-2.5	1-3	20-30	Gravity	1-3	-	-	-	-	-	-	-
• Mixed sludge	55-75	1.5-4	3-7	55-75	Gravity	3-7	38-47	Anaerobic	3-6	38-47	Drying bed	30-40	0.09-0.15
											Filter press	25-35	0.10-0.18
											Centrifuge	20-30	0.12-0.22
											Belt press	20-25	0.14-0.22
<i>Submerged aerated biofilter</i>													
• Primary sludge	35-45	2-6	4-8	35-45	Gravity	4-8	25-28	Anaerobic	4-8	-	-	-	-
• Secondary sludge	25-35	0.6-1	2-3	25-35	Gravity	2-3	16-22	Aerobic	1.5-4	-	-	-	-
					Flotation	2-5							
					Centrifuge	3-7							
• Mixed sludge	60-80	1-2	3-7	60-80	Gravity	3-7	38-50	Anaerobic	3-6	38-50	Drying bed	30-40	0.10-0.17
			4-8		Centrifuge	4-8					Filter press	25-35	0.11-0.20
											Centrifuge	20-30	0.13-0.25
											Belt press	20-25	0.15-0.25
<i>UASB Reactor</i>	12-18	3-6	-	-	-	-	12-18	-	-	12-18	Drying bed	30-45	0.03-0.06
											Filter press	25-40	0.03-0.07
											Centrifuge	20-30	0.04-0.09
											Belt press	20-30	0.04-0.09

UASB + activated sludge

• Anaerobic sludge (UASB)	12–18	3–4	–	–	–	–
• Aerobic sludge (activated sludge) (*)	8–14	3–4	–	–	–	–
• Mixed sludge (*)	20–32	3–4	–	–	20–32	Drying bed 30–45 Filter press 25–40 Centrifuge 20–30 Belt press 20–30

UASB + aerobic biofilm reactor

• Anaerobic sludge (UASB)	12–18	3–4	–	–	–	–
• Aerobic sludge (aerobic reactor) (*)	6–12	3–4	–	–	–	–
• Mixed sludge (*)	18–30	3–4	–	–	18–30	Drying bed 30–45 Filter press 25–40 Centrifuge 20–30 Belt press 20–30

Remarks:

- Expression of values on a daily basis does not imply that the sludge is removed, treated and disposed of every day (see Table 5.2 for the sludge removal intervals)
- Solids capture in each stage of the sludge treatment has not been considered in the table. Non-captured solids are assumed to be returned to the system as supernatants, drained liquids and filtrates. Solids capture must be considered during mass balance computations and when designing each stage of the sludge treatment (solids capture percentage is the percentage of the influent solids load to a particular unit that leaves with the sludge, going to the next stage of solids treatment) (see Section 47.3.d).
- Solids are converted to gases and water during digestion process, which reduces the solids load. In the anaerobic digestion of the activated sludge and trickling filter sludge, the so-called secondary digester has the sole purpose of storage and solids – liquid separation, and do not remove volatile solids.
- Litres of sludge/inhabitant-d = [(gSS/inhabitant-d)/(dry solids (%))] × (100/1.050) (assuming 1050 kg/m³ as the density of the dewatered sludge).

(*) Surplus aerobic sludge flows back to UASB undergoing thickening and digestion with the anaerobic sludge.

Sources: Qasim (1985), Metcalf and Eddy (1991), Jordão and Pessoa (1995), Chemicharo (1997), Atisse *et al.* (1999), Gonçalves (1999)

the sludge load is shown on a *per-capita* basis. In the last column, the per-capita daily volume of sludge to be disposed of is presented.

Example 47.1

For a 100,000-inhabitant wastewater treatment plant composed by an UASB reactor, estimate the amount of sludge in each stage of its processing.

Solution:

(a) *Sludge removed from the UASB reactor, to be directed to the sludge treatment stage*

Tables 47.1 and 47.2 show that the per capita sludge mass production varies from 12 to 18 gSS/inhabitant·d, whereas the per capita volumetric production is around 0.2 to 0.6 L/inhabitant·d for sludge withdrawn from UASB reactors. Assuming intermediate values in each range, one has the following total sludge production to be processed:

$$\begin{aligned} \text{SS load in sludge: } & 100,000 \text{ inhabitants} \times 15 \text{ g/inhabitant}\cdot\text{d} \\ & = 1,500,000 \text{ gSS/d} = 1,500 \text{ kgSS/d} \end{aligned}$$

$$\text{Sludge flow: } 100,000 \text{ inhabitants} \times 0.4 \text{ L/inhabitant}\cdot\text{d} = 40,000 \text{ L/d} = 40 \text{ m}^3/\text{d}$$

Should one wish to compute the sludge production as a function of the applied COD load, the following information from Table 47.1 could be used: (a) sludge mass production: 0.12 to 0.18 kgSS/kg applied COD; (b) per capita COD production: around 0.1 kgCOD/inhabitant·d. Assuming an intermediate value for the sludge production range:

$$\begin{aligned} \text{Sludge SS load: } & 100,000 \text{ inhabitants} \times 0.1 \text{ kgCOD/inhabitant}\cdot\text{d} \\ & \times 0.15 \text{ kgSS/kgCOD} = 1,500 \text{ kgSS/d} \end{aligned}$$

This value is identical to the one calculated above, based on the per-capita SS production.

(b) *Dewatered sludge, to be sent to final disposal*

As shown in Table 5.2, the surplus sludge removed from UASB reactors is already thickened and digested, requiring only dewatering prior to final disposal as dry sludge.

In this example, it is assumed that the dewatering is accomplished in sludge drying beds. Table 47.2 shows that the per capita mass production of dewatered sludge remains in the range of 12 to 18 gSS/inhabitant·d, whereas the per capita volumetric production is reduced to the range of 0.03 to 0.06 L/inhabitant·d. Using average values, the total sludge production to be disposed of is:

$$\begin{aligned} \text{SS load in sludge: } & 100,000 \text{ inhabitants} \times 15 \text{ g/inhabitant}\cdot\text{d} \\ & = 1,500,000 \text{ gSS/d} = 1,500 \text{ kgSS/d} \end{aligned}$$

$$\text{Sludge flow: } 100,000 \text{ inhabitants} \times 0.04 \text{ L/inhabitant}\cdot\text{d} = 4,000 \text{ L/d} = 4 \text{ m}^3/\text{d}$$

This is the volume to be sent for final disposal. Assuming a specific weight of 1.05, the total sludge mass (dry solids + water) to go for final disposal is $4 \times 1.05 = 4.2 \text{ ton/d}$.

Example 47.2

For a 100,000-inhabitant conventional activated sludge plant compute the amount of sludge in each stage of the sludge treatment.

Solution:

(a) *Sludge removed from the activated sludge system, to be directed to the sludge treatment stage*

The activated sludge system produces primary and secondary sludge. The estimate of their production can be obtained from Tables 47.1 and 47.2:

Sludge mass production:

- Primary sludge: 35 to 45 gSS/inhabitant·d
- Secondary sludge: 25 to 35 gSS/inhabitant·d
- Mixed sludge (total production): 60 to 80 gSS/inhabitant·d

Sludge volume production:

- Primary sludge: 0.6 to 2.2 L/inhabitant·d
- Secondary sludge: 2.5 to 6.0 L/inhabitant·d
- Mixed sludge (total production): 3.1 to 8.2 L/inhabitant·d

Assuming average figures in each range:

Sludge mass production:

- Primary sludge: $100,000 \text{ inhabitants} \times 40 \text{ gSS/inhabitant}\cdot\text{d} = 4,000,000 \text{ gSS/d} = 4,000 \text{ kgSS/d}$
- Secondary sludge: $100,000 \text{ inhabitants} \times 30 \text{ gSS/inhabitant}\cdot\text{d} = 3,000,000 \text{ gSS/d} = 3,000 \text{ kgSS/d}$
- Mixed sludge (production total): $4,000 + 3,000 = 7,000 \text{ kgSS/d}$

Sludge volume production:

- Primary sludge: $100,000 \text{ inhabitants} \times 1.5 \text{ L/inhabitant}\cdot\text{d} = 150,000 \text{ L/d} = 150 \text{ m}^3/\text{d}$
- Secondary sludge: $100,000 \text{ inhabitants} \times 4.5 \text{ L/inhabitant}\cdot\text{d} = 450,000 \text{ L/d} = 450 \text{ m}^3/\text{d}$
- Mixed sludge (production total): $150 + 450 = 600 \text{ m}^3/\text{d}$

(b) *Thickened mixed sludge*

The mass production of the mixed sludge remains unchanged after thickening (see Table 47.2), so:

Thickened sludge: 7,000 kgSS/d

(c) *Digested mixed sludge*

Volatile solids are partially removed by digestion, therefore reducing the total mass of dry solids. From Table 47.2, the production of anaerobically digested

Example 47.2 (Continued)

mixed sludge is between 38 and 50 gSS/inhabitant-d. Assuming an average figure:

$$\begin{aligned} \text{Mixed digested sludge: } & 100,000 \text{ inhabitants} \times 45 \text{ gSS/inhabitant-d} \\ & = 4,500,000 \text{ gSS/d} = 4,500 \text{ kgSS/d} \end{aligned}$$

It should be noted that the total mass of solids is reduced from 7,000 kgSS/d to 4,500 kgSS/d.

(d) Dewatered mixed sludge

Sludge dewatering does not change the total solids load (see Table 47.2). Therefore, the total mass production is:

$$\text{Dewatered sludge} = 4,500 \text{ kgSS/d}$$

The sludge volume underwent large reductions in the dewatering and thickening processes. For a centrifuged dewatered sludge, Table 47.2 gives the per capita production of 0.13 to 0.25 L/inhabitant-d. Adopting an intermediate value of 0.20 L/inhabitant-d, one has:

$$\begin{aligned} \text{Dewatered sludge} &= 100,000 \text{ inhabitants} \times 0.20 \text{ L/inhabitant-d} \\ &= 20,000 \text{ L/d} = 20 \text{ m}^3/\text{d} \end{aligned}$$

This is the sludge volume to be disposed of. It is seen that the final sludge production from the conventional activated sludge system is much larger than that from the UASB reactor (Example 47.1).

Note: For the sake of simplicity, in both examples the solids capture efficiency at each of the different sludge treatment stages was not taken into account. The solids capture efficiency adopted was 100%. For the concept of solids capture see Section 47.3.d.

47.3 FUNDAMENTAL RELATIONSHIPS IN SLUDGE

To express the characteristics of the sludge, as well as the production in terms of mass and volume, it is essential to have an understanding of some fundamental relationships. The following important items have been already presented in Section 5.2, and the reader is referred to this section to be able to understand the remainder of the present chapter:

- relationship between solid levels and water content
- expression of the concentration of dry solids
- relation between flow, concentration and load

Additional items covered in the current section are:

- total, volatile and fixed solids
- sludge density

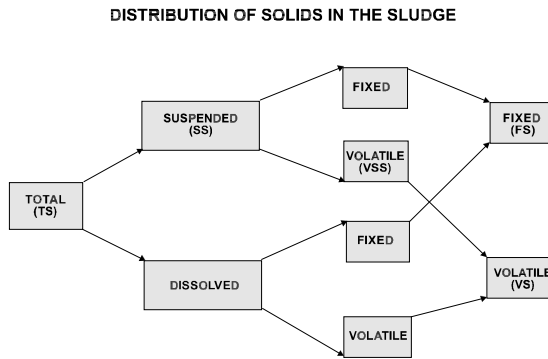

Figure 47.1. Sludge solids distribution according to size and organic fraction

- destruction of volatile solids
- solids capture

(a) Total, volatile and fixed solids

Sludge consists of solids and water. Total solids (TS) may be divided into suspended solids (SS) and dissolved solids. Most sludge solids are represented by suspended solids. Both suspended and dissolved solids may be split into inorganic or fixed solids (FS) and organic or volatile solids (VS). Figure 47.1 illustrates the distribution of the solids according to these different forms.

The ratio of volatile to total solids (VS/TS) gives a good indication of the organic fraction in the sludge solids, as well as its level of digestion. VS/TS ratio for undigested sludges ranges from 0.75 to 0.80, whereas for digested sludges the range is from 0.60 to 0.65. Table 47.3 presents typical ranges of VS/TS for sludges from different wastewater treatment processes.

In this part of the book, when calculating the solids load along the sludge treatment line, the expressions *dry solids*, *total solids* and even *suspended solids* (admitting that the majority of total solids of the sludge is suspended solids) are being used interchangeably.

(b) Density and specific gravity of the sludge

The specific gravity of the fixed solids particles is approximately 2.5 (Crites and Tchobanoglous, 2000), whereas for volatile solids the specific gravity is approximately 1.0. For water, the value is, of course, 1.0. The density of the sludge (water plus solids) depends upon the relative distribution among those three components.

The specific gravity of the *sludge solids* can be estimated by (Metcalf and Eddy, 1991; Crites and Tchobanoglous, 2000):

$$\text{Specific gravity of solids} = \frac{1}{\left(\frac{(FS/TS)}{2.5} + \frac{(VS/TS)}{1.0} \right)} \quad (47.1)$$

Table 47.3. Density, specific gravity, VS/TS ratio and percentage of dry solids for various sludge types

Types of sludge	VS/ST Ratio	% dry solids	Specific gravity of solids	Specific gravity of sludge	Density of sludge (kg/m ³)
<i>Primary sludge</i>	0.75–0.80	2–6	1.14–1.18	1.003–1.01	1003–1010
<i>Secondary anaerobic sludge</i>	0.55–0.60	3–6	1.32–1.37	1.01–1.02	1010–1020
<i>Secondary aerobic sludge (conv. AS)</i>	0.75–0.80	0.6–1.0	1.14–1.18	1.001	1001
<i>Secondary aerobic sludge (ext. aer.)</i>	0.65–0.70	0.8–1.2	1.22–1.27	1.002	1002
<i>Stabilisation pond sludge</i>	0.35–0.55	5–20	1.37–1.64	1.02–1.07	1020–1070
<i>Primary thickened sludge</i>	0.75–0.80	4–8	1.14–1.18	1.006–1.01	1006–1010
<i>Second thickened sludge (conv. AS)</i>	0.75–0.80	2–7	1.14–1.18	1.003–1.01	1003–1010
<i>Second thickened sludge (ext. aer.)</i>	0.65–0.70	2–6	1.22–1.27	1.004–1.01	1004–1010
<i>Thickened mixed sludge</i>	0.75–0.80	3–8	1.14–1.18	1.004–1.01	1004–1010
<i>Digested mixed sludge</i>	0.60–0.65	3–6	1.27–1.32	1.007–1.02	1007–1020
<i>Dewatered sludge</i>	0.60–0.65	20–40	1.27–1.32	1.05–1.1	1050–1100

Notes:

For specific gravity of solids use Equation 47.1; for specific gravity of sludge use Equation 47.2
 AS = activated sludge; ext. aer. = extended aeration activated sludge

On its turn, the specific gravity of the *sludge* (water plus solids) can be estimated as follows:

specific gravity of sludge

$$= \frac{1}{\left(\frac{\text{Solids fraction in sludge}}{\text{Sludge density}} + \frac{\text{Water fraction in sludge}}{1.0} \right)} \quad (47.2)$$

The solids fraction in the sludge corresponds to the dry solids (total solids), expressed in decimals, whereas the water fraction in the sludge corresponds to the moisture, also expressed in decimals (and not in percentage).

Applying the above relationships, one obtains the density and specific gravity of solids and sludges presented in Table 47.3, for different types of sludges.

Table 47.3 shows that the sludge densities are very close to the water density. Nevertheless, it should be noted that some authors indicate slightly higher densities than those from Table 47.3, which have been computed following the above procedure. Usual values reported are presented in Table 47.4.

(c) Destruction of volatile solids

Digestion removes biodegradable organic solids from the sludge. Hence, it can be said that there was a removal or destruction of volatile solids (VS). The quantity

Table 47.4. Usual values of sludge densities

Type of sludge	Specific gravity	Density (kg/m ³)
<i>Primary sludge</i>	1.02–1.03	1020–1030
<i>Secondary anaerobic sludge</i>	1.02–1.03	1020–1030
<i>Secondary aerobic sludge</i>	1.005–1.025	1005–1025
<i>Thickened sludge</i>	1.02–1.03	1020–1030
<i>Digested sludge</i>	1.03	1030
<i>Dewatered sludge</i>	1.05–1.08	1050–1080

of fixed solids (FS) remains unchanged. Typical efficiencies of VS removal in digestion are:

$$E = 0.40 \text{ to } 0.55 \text{ (40 to 55\%)}$$

The solids load (kg/d) before and after digestion can be computed from:

$$TS_{\text{influent}} = VS_{\text{influent}} + FS_{\text{influent}} \quad (47.3)$$

$$TS_{\text{effluent}} = (1 - E) \times VS_{\text{influent}} + FS_{\text{influent}} \quad (47.4)$$

(d) Solids capture

In the sludge treatment stages in which there is solids–liquid separation (e.g., thickening and dewatering), not all solids are separated from the liquid and go to the subsequent stage of the sludge treatment. A part of these solids remain in the supernatants, drained outflows and filtrates of the separation units. Because of these remaining solids (particulate BOD), these flows must be returned to the head of the works to be mixed with the plant influent and undergo additional treatment.

The incorporation of solids to sludge is known as *solids capture* (or *solids recovery*). It is expressed usually as a percentage (%), aiming to depict the efficiency of incorporation of solids to the sludge that will be sent to the subsequent stages of the processing.

Therefore, the solids loads (kgSS/d) are:

$$\text{Effluent SS load in sludge} = \text{Solids capture} \times \text{Influent SS load in sludge} \quad (47.5)$$

$$\text{SS load in drained liquid} = (1 - \text{Solids capture}) \times \text{Influent SS load in sludge} \quad (47.6)$$

For example, if a SS load of 100 kgSS/d goes through a 90% solids capture efficiency sludge treatment unit, then 90 kgSS/d ($= 0.9 \times 100 \text{ kgSS/d}$) will flow with the sludge towards the subsequent treatment stages, and 10 kgSS/d ($= (1 - 0.9) \times 100 \text{ kgSS/d}$) will be incorporated to the drained liquid and be sent back to the head of the wastewater treatment plant.

Typical values of solids capture in sludge treatment are presented in Table 47.5.

Table 47.5. Ranges of solids captures in sludge treatment

Type of sludge	Thickening		Digestion		Dewatering	
	Process	Capture (%)	Process	Capture (%)	Process	Capture (%)
Primary sludge	Gravity	85–92	Second. digester	95	Drying bed	90–98
					Filter press	90–98
					Centrifuge	90–95
					Belt press	90–95
Secondary sludge	Gravity	75–85	Second. digester	90–95	Drying bed	90–98
	Flotation	80–95			Filter press	90–98
	Centrifuge	80–95			Centrifuge	90–95
					Belt press	90–95
Mixed sludge	Gravity	80–90	Second. digester	90–95	Drying bed	90–98
		85–95			Filter press	90–98
	Centrifuge	85–95			Centrifuge	90–95
					Belt press	90–95

Note: The *secondary* anaerobic digester merely works as a sludge holder and solids–liquid separator. The *primary* anaerobic digester has 100% solids capture, because all solids (as well as liquid) are sent to the secondary digester. The *aerobic* digester has also 100% capture, with no further storage stage.
Source: Adapted from Qasim (1985) and EPA (1987)

47.4 CALCULATION OF THE SLUDGE PRODUCTION

47.4.1 Primary sludge production

The sludge production in primary treatment (primary sludge) depends on the SS removal efficiency in the primary clarifiers. This efficiency can be also understood as solids capture. Typical SS removal (capture) efficiencies in *primary clarifiers* are as follows:

$$\text{SS removal efficiency in primary clarifiers: } E = 0.60 \text{ to } 0.65 \text{ (60 to 65\%)}$$

Therefore, the load of primary sludge produced is:

$$\text{SS load from primary sludge} = E \times \text{Influent SS load}$$

$$\text{SS load from primary sludge} = E \cdot Q \cdot \text{Influent SS conc} \quad (47.7)$$

The SS load direct to the biological treatment is:

$$\text{Influent SS load to biological treatment} = (1 - E) \cdot Q \cdot \text{Influent SS conc} \quad (47.8)$$

The volumetric production of the primary sludge can be estimated from Equation 5.5, and the TS concentration and specific gravity of the sludge from Table 47.4.

Example 47.4 shows an estimate of primary sludge production, as well as the transformations in sludge load and volume that take place throughout the various sludge treatment units.

47.4.2 Secondary sludge production

Secondary (biological) sludge production is estimated considering kinetic and stoichiometric coefficients of the particular biological wastewater treatment process being used. The following fractions make up the sludge produced:

- Biological solids: biological solids produced in the system as a result of the organic matter removal.
- Inert solids from raw sewage: non-biodegradable solids, accumulated in the system.

The *net* production of biological solids corresponds to the *total* production (synthesis, or anabolism) minus *mortality* (decay, or catabolism).

Various chapters in this book present an estimate of the total sludge production in their respective wastewater treatment process following the preceding methodology. Therefore, further details should be obtained in these chapters. Approximate figures for sludge productions can be derived from Tables 5.2, 47.1 and 47.2, whereas typical sludge removal frequencies are presented in Table 5.2.

In the estimation of the amount of biological sludge to be treated, a fraction may be deducted from the total amount produced. This fraction corresponds to the amount lost with the final effluent (solids that unintentionally escape with the final effluent, due to the fact that the SS removal efficiencies are naturally lower than 100% in the final clarifiers). If this refinement in the calculation is incorporated, it should be understood that the load of solids to be treated is equal to the load of solids produced minus the load of solids escaping with the final effluent.

Example 47.3 shows the estimation of the sludge production from an UASB reactor, whereas Example 47.4 computes the primary and secondary sludge production from an activated sludge system. Sludge load and volume variations along the sludge treatment are also quantified in both examples.

Example 47.3

Estimate the sludge flow and concentration and the SS load in each stage of the sludge processing at a treatment plant composed by an UASB reactor, treating the wastewater from 20,000 inhabitants. Use the pertinent data from the design example at Chapter 27.

The sludge treatment flowsheet is made up of:

- Type of sludge: secondary sludge (withdrawn from the UASB reactor)
- Sludge dewatering: natural (drying beds)

Data from the example in Chapter 27:

- Population: 20,000 inhabitants
- Average influent flow: $Q = 3,000 \text{ m}^3/\text{d}$
- Concentration of influent COD: $S_0 = 600 \text{ mg/L}$
- Solids production coefficient: $Y = 0.18 \text{ kgSS/kgCOD}_{\text{applied}}$
- Expected concentration of the excess sludge: 4%
- Sludge density: 1020 kg/m^3

Example 47.3 (Continued)**Solution:**

(a) *Sludge generated in the UASB reactor (influent to the dewatering stage)*

$$\begin{aligned}\text{COD load applied} &= 3,000 \text{ m}^3/\text{d} \times 600 \text{ g/m}^3 \\ &= 1,800,000 \text{ gCOD/d} = 1,800 \text{ kgCOD/d} \\ \text{Sludge production: } P &= 0.18 \text{ kgSS/kgCOD}_{\text{applied}} \times 1,800 \text{ kgCOD/d} \\ &= 324 \text{ kgSS/d}\end{aligned}$$

Sludge flow (Equation 5.5):

$$\begin{aligned}\text{Sludge flow (m}^3/\text{d)} &= \frac{\text{SS load (kgSS/d)}}{\frac{\text{Dry solids (\%)}}{100} \times \text{Sludge density (kg/m}^3\text{)}} \\ &= \frac{324 \text{ kgSS/d}}{\frac{4}{100} \times 1,020 \text{ kg/m}^3} = 7.94 \text{ m}^3/\text{d}\end{aligned}$$

This is the same value obtained in the referred to example. In case the simplified Equation 5.6 had been used, it would result in a sludge flow of 8.1 m³/d, which is very close to the value calculated above.

The per capita productions are:

- Per capita SS load = 324 kgSS/d/20,000 inhabitants = 16 gSS/inhabitant·d
- Per capita flow = 7.94 m³/d/20,000 inhabitants = 0.40 L/inhabitant·d

These values are within the per capita ranges presented in Table 47.1.

(b) *Effluent sludge from dewatering (sludge for final disposal)*

Since the excess sludge from the UASB reactor is already digested and thickened, only dewatering before final disposal is required.

In case the sludge is dewatered using drying beds, its dry solids content is between 30% to 45% (see Table 47.2), its density is in the range from 1050 to 1080 kg/m³ (Table 47.4) and the solids capture is between 90% to 98% (see Table 47.5). In this example, the following values are adopted:

- SS concentration in the dewatered sludge: 40%
- density of the dewatered sludge: 1,060 kg/m³
- solids capture in the dewatering stage: 95%

The solids captured and incorporated to the dewatered sludge can be calculated from Equation 47.5:

$$\begin{aligned}\text{Effluent SS load (kgSS/d)} &= \text{Solids capture} \times \text{SS influent load (kgSS/d)} \\ &= 0.95 \times 324 \text{ kgSS/d} = 308 \text{ kgSS/d}\end{aligned}$$

Example 47.3 (Continued)

The daily volume of dewatered sludge (cake) to go for final disposal can be estimated by Equation 5.5:

$$\begin{aligned}\text{Sludge flow (m}^3\text{/d)} &= \frac{\text{SS load (kgSS/d)}}{\frac{\text{Dry solids (\%)}}{100} \times \text{Sludge density (kg/m}^3\text{)}} \\ &= \frac{308 \text{ kgSS/d}}{\frac{40}{100} \times 1060 \text{ kg/m}^3} = 0.73 \text{ m}^3\text{/d}\end{aligned}$$

The per capita productions are:

- Per capita SS load = 308 kgSS/d/20,000 inhabitants = 15.4 gSS/inhabitant-d
- Per capita flow = 0.73 m³/d/20,000 inhabitants = 0.04 L/inhabitant-d

These values are within the per capita ranges presented in Table 47.2.

(c) Filtrate from dewatering (returned to the head of the WWTP)

The solids load that is incorporated to the drying bed filtrate liquid and returns to the head of the WWTP may be computed from Equation 47.6:

$$\begin{aligned}\text{SS load in filtrate (kgSS/d)} &= (1 - \text{Solids capture}) \times \text{Influent SS load (kgSS/d)} \\ &= (1 - 0.95) \times 324 \text{ kgSS/d} = 16 \text{ kgSS/d}\end{aligned}$$

The flow of the filtrate from the drying beds (without consideration of evaporation, for the sake of simplicity in this example) is the difference between the influent and effluent sludge flows:

$$\begin{aligned}\text{Filtrate flow} &= \text{Influent sludge flow} - \text{Effluent sludge flow} \\ &= 7.94 - 0.73 = 7.21 \text{ m}^3\text{/d}\end{aligned}$$

The filtrate solids concentration is the SS load divided by the filtrate flow (the filtrate and water densities are assumed to be equal):

$$\begin{aligned}\text{SS conc} &= \frac{\text{SS load}}{\text{Flow}} = \frac{16 \text{ kgSS/d} \times 1,000 \text{ g/kg}}{7.21 \text{ m}^3\text{/d}} \\ &= 2,219 \text{ g/m}^3 = 2,219 \text{ mg/L} = 0.22\%\end{aligned}$$

The preceding solids load can be taken into account in the computation of the influent load to the UASB reactor.

Example 47.4

Estimate the sludge flow and concentration and the SS load in each stage of the sludge processing at a treatment plant composed by a conventional activated sludge plant, treating the wastewater from 62,000 inhabitants. Use the pertinent data from the design example at Chapter 34.

The sludge treatment flowsheet is made up of:

- Types of sludge: primary and secondary (mixed when entering the sludge treatment)
- Type of sludge thickening: gravity
- Type of sludge digestion: primary and secondary anaerobic digesters
- Type of sludge dewatering: mechanical (centrifuge)

Pertinent data from the referred to example:

- Population: 67,000 inhabitants
- Average influent flow: $Q = 9,820 \text{ m}^3/\text{d}$
- Influent SS load: $3,720 \text{ kg}/\text{d}$
- Influent SS concentration: $\text{SS} = 379 \text{ mg}/\text{L}$
- SS removal efficiency in the primary clarifier: 60% (assumed)

Data related to the production of secondary sludge (from the referred to example):

- Place of removal of excess sludge: return sludge line
- SS load to be removed: $1,659 \text{ kgSS}/\text{d}$
- SS concentration in excess sludge: $7,792 \text{ mg}/\text{L}$ (0.78%)
- Excess sludge flow: $Q_{\text{ex}} = 213 \text{ m}^3/\text{d}$

Solution:

(a) *Sludge removed from the primary clarifier (primary sludge)*

SS load removed from primary clarifier:

$$\begin{aligned} \text{Removed SS load} &= \text{Removal efficiency} \times \text{Influent SS load} \\ &= 0.60 \times 3,720 \text{ kgSS}/\text{d} = 2,232 \text{ kgSS}/\text{d} \end{aligned}$$

The characteristics of the removed primary sludge are: dry solids content from 2% to 6% (see Tables 47.2 and 47.3) and sludge density from 1020 to 1030 kg/m^3 (Table 47.3). The values adopted for the present example are:

- SS concentration in primary sludge: 4%
- Primary sludge density: $1020 \text{ kg}/\text{m}^3$

Example 47.4 (Continued)

The flow of primary sludge that goes for thickening is estimated by Equation 5.5:

$$\begin{aligned} \text{Sludge flow (m}^3\text{/d)} &= \frac{\text{SS load (kgSS/d)}}{\frac{\text{Dry solids (\%)}}{100} \times \text{Sludge density (kg/m}^3\text{)}} \\ &= \frac{2,232 \text{ kgSS/d}}{\frac{40}{100} \times 1020 \text{ kg/m}^3} = 54.7 \text{ m}^3\text{/d} \end{aligned}$$

The per capita primary sludge productions are:

- Per capita SS load = 2,232 kgSS/d/67,000 inhabitants = 33 gSS/inhabitant-d
- Per capita sludge flow = 54.7 m³/d/67,000 inhabitants = 0.82 L/inhabitant-d

These values are within the lower range of per capita values presented in Table 47.1.

(b) Secondary sludge

The amount of secondary sludge to be removed from the activated sludge system was calculated in Chapter 34, and it is now an input data for the present example (see above):

- Place of removal of excess sludge: return sludge line
- SS load to be removed: 1,659 kgSS/d
- SS concentration in excess sludge: 7,792 mg/L (0.78%)
- Excess sludge flow: $Q_{\text{ex}} = 213 \text{ m}^3\text{/d}$

The per capita secondary sludge productions are:

- Per capita SS load = 1,659 kgSS/d/67,000 inhabitants = 25 gSS/inhabitant-d
- Per capita sludge flow = 213 m³/d/67,000 inhabitants = 3.18 l/inhabitant-d

These values are within the lower range of per capita values of Table 47.1

(c) Mixed sludge (primary sludge + secondary sludge) (influent sludge to the thickener)

Primary and secondary sludges are mixed before entering the thickener.

SS load in mixed sludge is:

$$\begin{aligned} \text{Mixed sludge SS load} &= \text{Primary sludge SS load} + \text{Secondary sludge SS load} \\ &= 2,232 + 1,659 = 3,891 \text{ kgSS/d} \end{aligned}$$

Example 47.4 (Continued)

The mixed sludge flow is:

$$\begin{aligned}\text{Mixed sludge flow} &= \text{Primary sludge flow} + \text{Secondary sludge flow} \\ &= 54.7 + 213.0 = 267.7 \text{ m}^3/\text{d}\end{aligned}$$

The solids concentration in the mixed sludge is the SS load divided by the sludge flow (considering the mixed sludge density equal to the water density):

$$\begin{aligned}\text{SS conc} &= \frac{\text{SS load}}{\text{Flow}} = \frac{3,891 \text{ kgSS/d} \times 1,000 \text{ g/kg}}{267.7 \text{ m}^3/\text{d}} \\ &= 14,535 \text{ g/m}^3 = 14,535 \text{ mg/L} = 1.45\%\end{aligned}$$

(d) Thickened effluent sludge (sludge to be sent to the digester)

The effluent sludge from the thickener has a solids load equal to the influent load multiplied by the solids capture. From Table 47.5, it is seen that the solids capture for gravity thickening of primary plus secondary sludge is between 80% and 90%. Assuming 85% solids capture, the effluent SS load from the thickener is (Equation 47.5):

$$\begin{aligned}\text{SS effluent load} &= \text{Solids capture} \times \text{Influent load} \\ &= 0.85 \times 3,891 \text{ kg/d} = 3,307 \text{ kgSS/d}\end{aligned}$$

The mixed sludge thickened by gravity has the following characteristics: dry solids content between 3% and 7% (see Table 47.2), and sludge density from 1,020 to 1,030 kg/m³ (see Table 47.4). The following values are adopted in the present example:

- SS concentration in thickened sludge: 5%
- Density of thickened sludge: 1,030 kg/m³

The thickened sludge flow going to digestion is estimated by Equation 5.5:

$$\begin{aligned}\text{Sludge flow (m}^3/\text{d)} &= \frac{\text{SS load (kgSS/d)}}{\frac{\text{Dry solids (\%)}}{100} \times \text{Sludge density (kg/m}^3\text{)}} \\ &= \frac{3,307 \text{ kgSS/d}}{\frac{5}{100} \times 1,030 \text{ kg/m}^3} = 64.2 \text{ m}^3/\text{d}\end{aligned}$$

(e) Thickener supernatant (returned to the head of the treatment plant)

The SS load in the thickener supernatant is:

$$\begin{aligned}\text{Supernatant SS load} &= \text{Influent SS load} - \text{Effluent sludge SS load} \\ &= 3,891 - 3,307 = 584 \text{ kgSS/d}\end{aligned}$$

Example 47.4 (Continued)

The thickener supernatant flow is:

$$\begin{aligned}\text{Supernatant flow} &= \text{Influent flow} - \text{Effluent sludge flow} \\ &= 267.7 - 64.2 = 203.5 \text{ m}^3/\text{d}\end{aligned}$$

The SS concentration in the supernatant is:

$$\begin{aligned}\text{SS conc} &= \frac{\text{SS load}}{\text{Flow}} = \frac{584 \text{ kgSS/d} \times 1,000 \text{ g/kg}}{203.5 \text{ m}^3/\text{d}} \\ &= 2,870 \text{ g/m}^3 = 2,870 \text{ mg/L} = 0.29\%\end{aligned}$$

(f) *Effluent sludge from primary digester (influent sludge to secondary digester)*

The VS/TS ratio in the thickened mixed sludge is between 0.75 to 0.80 (see Table 47.3). In the present example, the value of 0.77 has been adopted. The distribution of the TS influent load to digestion, considering 77% as volatile solids and 23% as fixed solids, is:

- TS influent = 3,307 kgTS/d
- VS influent = (VS/TS) × TS influent = 0.77 × 3,307 = 2,546 kgVS/d
- FS influent = (1 - VS/TS) × TS influent = (1 - 0.77) × 3,307 = 761 kgFS/d

After digestion, the FS remain unaltered, but the VS are partially removed. According to Section 47.3.c, the removal efficiency of VS in anaerobic digesters is between 40% and 55%. For the present example, 50% (0.50) removal was assumed.

The distribution of the solids load from the effluent from the primary digester is:

- FS effluent = FS influent = 761 kgFS/d
- VS effluent = (1 - VS removal efficiency) × VS influent = (1 - 0.50) × 2,546 = 1,273 kgVS/d
- TS effluent = FS effluent + VS effluent = 761 + 1,273 = 2,034 kgTS/d

The distribution of effluent solids from the primary digester is:

- FS/TS effluent = 761/2,034 = 0.37 = 37%
- VS/TS effluent = 1,273/2,034 = 0.63 = 63%

It should be noticed that the VS/TS ratio (77%) in the influent to the digester has been reduced down to 63% after digestion.

The effluent sludge flow from the primary digester is equal to the influent sludge flow. Therefore:

$$\begin{aligned}\text{Primary digester effluent sludge flow} &= \text{Primary digester influent sludge flow} \\ &= 64.2 \text{ m}^3/\text{d}\end{aligned}$$

Example 47.4 (Continued)

The SS concentration in the effluent sludge from the primary digester is:

$$\begin{aligned} \text{SS conc} &= \frac{\text{SS load}}{\text{Flow}} = \frac{2,034 \text{ kgSS/d} \times 1,000 \text{ g/kg}}{64.2 \text{ m}^3/\text{d}} \\ &= 31,682 \text{ g/m}^3 = 31,682 \text{ mg/L} = 3.17\% \end{aligned}$$

It can be seen that the digestion process lead to a reduction of both the solids load and the solids concentration.

(g) Effluent sludge from the secondary digester (sludge to be dewatered)

The secondary digester does not actually digest solids, being simply a sludge holding tank. During the sludge storage, some sedimentation of solids takes place. A supernatant is formed and removed, being returned to the head of the works. The sludge settled in the bottom proceeds to dewatering.

The solids capture in the secondary digester is between 90% and 95% (see Table 47.5). Assuming a solids capture of 95%, the effluent SS load from the secondary digester is:

$$\begin{aligned} \text{Effluent SS load} &= \text{Solids capture} \times \text{Influent load} \\ &= 0.95 \times 2,034 \text{ kg/d} = 1,932 \text{ kgSS/d} \end{aligned}$$

The volatile and fixed solids keep the same relative proportions they had when leaving the primary digester (FS/TS = 37%; VSS/TS = 63%, as computed in item f). The effluent VS and FS loads from the secondary digester are:

- FS effluent load = $0.37 \times 1,932 = 715 \text{ kgFS/d}$
- VS effluent load = $0.63 \times 1,932 = 1,217 \text{ kgVS/d}$

The mixed digested sludge has the following characteristics: dry solids content between 3% and 6% (see Table 47.2), and sludge density around 1030 kg/m^3 (see Table 47.4). The following values are adopted in the present example:

- SS concentration in the effluent sludge from the secondary digester: 4% (this figure must be higher than the SS concentration in the effluent sludge from the primary digester, which was 3.17% in this particular example)
- Density of the effluent sludge from the secondary digester: $1,030 \text{ kg/m}^3$

The effluent sludge flow from the secondary digester sent to dewatering is estimated by Equation 5.5:

$$\begin{aligned} \text{Sludge flow (m}^3/\text{d)} &= \frac{\text{SS load (kgSS/d)}}{\frac{\text{Dry solids (\%)}}{100} \times \text{Sludge density (kg/m}^3\text{)}} \\ &= \frac{1,932 \text{ kgSS/d}}{\frac{4}{100} \times 1,030 \text{ kg/m}^3} = 46.9 \text{ m}^3/\text{d} \end{aligned}$$

Example 47.4 (Continued)

(h) *Supernatant from the secondary digester (returned to the head of the treatment plant)*

The SS load in the secondary digester supernatant is:

$$\begin{aligned}\text{Supernatant SS load} &= \text{Influent SS load} - \text{Effluent SS sludge load} \\ &= 2,034 - 1,932 = 102 \text{ kgSS/d}\end{aligned}$$

The digester supernatant flow is:

$$\begin{aligned}\text{Supernatant flow} &= \text{Influent sludge flow} - \text{Effluent sludge flow} \\ &= 64.2 - 46.9 = 17.3 \text{ m}^3/\text{d}\end{aligned}$$

The SS concentration in the supernatant is:

$$\begin{aligned}\text{SS conc} &= \frac{\text{SS load}}{\text{Flow}} = \frac{102 \text{ kgSS/d} \times 1,000 \text{ g/kg}}{17.3 \text{ m}^3/\text{d}} \\ &= 5,896 \text{ g/m}^3 = 5,896 \text{ mg/L} = 0.59\%\end{aligned}$$

(i) *Dewatered sludge production (sludge for final disposal)*

In the present example, dewatering is accomplished by centrifuges. The solids load due to the polyelectrolytes added to the sludge being centrifuged is not taken into account. It is assumed that the dewatered sludge sent for final disposal does not receive any other chemicals (for instance, lime for disinfection). If lime is added, its solids load is significant and should be taken into consideration (see Chapter 51).

The solids load in the dewatered sludge (sludge cake) is equal to the influent load multiplied by the solids capture. According to Table 47.5, the capture of digested mixed sludge solids through centrifuge dewatering is from 90% to 95%. Assuming 90% solids capture, the effluent SS load from the dewatering stage is (Equation 47.5):

$$\begin{aligned}\text{SS effluent load} &= \text{Solids capture} \times \text{Influent load} \\ &= 0.90 \times 1,932 \text{ kg/d} = 1,739 \text{ kgSS/d}\end{aligned}$$

The mixed sludge dewatered by centrifuges has the following characteristics: dry solids content between 20% and 30% (see Table 47.2) and sludge density between 1,050 and 1,080 kg/m³ (see Table 47.4). The following values are adopted in the present example:

- SS concentration in the dewatered sludge: 25%
- Density of the dewatered sludge: 1,060 kg/m³

Example 47.4 (Continued)

The daily volume (flow) of dewatered sludge sent for final disposal is estimated by Equation 5.5:

$$\begin{aligned} \text{Sludge flow (m}^3\text{/d)} &= \frac{\text{SS load (kgSS/d)}}{\frac{\text{Dry solids (\%)}}{100} \times \text{Sludge density (kg/m}^3\text{)}} \\ &= \frac{1,739 \text{ kgSS/d}}{\frac{25}{100} \times 1,060 \text{ kg/m}^3} = 6.6 \text{ m}^3\text{/d} \end{aligned}$$

The per capita production of mixed dewatered sludge is:

- Per capita SS load = 1,739 kgSS/d/67,000 inhabitants = 26 gSS/inhabitant·d
- Per capita flow = 6.6 m³/d/67,000 inhabitants = 0.10 L/inhabitant·d

These values are below the per capita figures of Table 47.2. However, Table 47.2 does not consider the solids capture efficiency, and assumes 100% capture in each one of the various steps of the sludge treatment, that is, all the influent sludge leaves in the effluent to the next stage of treatment. On the other hand, the present example did not consider the supernatant load, neither the drained solids load (both figures have been computed, but not added as further influent loads to the WWTP). Section 47.5 exemplifies how such returned loads can be incorporated to the general plant mass balance.

(j) Centrate from dewatering (returned to head of the treatment plant)

The SS load present in the centrifuge drained flow (centrate) is:

$$\begin{aligned} \text{Drained SS load} &= \text{Influent SS load} - \text{Effluent sludge SS load} \\ &= 1,932 - 1,739 = 193 \text{ kgSS/d} \end{aligned}$$

The centrifuge drained flow is:

$$\begin{aligned} \text{Drained flow} &= \text{Influent flow} - \text{Effluent sludge flow} \\ &= 46.9 - 6.6 = 40.3 \text{ m}^3\text{/d} \end{aligned}$$

The SS concentration in the drained liquid is:

$$\begin{aligned} \text{SS conc} &= \frac{\text{SS load}}{\text{Flow}} = \frac{193 \text{ kgSS/d} \times 1,000 \text{ g/kg}}{40.3 \text{ m}^3\text{/d}} \\ &= 4,789 \text{ g/m}^3 = 4,789 \text{ mg/L} = 0.48\% \end{aligned}$$

Example 47.4 (Continued)*(k) Summary of loads, flows and concentrations*

Source	Sludge			Supernatant/drained		
	SS load (kgSS/d)	Flow (m ³ /d)	SS concent. (%)	SS load (kgSS/d)	Flow (m ³ /d)	SS concent. (mg/L)
Primary sludge	2,232	54.7	4.00	—	—	—
Secondary sludge	1,659	213.0	0.78	—	—	—
Mixed sludge	3,891	267.7	1.45	—	—	—
Thickener	3,307	64.2	5.0	584	203.5	2870
Primary digester	2,034	64.2	3.2	—	—	—
Secondary digester	1,932	46.9	4.0	102	17.3	5896
Dewatering	1,739	6.6	25.0	193	40.3	4789

The following formulae allow the structuring of the table in a spreadsheet format:

Source	Sludge			Supernatant/drained		
	SS load (kgSS/d)	Flow (m ³ /d)	SS concent. (%)	SS load (kgSS/d)	Flow (m ³ /d)	SS concent. (mg/L)
Primary sludge	(1)	(2)	(3)	—	—	—
Secondary sludge	(4)	(5)	(6)	—	—	—
Mixed sludge	(7)	(8)	(9)	—	—	—
Thickener	(10)	(11)	(12)	(13)	(14)	(15)
Primary digester	(16)	(17)	(18)	—	—	—
Secondary digester	(19)	(20)	(21)	(22)	(23)	(24)
Dewatering	(25)	(26)	(27)	(28)	(29)	(30)

(1) = Clarifier solids capture efficiency × Influent SS load to the primary clarifier

$$(2) = \frac{(1)}{\frac{(3)}{100}} \times \text{Density (kg/m}^3\text{)}$$

(3) = Assumed value

(4) (5) (6) = Calculated values based on activated sludge process kinetics

$$(7) = (1) + (4)$$

$$(8) = (2) + (5)$$

$$(9) = [(7) \times 100] / [(8) \times 1000]$$

(10) = Thickener solids capture efficiency × (7)

$$(11) = \frac{(10)}{\frac{(12)}{100}} \times \text{Density (kg/m}^3\text{)}$$

(12) = Assumed value

Example 47.4 (Continued)

$$(13) = (7) - (10)$$

$$(14) = (8) - (11)$$

$$(15) = (13) \times 1000/(14)$$

$$(16) = [(10) \times (1 - \text{VSS/SS sludge})] + [(10) \times (\text{VSS/SS sludge}) \times \text{VSS removal efficiency}]$$

$$(17) = (11)$$

$$(18) = [(16) \times 100] / [(17) \times 1000]$$

$$(19) = \text{Secondary digester solids capture efficiency} \times (16)$$

$$(20) = \frac{(19)}{\frac{(21)}{100} \times \text{Density (kg/m}^3\text{)}}$$

$$(21) = \text{Assumed value}$$

$$(22) = (16) - (19)$$

$$(23) = (17) - (20)$$

$$(24) = (22) \times 1000/(23)$$

$$(25) = \text{Dewatering solids capture efficiency} \times (19)$$

$$(26) = \frac{(25)}{\frac{(27)}{100} \times \text{Density (kg/m}^3\text{)}}$$

$$(27) = \text{Assumed value}$$

$$(28) = (19) - (25)$$

$$(29) = (20) - (26)$$

$$(30) = (28) \times 1000/(29)$$

47.5 MASS BALANCE IN SLUDGE TREATMENT

As seen on Examples 47.3 and 47.4, supernatant, percolated and drained liquids from the various sludge treatment stages contain suspended solids, since not all influent solids are able to come out with the sludge, because the solids capture efficiency is not 100%. These solids represent organic matter and must return to the sludge treatment plant instead of being discharged to the receiving water body. The fact that these solids are returned to treatment leads to an increase in the influent solids load to the treatment stages in the liquid and solids lines.

If the design of the wastewater treatment plant takes into account the return of these solids in the overall computation of influent and effluent loads, these should be calculated by an iterative process. Three iterations are usually sufficient

to accomplish the convergence of values, that is, the loads from the fourth iteration are very close to those in the third iteration. Example 47.5 clarifies the mass balance to be undertaken.

Example 47.5

For the activated sludge plant of Example 47.4, compute the mass balance for the solid loads. Assume that the supernatant and drained liquids are returned upstream of the primary clarifier. The input data are as follows:

- Influent average flow (m^3/d): 9820
- Influent SS concentration (mg/L): 379
- Secondary excess sludge load (kg/d): 1659

SS capture efficiencies:

- primary clarifier: 0.60
- thickener: 0.85
- secondary digester: 0.95
- dewatering: 0.90

VSS removal efficiency in digestion: 0.50

VSS /SS ratio in influent sludge for digestion: 0.77

Solution:

Iterative spreadsheet for the mass balance

SS loads through sludge treatment, after several iterations (kg/d).

Stage	SS load (kg/d)					
	1	2	Iteration		5	6
PRIMARY CLARIFIER						
Influent	3,720	4,599	4,717	4,734	4,736	4,736
Effluent	1,488	1,839	1,887	1,893	1,894	1,894
Sludge	2,232	2,759	2,830	2,840	2,841	2,842
THICKENER						
Influent	3,891	4,418	4,489	4,499	4,500	4,501
Supernatant	584	663	673	675	675	675
Thickened sludge	3,307	3,755	3,816	3,824	3,825	3,826
PRIMARY DIGESTER						
Influent	3,307	3,755	3,816	3,824	3,825	3,826
Effluent	2,034	2,310	2,347	2,352	2,353	2,353
SECONDARY DIGESTER						
Influent	2,034	2,310	2,347	2,352	2,353	2,353
Supernatant	102	115	117	118	118	118
Digested sludge	1,932	2,194	2,230	2,234	2,235	2,235
DEWATERING						
Influent	1,932	2,194	2,230	2,234	2,235	2,235
Drained	193	219	223	223	223	224
Dewatered sludge	1,739	1,975	2,007	2,011	2,011	2,012

Example 47.5 (Continued)

Notes:

- The values for the first iteration are the same as those calculated in Example 47.4.
- In the second iteration, the influent SS load to the primary clarifier is the influent load of the first iteration (3,720 kg/d), increased by the loads coming from the liquids that return to the plant ($584 + 102 + 193 = 879$ kg/d), leading to a total influent load of 4,599 kg/d ($= 3720 + 879$).
- In the second iteration, the influent load to the thickener is the sludge load from the primary clarifier, increased by the excess activated sludge load (1,659 kg/d). This secondary excess sludge load does not change from one iteration to the next. Actually, it could have been taken into account the fact that the returned solids loads also bring BOD to the system, which would imply an increased secondary excess sludge production. This analysis is beyond the scope of the present example.
- The remaining figures of the second iteration are calculated according to the same methodology used for the first iteration, as shown in Example 47.4.
- The succeeding iterations are done according to the same routine of the second iteration.
- It should be noticed that the values in the third iteration are very close to those of the last iteration, showing that the iterative process could be interrupted in the third iteration without any considerable error.
- The values of the sixth iteration are equal to those of the fifth iteration, indicating that the iterative process can be considered complete.
- It can be seen that the returned loads bring a substantial impact to the mass balance, since the values of the last iteration are higher than those from the first iteration.
- The concentrations and flows can be computed following the procedures presented in Example 47.4.

Main contaminants in sludge

*S.M.C.P. da Silva, F. Fernandes, V.T. Soccol,
D.M. Morita*

48.1 INTRODUCTION

Some constituents of the wastewater, while passing through the treatment system, may increase their concentration in the sludge. Although several organic and mineral constituents in the sludge may have fertilising characteristics, others may not be desirable, due to the associated sanitary and environmental risks. These undesirable constituents can generally be grouped into:

- metals
- trace organic contaminants
- pathogenic organisms

Section 2.2.6 (*Characteristics of industrial wastewater*) covers a description of metals and toxic and dangerous organic compounds. Section 2.2.3.6 addresses pathogenic organisms and indicators of faecal contamination.

Their presence in the sludge is extremely variable depending upon both the raw wastewater characteristics and the treatment system. Wastewaters from healthy populations present substantially less pathogens than those from unhealthy ones. In a similar way, domestic wastewater sludge has low heavy metals content, usually presenting no environmental hazard. Most chemical contaminants in the sludge are a consequence of the discharge of industrial effluents into the sewerage system.

A sound sludge management practice needs to take into account this aspect, which is often disregarded by many water and sanitation companies. A sustainable environmental policy aiming at sludge recycling requires the best economically achievable sludge quality. Water and sanitation companies must have a clear, well-defined and technically based policy of acceptance of non-domestic effluents, which avoids contaminants that could jeopardise the sludge quality and bring about the need of an expensive wastewater treatment.

Agricultural use of wastewater sludge is an acceptable practice when harmful effects can be avoided to soil, agricultural products, human health and the environment. As far as pathogenic organism contamination is concerned, a number of sludge disinfection techniques can be applied in order to reduce the pathogen densities to levels that are acceptable for agricultural use (see Chapter 51). Regarding metals and organic pollutants, there are no economically feasible techniques for their removal from sludge, especially from a developing country's perspective. Prevention is then the best strategy, because when the sludge is already contaminated, even if processed by incineration, environmental hazards may result.

48.2 METALS

48.2.1 Sources of metals in the sludge

Introductory concepts of metals in the wastewater are presented in Section 2.2.6 (*Characteristics of industrial wastewater*).

Although metals may eventually be poisonous to plants and animals, even in the low concentrations in which they normally occur in domestic wastewaters, chronic toxicity due to their disposal is usually not reported. On the other hand, the same is not true regarding the disposal of industrial wastewaters, and mainly their sludge, because they are the major sources of concentrated metals.

Metals in wastewater are mainly due to industrial wastewater discharges from the following industries into public sewerage systems:

- electroplating
- chemical industries (organic compounds manufacturing, tanning, pharmaceutical industries)
- metal processing industries (foundries)
- chemical industries (inorganic compounds manufacturing, laundries, oil industry, dyes and pigments manufacturing)

The source of important metals found in sludges from sewerage systems that receive industrial effluents are presented in Table 48.1.

48.2.2 Potential removal of metals in biological wastewater treatment processes

The characteristics of the liquid medium define the forms in which each constituent will be present. For instance, the more alkaline is the medium, the more insoluble

Table 48.1. Main sources of metals found in sludges

Metal	Main industrial sources of contamination
Cadmium	Non-metallic mineral products: glass, cement and concrete products; metallurgical products: iron, steel, electroplating; casting works; mechanical products: electrical and electronic components; lumber industry: furniture; rubber; chemical industry: phthalic anhydride, acetylation of cellulose, benzene carboxylation, phenol/formaldehyde and aniline/formaldehyde condensation and polymerisation, inorganic compounds and elements, dyestuffs and pigments, paints and varnishes, soaps and detergents; pharmaceutical products; textile industry; photographic equipment and plastics.
Copper	Non-metallic mineral products: glass, cement and concrete products; metallurgical products: electroplating, non-ferrous metals and castings; mechanical products; electrical and electronic components; lumber industry; furniture; leather, furs and similar products; chemical industry: (a) direct chlorination of benzene, toluene, 1,4-dichlorobenzene, nitrobenzene, phthalic anhydride, methane, ethylene, propylene, etc.; (b) cellulose/acetic anhydride acetylation; (c) cracking of liquid petroleum gas, naphta/oil gas, naphta/liquid petroleum gas; (d) extraction/distillation of pyrolysis-gasoline; inorganic compounds and elements; adhesives; oil industry; plastics, plastic material products; paints and varnishes; soaps and detergents; cosmetics and fragrances; textiles; hospitals; laundries; hot water piping.
Zinc	Non-metallic mineral products: glass, cement and concrete products; metallurgical products: iron, steel, electroplating, non-ferrous metals and castings; mechanical products; electrical and electronic components; furniture; rubber; leather, furs and similar products; several chemical industries; adhesives; explosives; oil industry; oils and waxes; pesticides; plastics; plastic material products; paints and varnishes; soaps and detergents; pharmaceutical products; cosmetics and fragrances; textiles; hospitals; laundries; photographic equipment.
Nickel	Non-metallic mineral products: glass, cement and concrete products; metallurgical products: iron, steel, electroplating, non-ferrous metals; mechanical products; electrical and electronic components; furniture; leather, furs and similar products; several chemical industries; dyestuffs and pigments; explosives; plastics; plastic material products; paints and varnishes; soaps and detergents; pharmaceutical products; cosmetics and fragrances; textiles; laundries; photographic equipment.
Mercury	Metallurgical products: electroplating, non-ferrous metals; electrical and electronic components; pharmaceutical products, fungicides; electric and electronic devices; furniture; paper and cardboard; several chemical industries; adhesives; explosives; fertilisers; pesticides; plastics; plastic material products; paints and varnishes; pharmaceutical products; textile; hospitals; laboratories; photographic equipment.
Chromium	Non-metallic mineral products: glass, cement and concrete products; metallurgical products: iron and steel, electroplating, non-ferrous metals and castings; mechanical products; electrical and electronic components; lumber industry; furniture; leather, furs and similar products; several chemical industries; adhesives; dyestuffs and pigments; fertilisers; oil industry; oils and waxes; plastics; plastic material products; paints and varnish; soaps and detergents; pharmaceutical products; cosmetics and fragrances; textile; photographic equipment.

(Continued)

Table 48.1 (*Continued*)

Metal	Main industrial sources of contamination
Lead	Non-metallic mineral products: glass, cement and concrete products; metallurgical products: iron and steel, electroplating, non-ferrous metals; mechanical products; electrical and electronic components; furniture; rubber; leather, furs and similar products; several chemical industries; adhesives, dyestuffs and pigments; explosives; oil industry; oils and waxes; plastics; plastic material products; paints and varnish; soaps and detergents; pharmaceutical products; cosmetics and fragrances; textile; hospitals; laundries; photographic equipment; storm drainage piping and building plumbing.
Arsenic	Metallurgical products: non-ferrous metals; electrical and electronic components; lumber industry; furniture; several chemical industries; oil industry; oils and waxes; pesticides; plastics; paints and varnishes; pharmaceutical products; textile; hospitals; laboratories; laundries.
Selenium	Non-metallic mineral products: glass, cement and concrete products; metallurgical products: iron and steel, non-ferrous metals; electrical and electronic components; furniture; rubber; several chemical industries; dyestuffs and pigments; paints and varnishes; textile; photographic equipment.

Source: ADEME (1998), Morita (1993), Fernandes and Silva (1999)

lead compounds will be formed, decreasing the lead concentration in the liquid effluent. Thus, the more alkaline the medium the higher will be the lead concentration in the sludge. Metallic compounds behave similarly to lead. Hence, depending on how the treatment plant is operated, metals can be routed to the solid or liquid phase.

Furthermore, the presence of other metals and cyanide may have a synergistic or antagonistic effect. An example is the increased toxicity of copper when cyanides are present. On the other hand, in the presence of chelating agents, such as EDTA-4 and HEDTA-3, the toxicity of bivalent metals may be reduced through a complexation process. If sulphates are present, metallic sulphates can precipitate and toxicity is reduced.

Ranges of metals removal efficiencies in several wastewater treatment systems are presented in Table 48.2. The wide ranges, reflecting large variabilities and site specificity, should be noted.

The concentration of metals in the sludge is highly variable from place to place, considering all the different influencing factors. Table 48.3 shows data from some wastewater treatment plants in Brazil. As said previously, the quality of the treatment plant effluent depends upon the quality of the influent. Therefore, liquid effluents and biosolids can only be conveniently disposed of if the influent to the plant is properly characterised and checked against pre-established pollutant limits. These limits depend upon both the final disposal methods and the treatment processes, since in many cases there are concentration limitations inherent to the process.

Table 48.2. Metals removal efficiencies through several biological wastewater treatment systems

Pollutant	Treatment process	% removal	Influent concentration (µg/L)	Effluent concentration (µg/L)	References
Arsenic	Activated sludge	20–98	–	b.d.t.–160	E.P.A (1980)
	Aerated lagoon	99	–	Nd–20	E.P.A (1980)
Cadmium	Primary	7	–	–	Helou (2000)
	Trickling filter	28	25 ⁺ ₇ –23	18 ⁺ ₇ –14	Hannah <i>et al.</i> (1986)
	Activated sludge	24	25 ⁺ ₇ –23	19 ⁺ ₇ –17	Hannah <i>et al.</i> (1986)
	Aerated lagoon	–	25 ⁺ ₇ –23	–	Hannah <i>et al.</i> (1986)
	Facultative pond	32	25 ⁺ ₇ –23	17 ⁺ ₇ –9	Hannah <i>et al.</i> (1986)
	Activated sludge	0–99	–	b.d.t.–13	E.P.A (1980)
	Aerated lagoon	97	–	2	E.P.A (1980)
Lead	Primary	20	–	–	Helou (2000)
	Trickling filter (M)	48	165 ⁺ ₇ –168	86 ⁺ ₇ –79	Hannah <i>et al.</i> (1986)
	Activated sludge (M)	6.5	165 ⁺ ₇ –168	58 ⁺ ₇ –75	Hannah <i>et al.</i> (1986)
	Aerated lagoon (M)	58	165 ⁺ ₇ –168	70 ⁺ ₇ –76	Hannah <i>et al.</i> (1986)
	Facultative pond (M)	50	165 ⁺ ₇ –168	82 ⁺ ₇ –76	Hannah <i>et al.</i> (1986)
	Activated sludge	10–99	–	Nd–120	E.P.A (1980)
	Aerated lagoon	80–99	–	Nd–80	E.P.A (1980)
Copper	Primary	18	–	–	Helou (2000)
	Trickling filter (M)	60	345 ⁺ ₇ –119	137 ⁺ ₇ –77	Hannah <i>et al.</i> (1986)
	Activated sludge (M)	82	345 ⁺ ₇ –119	61 ⁺ ₇ –40	Hannah <i>et al.</i> (1986)
	Aerated lagoon (M)	74	345 ⁺ ₇ –119	89 ⁺ ₇ –61	Hannah <i>et al.</i> (1986)
	Facultative pond (M)	79	345 ⁺ ₇ –119	71 ⁺ ₇ –46	Hannah <i>et al.</i> (1986)
	Activated sludge	2–99	–	b.d.t.–170	E.P.A (1980)
	Aerated lagoon	26–94	–	7–110	E.P.A (1980)
Chromium	Primary	16	–	–	Helou (2000)
	Trickling filter (M)	52	221 ⁺ ₇ –88	107 ⁺ ₇ –130	Hannah <i>et al.</i> (1986)
	Activated sludge (M)	82	221 ⁺ ₇ –88	40 ⁺ ₇ –18	Hannah <i>et al.</i> (1986)
	Aerated lagoon (M)	71	221 ⁺ ₇ –88	65 ⁺ ₇ –106	Hannah <i>et al.</i> (1986)
	Facultative pond (M)	79	221 ⁺ ₇ –88	46 ⁺ ₇ –34	Hannah <i>et al.</i> (1986)
	Activated sludge	5–98	–	b.d.t.–2000	E.P.A (1980)
Mercury	Primary	22	–	–	Helou (2000)
	Activated sludge	33–94	–	Nd–0.9	E.P.A (1980)
	Aerated lagoon	99	–	0.1–1.6	E.P.A (1980)
Nickel	Primary	6	–	–	Helou (2000)
	Trickling filter (M)	30	141 ⁺ ₇ –93	98 ⁺ ₇ –68	Hannah <i>et al.</i> (1986)
	Activated sludge (M)	43	141 ⁺ ₇ –93	61 ⁺ ₇ –45	Hannah <i>et al.</i> (1986)
	Aerated lagoon (M)	35	141 ⁺ ₇ –93	91 ⁺ ₇ –50	Hannah <i>et al.</i> (1986)
	Facultative pond (M)	43	141 ⁺ ₇ –93	81 ⁺ ₇ –59	Hannah <i>et al.</i> (1986)
	Activated sludge	0–99	–	Nd–400	E.P.A (1980)
	Aerated lagoon	0–50	–	5–40	E.P.A (1980)
Selenium	Aerated lagoon	50–99	–	Nd–200	E.P.A (1980)
Zinc	Primary	26	–	–	Helou (2000)
	Activated sludge	0–92	–	b.d.t.–38000	E.P.A (1980)
	Aerated lagoon	34–99	–	49–510	E.P.A (1980)

b.d.t. – below detection threshold Nd – not detected M – municipal wastewater
Source: Morita (1993). Details of references: See Morita (1993).

Table 48.3. Metal contents in the sludges from some Brazilian wastewater treatment plants and restrictions to further use

Chemicals	Concentration in mg/kg, dry basis							Maximum allowed concentration	
	Franca (CAS)	Barueri (CAS)	Suzano (CAS)	Northern Brasília (CAS)	Belem PR (EAAS)	Londrina (UASB)	USEPA		
							Paraná	Paraná	
Arsenic	<0.006	5-68	33-202		-	-	75	-	
Cadmium	0.06	8-20	2-7	<20	Nd	0.01	85	20	
Lead	3	101-152	187-273	50	123	101	840	750	
Copper	6	485-664	803-841	186	439	282	4,300	1,000	
Mercury	4	0-1.6	15	4	1	-	57	16	
Molybdenum	0.02	5-12	11	-	-	-	75	-	
Nickel	0.38	211-411	269-390	2.5-5.2	73	29	420	300	
Selenium	<0.06	Nd-1.4	Nd	-	-	-	100	-	
Zinc	4.4	1,800-2,127	1,793-2,846	280-1,500	824	1,041	7,500	2,500	

CAS: conventional activated sludge EAAS: extended aeration activated sludge UASB: upflow anaerobic sludge blanket reactor
 USEPA: 40 CFR Part 503 Paraná: State of Paraná, South Brazil Nd: not detected
 Source: adapted from Sapia (2000), Fernandes and Silva (1999), Helou (2000)

The limits in Table 48.3 refer mainly to the prevention of microorganisms' growth inhibition or toxicity. Therefore, one must set, for a certain constituent, the admissible load, taking into account process inhibition, effluent quality and biosolids beneficial use.

The discharge of a certain wastewater into the public sewerage system may have a variable impact on the wastewater treatment plant, depending upon dilution factors, content and type of pollutants, and the particular wastewater treatment system under operation. Proper assessment of the impact on the treatment processes may be approximated using laboratory or mathematical simulations. As a result, decisions can be taken regarding the acceptance or non-acceptance of industrial effluents to the treatment plant, taking into account inhibition of the biological treatment processes and compliance of the effluent and biosolids to pertinent legislation. The undesirable constituents are better controlled in the sources (industries and non-domestic activities).

The main purpose of the following example is to emphasise that the metals content in the wastewater has a large impact in the sludge produced. As no dilution or specific parameters from the plant were considered, the figures from the example may not be generalised.

Example 48.1

A conventional activated sludge treatment plant has an influent wastewater with 0.2 mg/L of Cd and 0.01 mg/L of Hg. Estimate the metals concentrations in the sludge, using the flow and sludge production data from Example 47.4.

Data:

- Treatment system: conventional activated sludge
- Flow: 9,820 m³/d
- Dewatered sludge production (dry basis): 1,739 kgSS/d
- Metals concentrations: Cd = 0.2 mg/L and Hg = 0.01 mg/L

Solution:

According to Table 48.2, the following removal efficiencies may be adopted: 24% Cd and 60% Hg.

As metals removed from the liquid phase through biological, chemical and physical mechanisms are concentrated in the sludge, a simple mass balance may be computed in order to estimate the resulting concentrations. Hence:

(a) Load of metals in the influent wastewater

$$\text{Cd} = 9,820,000 \text{ L/day} \times 0.2 \text{ mg/L} = 1,964,000 \text{ mg/d} = 1.964 \text{ kg/d}$$

$$\text{Hg} = 9,820,000 \text{ L/day} \times 0.01 \text{ mg/L} = 98,200 \text{ mg/d} = 0.098 \text{ kg/d}$$

(b) Load of metals retained in the sludge

$$\text{Cd} = 1,964,000 \text{ mg/day} \times 0.24 = 471,360 \text{ mg/d} = 0.471 \text{ kg/d}$$

$$\text{Hg} = 98,200 \text{ mg/day} \times 0.60 = 58,920 \text{ mg/d} = 0.059 \text{ kg/d}$$

Example 48.1 (Continued)

(c) Concentration of metals in the dewatered sludge (dry basis)

Since the sludge production on a dry basis is 1,739 kg/d, the resulting concentrations are:

$$\mathbf{Cd} = (471,360 \text{ mg/d}) / (1,739 \text{ kg/d}) = \mathbf{271 \text{ mg/kg}}$$

$$\mathbf{Hg} = (58,920 \text{ mg/d}) / (1,739 \text{ kg/d}) = \mathbf{34 \text{ mg/kg}}$$

(d) Concentration of metals in the treatment plant effluent

$$\text{Cd} = 0.20 \text{ mg/L} \times (1 - 0.24) = 0.15 \text{ mg/L}$$

$$\text{Hg} = 0.010 \text{ mg/L} \times (1 - 0.60) = 0.004 \text{ mg/L}$$

(e) Comments

The example adopts a simplified approach for didactic reasons, and cannot be generalised, because the estimation of the expected metal concentrations in the sludge can only be done based upon specific data of the wastewater treatment plant under consideration.

General comments on the results obtained are that, in this case, the Cd contents in the sludge (271 mg/kg) are higher than the limits of 85 and 20 mg/kg set by USEPA and the State of Paraná (Brazil), respectively (see Table 48.3). Regarding Hg, the resulting concentration of 34 mg/kg complies with the USEPA standard (57 mg/kg), but not with the State of Paraná standard (16 mg/kg). Therefore, the sludge may be considered unsuitable for agricultural reuse.

It may be noticed that some metals tend to concentrate more than others in sludge (Cd = 24% and Hg = 60%). However, in both cases, even with low concentrations in the influent wastewater (Cd = 0.2 and Hg = 0.01 mg/L), they are present in substantial concentrations in the sludge dry mass (Cd = 271 mg/kg and Hg = 34 mg/kg).

This fact highlights a significant operational problem, related to the detection limit and the accuracy of the laboratorial analytical methods. In many cases, the metals are not detected with precision in the liquid phase, due to the low allowable concentrations stipulated for discharge into the public sewerage system.

A preventive measure would be the requirement of an efficient treatment for the removal of metals from industrial effluents that are traditionally known to generate contaminated effluents, before discharging to the public sewerage system.

Many legislations state that the producers of the wastes are responsible for their treatment and final disposal. Furthermore, relying only on the “end of pipe” approach is against the modern environmental management principles,

Example 48.1 (Continued)

which recommend segregation of toxic components at the source, and not its dissemination.

These facts, together with the complexity of existing models to forecast the impact of polluting loads on the treatment systems, plus the difficulties in monitoring and effectively controlling the pollutant levels discharged into the sewers, are strong arguments towards the need to enforce adequate pre-treatment of toxic industrial effluents prior to their admittance to the public sewerage systems.

48.3 TRACE ORGANICS

Introductory concepts on organic contaminants in the wastewater are presented in Section 2.2.6 (*Characteristics of industrial wastewater*).

The main sources of organic compounds are: chemical industries, plastic industries, mechanical products, pharmaceutical industries, pesticide formulation, casthouses and steel industries, oil industry, laundries and lumber industries.

The most common organic pollutants in industrial effluents are: cyanide, phenol, methyl chloride, 1,1,1,-trichloroethane, toluene, ethyl benzene, trichloroethylene, tetrachloroethylene, chloroform, bis-2-ethyl-hexyl phthalate, 2,4-dimethyl phenol, naphthalene, butylbenzylphthalate, acrolein, xylene, cresol, acetophenone, methyl-sobutyl-acetone, diphenylamine, anilin and ethyl acetate.

Some guidelines concerning sludge organic contaminants are presented in Table 48.4.

A variety of organic compounds are receiving major attention as potential pollutants of soil, plants and water as a consequence of land application of the

Table 48.4. Guidelines for sludge organic contaminants (dry basis)

Constituent (mg/kg)	Denmark	Sweden	Germany
Toluene		5	
Linear alkylbenzenesulphonates	1,300		
Σ polycyclic aromatic hydrocarbons (PAH)	3	3 (sum of 6 specified PAHs)	
Nonylphenol (mono and diethoxylate)	10	50	
Di 2-ethylhexyl) phthalate	50		
Adsorbed organic halides			500
Polychlorinated biphenyl – PCB		0.4 (sum of 7 specified PCBs)	0.2 (for every 1 out of 6 specified PCBs)
Polychlorinated dibenzo-p-dioxin and polychlorinated dibenzofurans (ng/kg TEQ)			100

TEQ – toxicity equivalent in 2,3,7,8-tetrachlorodibenzo(p)dioxin

Source: da Silva *et al.* (2001)

sludge. In the beginning, chlorinated hydrocarbons, pesticides and polychlorinated biphenyls were the most studied compounds. Later researches have focused on compounds present in municipal wastewater treatment plants. Analyses made in 25 cities in the United States (Morita, 1993) indicated that several ester phthalates (diethyl, dibutyl) were present in 13% to 25% of the sludges in concentrations above 50 mg/kg. Toluene, phenol and naphthalene were also found in 11% to 25% of the sludges in levels higher than 50 mg/kg. Chlorinated methane, ethane and benzene were found in 3% to 36% of the sludges in concentrations above 1 mg/kg, although they were detected in relatively few sludges with values above 50 mg/kg. Trace organics were also investigated in 238 sludges in Michigan (Morita, 1993). The compounds detected in those sludges included acrylonitrile, chlorinated hydrocarbons, chlorinated benzenes, chlorinated phenols, styrene and hydroquinone. Compounds found in more than 25% of the sludges included 1,2 and 1,3-dichloropropane, 1,3-dichloropropene, tetrachlorethylene, 2,4-dinitrophenol, hydroquinone, phenol, pentachlorophenol and 2,4,6-trichlorophenol. In these compounds, the average concentrations were lower than 5 mg/kg, except for tetrachloroethylene (29 mg/kg). Styrene was found in 6 out of the 219 sludges, with concentrations varying from 99 to 5,858 mg/kg. Chlorobenzene and chlorotoluene were present in 6 sludges, varying from 60 to 846 mg/kg. These data suggest that most of the trace organics may be present in the majority of the sludges with concentrations lower than 10 mg/kg. However, an industrial contribution of a specific organic compound may dramatically increase its concentration in the sludge.

48.4 PATHOGENIC ORGANISMS

48.4.1 Preliminary considerations

Introductory concepts of pathogens in wastewater and indicator organisms are presented in Section 2.2.3.6 (*Pathogenic organisms and indicators of faecal contamination*).

Organisms found in sludge may be saprophytes, commensals, symbionts or parasites. Only parasites are pathogenic and able to cause diseases in human beings and animals. Five groups of pathogenic organisms may be found in sludge: (a) helminths, (b) protozoa, (c) fungi, (d) viruses and (e) bacteria.

The pathogenic organisms may come from human sources, reflecting directly the health status of the population and the sanitation level in the region. They may also come from animal sources, whose droppings are eliminated through the water-borne sewerage system (e.g., dog and cat faeces), or else through vectors in sewers, mainly rodents.

Regarding the pathogens in sludge, epidemiological surveys showed that bacteria, viruses, helminth eggs and protozoan cysts pose risks to human and animal health. These risks are due to:

- high incidence of parasitism found in the population in different parts of the world

- long survival time of helminth eggs in the environment (*Ascaris* sp. eggs can survive up to seven years)
- low infecting dose (one egg or cyst may be enough to infect the host)

The amount of pathogens in the wastewater from a specific municipality varies greatly and depends on:

- socio-economic level of the population
- sanitation conditions
- geographic region
- presence of agro-industries
- type of sludge treatment

The population of pathogens in the sludge also varies according to the conditions listed above. However, their concentration is also influenced by the sludge treatment processes (see Chapters 47 and 51). Wastewater treatment concentrates most of the load of organisms initially present in the influent in the sludge. In the separation stages, the organisms attach to the settling solid particles. Therefore, the same initial population may be found, although in higher concentrations. Another factor to be considered is the percentage of pathogens that are present, but non-viable, because the treatment processes are able to denaturalise them, that is, these organisms lose their infectivity.

48.4.2 Helminth eggs and protozoan cysts in the sludge

Table 48.5 shows important parasites (eggs, larvae or cysts) that can be found in the sludge. Helminth eggs and protozoan cysts are shown together, because their main removal mechanism in wastewater treatment is the same (sedimentation).

Table 48.5. Important parasites whose eggs (helminths) or cysts (protozoa) can be found in the sludge

Group	Parasite	Host
Nematodes	<i>Ascaris lumbricoides</i>	Man
	<i>Ascaris suum</i>	Swine
	<i>Ancylostoma duodenale</i>	Man
	<i>Necator americanus</i>	Man
	<i>Trichuris trichiura</i>	Man
	<i>Toxocara canis</i>	Dogs, man
	<i>Trichostrongylus axei</i>	Bovines, equines, man
Cestodes	<i>Taenia solium</i>	Man, swine
	<i>Taenia saginata</i>	Man, bovines
	<i>Hymenolepis nana</i>	Man, arthropods
	<i>Hymenolepis diminuta</i>	Rodents, arthropods
	<i>Echinococcus granulosus</i>	Dogs, sheep, man
Protozoa	<i>Entamoeba histolytica</i>	Man
	<i>Giardia lamblia</i>	Man, dogs, cats
	<i>Toxoplasma gondii</i>	Cats, man, mammals, birds
	<i>Balantidium coli</i>	Man, swine
	<i>Cryptosporidium</i>	Man, bovines

Source: Thomaz Soccol (2000)

Human beings and animals become infected through different ways. The oral route is epidemiologically the most important one, although other paths such as inhalation cannot be disregarded. Infection happens (a) directly, when ingesting or handling soil or vegetables containing viable helminth eggs or (b) indirectly, when drinking contaminated water or eating raw vegetables cultivated with biosolids containing helminth eggs or protozoan cysts.

The infective dose of helminths and protozoa is very low, and in some cases a single egg or cyst may be enough to infect the host (Table 48.6).

Table 48.6. Minimum Infective Dose (MID) for protozoan cysts and helminth eggs

Pathogenic organism	MID
Protozoan cysts	$10^0 - 10^2$
Helminth eggs	$10^0 - 10^1$

Source: WHO (1989)

48.4.3 Pathogenic bacteria in the sludge

Bacteria present in the sludge come from different sources, such as human and animal intestinal flora, soil, air and water. Although the incidence of entero-bacterial diseases transmitted by sewage sludge is low, the increase in the land applications of sludge may raise the risk. Table 48.7 lists pathogenic bacteria groups, which are of concern to human and animal health.

The transmission path of most enteric bacteria is faecal-oral via water and food. The inhalation of particles containing pathogens is also possible. This form of infection represents a higher risk for individuals directly working with sludge,

Table 48.7. Important pathogenic bacteria present in the sludge (primary settled sludge)

Organism	Disease	Reservoir (in animals)
<i>Salmonella paratyphi A, B, C</i>	Paratyphoid fever	Domestic and wild mammals, birds and turtles
<i>Salmonella typhi</i>	Typhoid fever	Mammals, domestic and wild birds
<i>Salmonella spp</i>	Salmonellosis	Bovines and other animals
<i>Shigella sonnei, S. flexneri, S. boydii, S. dysenteriae</i>	Dysentery	
<i>Vibrio cholerae</i>	Cholera	
<i>Yersinia enterocolitica</i>	Gastroenteritis	Mammals, domestic and wild birds
<i>Campylobacter jejuni</i>	Gastroenteritis	Domestic animals, dogs, cats and birds
<i>Escherichia coli</i>	Gastroenteritis	Domestic animals
<i>Leptospira spp</i>	Leptospirosis	Domestic and wild mammals, rats

Source: EPA (1992), ADEME (1998)

such as treatment plant employees, transportation workers and biosolid spreaders. Farmers working in biosolids fertilised soils also represent a hazard population. Some bacteria persist in infected animals that act as reservoirs. Several factors increase the possibility of pathogen transmission through biosolids application in gardens and leaf-bearing plant crops, namely:

- persistence of pathogens in the biosolids, even after treatment;
- food-borne transmission;
- pathogens reservoir in human and animal population;
- immunologically deprived people and susceptibility of pregnant women.

Anaerobically digested sludge containing bacteria applied in agricultural land may not pose considerable risks to farmers, since the survival of these pathogens in pastures is shorter than in the soil, decreasing rapidly in the upper parts of the grass, compared to the region in the vicinity of the soil.

Although the minimum infective dose for bacteria may vary from one pathogenic organism to another, it usually ranges from 10^2 to 10^6 (EPA, 1992). *Salmonella* sp. and *Shigella* sp., as the commonest pathogenic bacteria found in domestic sewage, probably are the major infecting hazard. Oral infective doses for *Salmonella* are reported to be lower than 10^3 bacteria. It is important to emphasise that bacteria are potential sources of epidemic diseases and, as a result, they must be monitored in the various wastewater treatment plants.

48.4.4 Pathogenic viruses in the sludge

Viruses are present in different types of wastewaters and sludges proceeding from various treatment processes. Their concentration is variable and depends on the population health conditions, the type of wastewater treatment process used and the stabilisation process applied for the sludge.

Viruses affect both human beings and animals, and they may be transmitted through soil, food, water, aerosols or dust. The transmission may also take place through mucosa contact and inhalation. These indirect ways of contamination represent risks for treatment plant workers, biosolid spreaders and people handling dry or liquid sludge-derived products. People living by river banks whose soil has been fertilised with biosolids are also exposed to risks. Important viruses found in domestic sludge are listed in Table 48.8.

Virus infection usually occurs via a direct path through the mouth, aspiration or ingestion of sludge. Indirect infection may happen through ingestion of pathogen-contaminated water or food. The minimum infective dose is in the order of 10^2 viruses. It must be considered that both men and animals may be infected from other sources, and these may be much more important than the biosolids.

48.4.5 Density of pathogenic organisms in sludge

The amount of pathogens found in sludge is not steady and may vary, for instance, with time (month, year, season), sampling process and other factors. Literature

Table 48.8. Important viruses found in the sludge that may affect human health

Enteric viruses	Disease	Host
Hepatitis virus	Infectious hepatitis	man
Rotavirus	Gastroenteritis	man
Enterovirus	Meningitis, encephalitis, respiratory diseases	man
Poliovirus	Poliomyelitis	man
Coxsackievirus	Meningitis, pneumonia	man
Echovirus	Meningitis, paralysis	man
Astrovirus	Gastroenteritis	man
Calicivirus	Gastroenteritis	man
Reovirus	Gastroenteritis, respiratory infections	man

Source: ADEME (1998)

data show that in primary sludge the number of helminth eggs present may be in the range of $10^3 - 10^4$ per kg TS (total solids or dry solids) or more, while viruses may range from 10 to 10^6 per kgTS.

In Brazil, Ayres *et al.* (1994) found helminth eggs densities in the order of 40 eggs/gTS in the sludge from stabilisation ponds. Other data from stabilisation ponds are presented in Chapter 22. Thomaz Soccol *et al.* (1997), working with aerobically digested sludge (extended aeration plant in South Brazil) noticed a variable number of helminth eggs along the year, ranging from 1 to 3 eggs per g/TS, with a reduction in viability from 40% to 83%. Another plant in South Brazil had an average density of 76 eggs/gTS. Passamani *et al.* (2000) found 12 helminth eggs/gTS in a plant in Southeast Brazil. In Sao Paulo, data published by Tsutya (2000) indicate average figures between 0.25 and 0.31 eggs/gTS in a conventional activated sludge plant. In Brasília, Ludovice (2000) reported, for activated sludge plants, 16 helminth eggs per 100 mL of sludge with TS concentrations of 5%.

Table 48.9 shows density ranges for different types of pathogens and sludges.

48.4.6 Public health implications of pathogens in the sludge

Multi-purpose handling and application of domestic sewage sludge without previous stabilisation and sanitisation treatment may cause infection in human beings and animals by pathogenic agents. Infection may occur through mouth or aspiration and may happen through direct or indirect contact.

Direct way:

- during sludge spreading in soil, individuals may directly inhale or ingest pathogen-containing particles;
- through handling or ingestion of raw vegetables grown in soil fertilised with untreated sludge;

Table 48.9. Concentration of pathogenic organisms in primary and digested sludge

Pathogen	Type of sludge	Density of pathogens
Helminth eggs	Primary sludge	$10^3 - 10^4/\text{kg TS}$
	Digested sludge	$10^2 - 10^3/\text{kg TS}$
	Partially-dewatered sludge	$10^1 - 10^3/\text{kg TS}$
	Partially-dewatered sludge from aerobic treatment	$10^2 - 7.5 \cdot 10^4/\text{kg TS}$
	Anaerobic sludge	$6.3 \cdot 10^3 - 1.5 \cdot 10^4/\text{kg TS}$
Protozoan cysts	Primary sludge	$7.7 \cdot 10^4 - 3 \cdot 10^6/\text{kg TS}$
	Digested sludge	$3 \cdot 10^4 - 4.1 \cdot 10^6/\text{kg TS}$
	Dewatered sludge	$7 \cdot 10^1 - 10^2/\text{kg TS}$
Bacteria	Sludge	$10^1 - 8.8 \cdot 10^6/\text{kg TS}$
	Extended aeration sludge	$10^8/\text{kg TS}$
Viruses	Primary sludge	$3.8 \cdot 10^3 - 1.2 \cdot 10^5/\text{L}$
	Digested sludge	$10^1 - 10^3/\text{L}$
	Biological sludge	$10^1 - 8.8 \cdot 10^6/\text{kg TS}$

Source: Feix and Wiart (1998), Thomaz Soccol *et al.* (1997, 2000)

- animals are also susceptible of being directly contaminated and thus have clinical problems or serve as living reservoirs for certain pathogenic organisms.

Indirect way:

- drinking water contaminated with sludge containing pathogenic organisms;
- ingestion of meat from animals previously contaminated with helminth eggs (*Tenia* eggs), giving continuity to the biological cycle of the parasite.

48.4.7 Survival of pathogenic organisms

(a) Survival of pathogens in soil

Organisms such as bacteria, viruses, helminths (eggs, larvae and adults), protozoa (cysts) can be usually found in soil coming from livestock, wild animals, contaminated rivers, soil parasites, plants, or man himself. There are also free-living organisms, which do not pose hazards to livestock or men, although they may lead to erroneous diagnosis related to pathogenic agents in the sludge incorporated into soil.

When untreated sludge is applied to the soil, the pathogenic organisms remain on the surface of the soil and plants. Their survival time varies according to:

- *Survival capability of the organism itself.*
- *Soil texture and pH.* In sandy soils, the survival time of helminth eggs is lower than in wet soils. Hence, the survival time varies from place to place, and generalisations are difficult.
- *Incidence of sunlight.* Direct sunshine on the organisms leads to desiccation and reduces their survival time.

- *Ambient temperature.* Lifetime of protozoa cysts and helminth eggs in summer is shorter than in winter. In regions where autumn is cold and spring rainy, the pathogenic organisms survive for a longer period.
- *Sludge application method.* When the sludge is directly applied onto the soil, sunshine reduces the survival time of parasites. When the sludge is incorporated into the soil, it has less exposure and pathogenic life span increases. Incorporated sludge has lower direct contact risks for men and animals. How deep pathogenic organisms may reach into the ground depends upon the soil texture, geological faults and erosion areas near the application site.
- *Water retaining capability.* Low moisture sandy soils favour longer survival times for some organisms (Ancylostomatidae), while reducing for others (bacteria).
- *Microorganisms in the soil.* Competition among microorganisms may or may not favour the survival of pathogens, altering the ecological equilibrium.

Medeiros *et al.* (1999) studied the life span of sewage sludge pathogenic organisms in agricultural land, and found *Salmonella* sp. absence 42 days after sludge application. *Enterococcus* and faecal coliforms were reduced by 2 log units after 134 days. Survival of helminth eggs reached 20% after 180 days (Thomaz Soccol *et al.*, 1997).

Table 48.10 presents a general synthesis of survival time for viruses, bacteria and parasites in the soil.

(b) Survival of pathogens on crops

Pathogens survival on crops varies with the type of organism and the plant characteristics. Again, viruses, bacteria and protozoa have shorter survival time than

Table 48.10. Survival time of pathogenic organisms in the soil

Pathogenic organism	Type of soil	Mean survival time	Maximum survival time
Viruses			
Enteroviruses	Different types	12 days	100 days
Bacteria			
Faecal coliforms	Top soil	40 days	90 days
<i>Salmonella</i> sp.	Sandy soil	30 days	60 days
	Soil (deep layer)	70 days	90 days
<i>Vibrio cholerae</i>		5 days	30 days
Protozoa			
Amoebae		10–15 days	30 days
Nematodes			
	Irrigated soil	Several months	2–3 years
<i>Ascaris</i> sp.	Soil	Several months	7–14 years
<i>Toxocara</i> sp.	Soil	Several months	8 months
<i>Taenia</i> sp.	Soil	15–30 days (dry summer)	3–15 months (winter)

Source: EPA (1992), Gaspard *et al.* (1995, 1996), ADEME (1998), Schwartzbrod *et al.* (1990), Medeiros *et al.* (1999), Thomaz Soccol *et al.* (1997)

Table 48.11. Survival time of pathogenic organisms in vegetables and roots

Organism	Type of food	Maximum survival time (days)
Viruses	Beans	4
	Crops	60
Bacteria (<i>Salmonella</i>)	Potato and vegetables	40
	Carrot	10
Protozoan cysts	Vegetables	3–15
Helminth eggs	Vegetables	27–35
	Lettuce	8–15
	Tomato	28
	Beet (leaves and root)	10–30

Source: Berron (1984), quoted by ADEME (1998)

helminth eggs, particularly eggs with thicker membranes like *Ascaris* sp. and *Taenia* sp. Survival times range from 4 to 60 days for viruses, 10 to 40 days for bacteria, not more than 15 days for protozoa and several months for helminth eggs, as shown in Table 48.11.

Of course, crops that have direct contact with the soil have higher risks of having pathogenic organisms, whereas aerial plants such as apple and orange trees have lower probability of contamination. Schwartzbrod *et al.* (1990) demonstrated that helminth eggs are able to survive from 8 to 15 days in lettuce, 28 days in tomatoes, and from 10 to 30 days in radishes.

Animals grazing in pastures after biosolids application may be contaminated with pathogens. Epidemics and adverse effects on reproduction capability may occur in pathogenic bacteria contamination cases. As for parasites, it is important to mention the case of *Taenia saginata*. If there are *Taenia saginata* eggs in the applied sludge, and these eggs are ingested by the livestock, a larva phase (*Cysticercus bovis*) will evolve and may complete its life-cycle as adult *Taenia* in man's small intestine, if the infected meat is ingested. The affected meat most likely will be refused during the carcass sanitary inspection, causing serious economic damages. Animals may indirectly become infected if fed with hay grown in a sludge-applied area.

Sludge stabilisation

M. Luduvic

49.1 INTRODUCTION

Sewage sludge in its natural state (raw sludge) is rich in pathogenic organisms, easily putrescible and rapidly developing unpleasant smells. Stabilisation processes were developed with the purpose of stabilising the biodegradable fraction of organic matter present in the sludge, thus reducing the risk of putrefaction as well as diminishing the concentration of pathogens. The stabilisation processes can be divided into (see Figure 49.1):

- **biological stabilisation:** specific bacteria promote the stabilisation of the biodegradable fraction of the organic matter
- **chemical stabilisation:** chemical oxidation of the organic matter accomplishes sludge stabilisation
- **thermal stabilisation:** heat stabilises the volatile fraction of sludge in hermetically sealed containers

The main focus of the present chapter will be on the most widely used approach of *biological stabilisation*.

The mesophilic **anaerobic digestion** is the main sludge stabilisation process used worldwide. Aerobic digestion of sewage sludge is less popular than anaerobic digestion, and encounters application for the stabilisation of biological excess sludge in biological nutrient removal activated sludge plants. Composting is common in municipal solid waste processing plants, and is also used by a limited

Table 49.1. Sludge stabilisation technologies and final disposal methods

Treatment process	Final disposal method or use
Aerobic/anaerobic digestion	Biosolid suitable for restricted use in agriculture as soil conditioner and organic fertiliser. Usually followed by dewatering, requires further treatment (disinfection) for unrestricted uses in agriculture
Chemical treatment (alkaline stabilisation)	Used in agriculture or as daily landfill covering
Composting	Topsoil like material suitable for nurseries, horticulture and landscaping. Uses dewatered sludge
Thermal drying (pelletisation)	Product with high solids content, substantial concentration of nitrogen and free from pathogens. Unrestricted use in agriculture

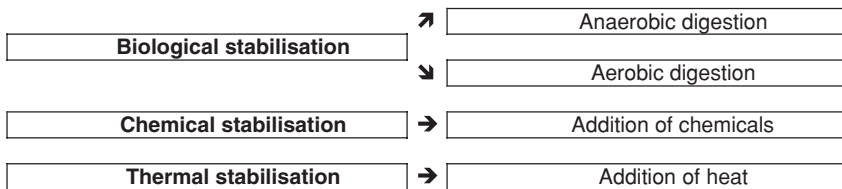

Figure 49.1. Main processes for sludge stabilisation

number of small wastewater treatment plants. Alkaline treatment and thermal drying are also processes for sludge stabilisation.

Table 49.1 shows stabilisation processes and associated sludge final disposal methods, including uses as soil conditioner or organic amendment for fields and crops.

In the various wastewater treatment systems discussed in this book and listed in Table 49.2, it is possible to notice that the degree of sludge stabilisation depends upon the wastewater treatment process adopted.

49.2 ANAEROBIC DIGESTION

49.2.1 Introduction

The word *digestion* in wastewater treatment is applied to the stabilisation of the organic matter through the action of bacteria in contact with the sludge, in conditions that are favourable for their growth and reproduction. Digestion processes may be anaerobic, aerobic or even a combination of both. Table 49.3 shows the main differences between raw sludge and digested sludge.

The anaerobic digestion process, characterised by the stabilisation of organic matter in an oxygen-free environment, has been known by sanitary engineers since the late 19th century. Due to its robustness and efficiency, it is applied to small systems such as simple septic tanks (acting as an individual solution for a

Table 49.2. Wastewater treatment processes and the corresponding degree of sludge stabilisation

System	Characteristics of the sludge		
	Primary sludge	Secondary sludge	Chemical sludge
Primary treatment (conventional)	raw		
Primary treatment (septic tanks)	stabilised		
Primary treatment with coagulation (chemically enhanced)	raw		
Facultative pond		stabilised	
Anaerobic pond + facultative pond		stabilised	
Facultative aerated lagoon		stabilised	
Complete-mix aerated lagoon + sedimentation pond		stabilised	
Facultative pond + maturation pond		stabilised	
Facultative pond + high-rate pond		stabilised	
Facultative pond + physical-chemical algae removal		non-stabilised	
Slow rate infiltration		(a)	
Rapid infiltration		(a)	
Overland flow		(a)	
Wetland		(a)	
Septic tank + anaerobic filter	stabilised	stabilised	
Septic tank + infiltration	stabilised	(a)	
UASB reactor		stabilised	
UASB + activated sludge		stabilised (b)	
UASB + submerged aerated biofilter		stabilised (b)	
UASB + anaerobic filter		stabilised	
UASB + high-rate trickling filter		stabilised (b)	
UASB + flotation		stabilised	stabilised
UASB + polishing ponds		stabilised	
UASB + overland flow		stabilised (a)	
Conventional activated sludge	raw	non-stabilised	
Extended aeration		stabilised	
Sequencing batch reactor (extended aeration)		stabilised	
Conventional activated sludge with biological N/P removal	raw	non-stabilised	
Activated sludge with chemical and biological N/P removal		non-stabilised	non-stabilised
Low-rate trickling filter	non-stabilised	non-stabilised	
High-rate trickling filter	non-stabilised	non-stabilised	
Submerged aerated biofilter		non-stabilised	
Rotating biological contactor	non-stabilised	non-stabilised	

(a): In land-disposal wastewater treatment systems, the periodic removal of formed plant biomass is necessary

(b): Assumes return of the aerobic excess sludge to the anaerobic reactor, for further thickening and digestion, together with the anaerobic sludge

Table 49.3. Comparison between raw sludge and anaerobically digested sludge

Raw sludge	Digested sludge
Unstable organic matter	Stabilised organic matter
High biodegradable fraction in organic matter	Low fraction of biodegradable organic matter
High potential for generation of odours	Low potential for generation of odours
High concentration of pathogens	Concentration of pathogens lower than in raw sludge

house) as well as in fully automated plants serving large metropolitan areas. The anaerobic digestion process underwent noticeable progresses between the First and the Second World Wars. Several concepts related to the process were improved at that time, especially in Germany, England and the United States, and are still being used today in the design of digesters.

Anaerobic digestion is a multi-stage biochemical process, capable of stabilising different types of organic matter. The process occurs in three stages (for further details, see Chapters 9 and 24):

- Enzymes break down complex organic compounds, such as cellulose, proteins and lipids, into soluble compounds, such as fatty acids, alcohol, carbon dioxide and ammonia.
- Microorganisms convert the first-stage products into acetic and propionic acid, hydrogen, carbon dioxide, besides other low-molecular weight organic acids.
- Two groups of methane-forming organisms take action: one group produces methane from carbon dioxide and hydrogen, while a second group converts the acetates into methane and bicarbonates.

49.2.2 Main requisites for sludge digestion

The efficiency and stability of the anaerobic digestion process are variables directly related to the characteristics of the raw sludge and the environment inside the digester. The raw sludge that enters the anaerobic digester is a complex mixture of materials whose characteristics are determined by the area served by the treatment plant and the wastewater treatment process adopted.

Normally, the presence of macro- and micronutrients is sufficient for ensuring the development of the anaerobic digestion process, except in the cases of digesters treating only industrial sludges. If nutrients are not a reason for concern, the presence of other materials can affect the operational performance of the sludge digester. Therefore, it is important to observe the following requisites:

Preliminary treatment. The raw sludge that comes from the primary sedimentation tanks contains, with rare exceptions, large concentrations of fibre, plastics, sand and other inert materials. These materials may pass through the preliminary treatment – screens and grit chambers – and settle with the primary sludge, causing obstruction and breakage of pipes, damage to pump rotors and to digesters mixing

devices. The accumulation of sand and other materials within the digester will end up by reducing the digester net volume and, as a consequence, its efficiency. The performance of the preliminary treatment is of great importance, both to keep digestion efficiency and to reduce maintenance interventions in the digester tank.

Solids concentration. Sludge thickening is used aiming at the reduction of the volume required for digestion. Thickening is accomplished in gravity thickeners, dissolved air flotation units, or even in primary sedimentation tanks. It is desirable to have solids concentrations in the raw sludge fed to digestion in the order of 4% to 8%. Higher solids concentrations can be used, as long as the feeding and mixing units are able to handle the solids increase. Solids concentrations lower than 2.5% are not recommended, as excess water has a negative effect on the digestion process.

Inhibiting substances. Anaerobic bacteria are sensitive to several substances that, depending upon their concentrations, are capable to completely stop the digestion process. A strict control on the discharge of industrial effluents into the sewerage system and an effective legislation are the main tools to avoid the presence of toxic substances in municipal wastewater. The main inhibiting agents are hydrocarbons, organochlorinated compounds, non-biodegradable anionic detergent, oxidising agents and inorganic cations. Further details can be found in Chapter 48.

Non-biodegradable synthetic detergents are of great concern. Although their utilisation for the production of detergents has been banned in many countries, they can still be found in several other areas.

Oxidising agents like cupric ion, ferric ion and hexavalent chromium may exert an inhibiting action during the methanogenic phase of digestion, after the removal of a substantial fraction of organic matter. These ions react with sulphide ions, changing the sulphur balance inside digesters.

Inorganic cations such as sodium, potassium, calcium and magnesium, although nutrients at very low concentrations, could strongly inhibit the process at high concentrations. Optimal ammonia concentrations range from 50–1,000 mg/L; between 1,000–1,500 mg/L moderate inhibition may happen; for 3,000 mg/L and higher, strong inhibition occurs. However, these concentrations are not usual, being often associated with hog raising influents into the system.

Metals. The word *metal* in this context encompasses metals like copper, zinc, mercury, cadmium, chromium, nickel and lead. These metals can inhibit the anaerobic digestion when present individually or as metallic compounds, after reacting with enzymes needed for the process and forming insoluble complex compounds. Excluding cadmium and mercury, the other metals are considered micronutrients if present in adequate concentrations.

The destruction of organic matter during anaerobic digestion causes the metal concentration in the digested sludge to become greater than in the raw sludge (on a dry solids basis). The metal toxicity varies depending upon the metal, the presence of other metals, the pH and the concentrations of sulphide and carbonate in the sludge.

49.2.3 Process description

In a conventional activated sludge WWTP, mixed primary sludge and excess activated sludge are biologically stabilised under anaerobic conditions and converted into methane (CH_4) and carbon dioxide (CO_2). The process is accomplished in closed biological reactors known as anaerobic sludge digesters. Digester tanks are fed with sludge either continuously or in batches, and the sludge is kept inside the tank for a certain period of time previously determined during the design phase. The sludge and the solids have the same detention time in the digester.

The organic fraction of the sludge is basically made up of polysaccharides, proteins and fat. Inside the sludge digesters, colonies of anaerobic microorganisms convert the organic matter into cellular mass, methane, carbon dioxide and other micro-constituents. Inside the digester tank, three groups of mutually dependent Microorganisms coexist:

- hydrolytic acidogenic organisms
- acetogenic organisms
- methanogenic organisms

This population of microorganisms remains in a dynamic equilibrium and their concentrations vary depending upon the operational conditions within the tank.

Sulphate-reducing and denitrifying bacteria are also microorganisms occurring in anaerobic digestion and playing a fundamental role in the stabilisation process. The sulphate-reducing bacteria are responsible for the reduction of sulphate (SO_4^{2-}) to sulphide ($\text{S}^{=}$), while denitrifying bacteria reduce nitrate (NO_3^-) to gaseous nitrogen (N_2).

The redox potential inside anaerobic sludge digesters is $-265 \text{ mV} \pm 25 \text{ mV}$ at pH 7, and can be reduced by 60 mV per every pH unit increase. A reducing environment prevails inside the digesters. Digestion may successfully occur in pH 6–8, although pH is kept nearly neutral in practice, due to buffering capacities of bicarbonates, sulphides and ammonia. The optimum pH for anaerobic process is 7.0. Unionised acetic acid inhibits digestion in acidic pH, while unionised ammonia (NH_3) is toxic to the process in alkaline pH.

The nutritional balance within the digester is vital to control bacterial growth, and consequently, the organic matter stabilisation rate. The main nutrients, in decreasing order of importance, are nitrogen, sulphur and phosphorus. Iron, cobalt, nickel, molybdenum and selenium are major micronutrients. Iron, due to its oxidation-reduction properties and its participation in energetic metabolism, is considered the most important micronutrient in anaerobic digestion.

Biochemical aspects and the main pathways of anaerobic digestion are covered in detail in Chapters 9 and 24.

49.2.4 Reaction kinetics

The performance of anaerobic sludge digesters is directly linked to the concentration and diversity of the population of microorganisms present in the sludge.

The solids retention time within the digester (θ_c) must be enough to ensure the maintenance of the microorganisms which have a slow growth rate, such as the methanogenic organisms, thus avoiding their wash-out from the system.

In conventional anaerobic digesters operating as complete-mix reactors, the solids retention time (sludge age) is equivalent to the hydraulic detention time, and can be determined by Equation 49.1.

$$\boxed{t = \theta_c = \frac{V}{Q}} \quad (49.1)$$

where:

t = hydraulic detention time (d)

θ_c = solids retention time (d)

V = volume of the sludge digester (m^3)

Q = influent flow to the sludge digester (m^3/d)

The slow growth rate of the methanogenic population determines the reaction time required for the anaerobic digestion process to be accomplished and, as a result, the required sludge retention time within the digester tank. Other characteristics related to θ_c and of great importance in the performance of anaerobic digesters are:

- for detention times shorter than a critical value, the process efficiency is suddenly reduced due to methanogenic organisms washout
- anaerobic digester efficiency does not increase indefinitely as detention time increases. After an optimum time is reached, the gains in efficiency are limited, not justifying further investments
- the conversion rate of the organic matter does not depend on the sludge volume fed daily to the digesters

In practice, anaerobic digesters are designed taking into consideration a detention time higher than optimum to compensate occasional operational problems such as (a) fluctuation of the sludge volume production rate, (b) inefficiency of the sludge mixing system, (c) variation of ambient temperature and (d) silting due to accumulation of inert material inside the tank.

As shown in Table 49.4, the kinetics of anaerobic digestion depends mainly on the methanogenic organisms. In normal situations, there is a perfect interaction

Table 49.4. Main characteristics of anaerobic organisms

Parameters	Acidogenic and acetogenic organisms	Methanogenic organisms
Growth rate	High	Slow
pH	Low sensitivity	High sensitivity
Temperature	Moderate sensitivity	High sensitivity
Toxic agents	Moderate sensitivity	High sensitivity
Volatile acids	Low sensitivity	High sensitivity
Redox potential	Low sensitivity	High sensitivity

between the medium and the different groups of organisms. When this balance is affected, the reaction process is also affected. For instance, the following effects of organic overloading in an anaerobic digester may be listed:

- acidogenic bacteria convert organic matter into volatile acids at a higher rate than methanogenic organisms are able to process
- volatile acids concentration is increased, reacting with alkalinity, and hence inhibiting the buffering capacity of the medium and lowering the pH value
- methanogenic organisms are inhibited due to reactor acidification
- acetogenic bacteria are inhibited due to the increasing acidification of the medium. Methane production ceases and the anaerobic digestion process starts to collapse

49.2.5 Reduction of pathogens

Raw sludge concentrates a great variety of pathogenic organisms. The concentration and type of those organisms reflect the standard of living in the treatment plant service area. The presence and concentration of certain organisms in the raw sludge may also indicate the contribution from slaughterhouses or animal related centres. This is particularly true in small wastewater treatment plants serving rural areas.

Sludge digestion significantly reduces the population of organisms, favouring the agricultural use of the sludge. Anaerobic stabilisation acts as a partial barrier between pathogenic agents and sludge users, reducing the risks of disease transmission. Chapter 51 deals with the disinfection during sludge treatment.

49.2.6 Design of anaerobic digesters

Anaerobic digesters are closed biological reactors made of concrete or steel. Inside these reactors the raw sludge is mixed – and heated, in temperate-climate countries – usually with the biogas produced, stored in floating gas holders for processing or burning. The configuration of the sludge digesters varies depending upon the area available, the need of keeping complete-mix conditions and the removal of sand and foam. Traditional anaerobic digester designs used 8–40 m diameter cylinders with 1:3 conical bottom slopes. Bottom slopes steeper than 1:3 favour sand removal but are seldom used, as they are hard to build. More recently, egg-shaped digesters have been preferred both by designers and operators, as foam and sand control are more easily accomplished thanks to its high-sloped sidewalls. Mixing requirements are not so demanding when compared with cylinder-shaped sludge digesters (Figure 49.2).

Heat loss through the walls of the anaerobic digester can be considerable, especially in cold climates. Refractory bricks on the outer wall have good aesthetics and minimise heat losses. Occasionally, half-buried sludge digesters are found, although this is not an advisable practice, since the soil, when wet, is a poor heat insulator.

Table 49.5. Typical design parameters for anaerobic sludge digesters

Parameters	Typical values
Detention time (θ_c) (d)	18–25
Volumetric organic load ($\text{kgVS}/\text{m}^3\cdot\text{d}$)	0.8–1.6
Total solids volumetric load ($\text{kgSS}/\text{m}^3\cdot\text{d}$)	1.0–2.0
Influent raw sludge solids concentration (%)	3–8
Volatile solids fraction in raw sludge (%)	70–80
Efficiency in total solids reduction (% TS)	30–35
Efficiency in volatile solids reduction (% VS)	40–55
Gas production (m^3/kgVS destroyed)	0.8–1.1
Calorific value of gas (MJ/m^3)	23.3
Digested sludge production ($\text{gTS}/\text{inhabitant}\cdot\text{day}$)	38–50
Gas production ($\text{L}/\text{inhabitant}\cdot\text{day}$)	20–30
Raw sludge heating power (MJ/kgTS)	15–25
Digested sludge heating power (MJ/kgTS)	8–15

Source: Adapted from CIWEM (1996)

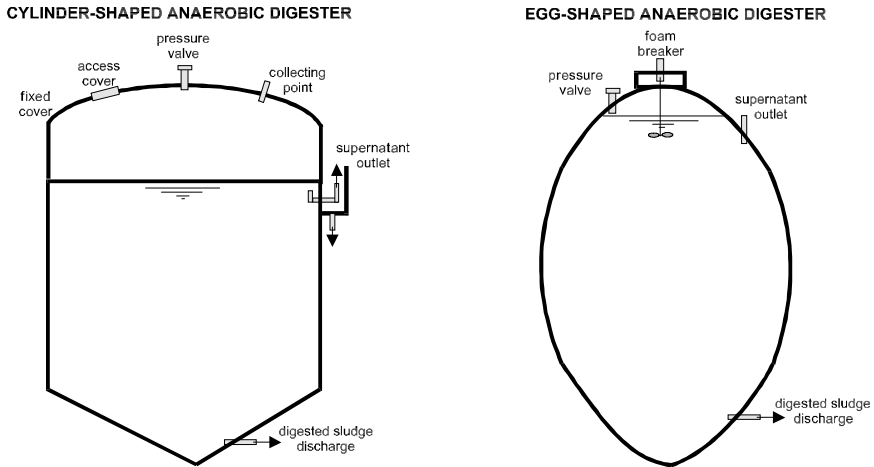

Figure 49.2. Typical formats of anaerobic digesters (adapted from WEF, 1996)

Most cylinder-shaped sludge digesters have less than 25 m diameter. Traditional design has a height-to-diameter ratio ranging from 1:2 to 1:3, and up to 33% bottom slopes. Nowadays, anaerobic digesters are also being designed with a 1:1 height:diameter ratio and a small or even zero floor slope.

Until the 1970s, the anaerobic digesters were designed for 25–30 day detention time to counterbalance possible volume losses due to sand accumulation, high water content of the raw sludge and deficiency of the mixing system. Nowadays, there is a trend to reduce the detention time to 18–25 days in warm-climate regions. Typical parameters for anaerobic sludge digesters design are listed in Table 49.5.

The required volume for the sludge digesters is given by:

$$V = \frac{\text{Influent VS load (kgVS/d)}}{\text{Volumetric organic loading (kgVS/m}^3\text{.d)}} \quad (49.2)$$

49.2.7 Mixing in anaerobic sludge digesters

As previously mentioned, the maintenance of a homogeneous sludge medium within the digester is a fundamental requirement for its good performance. Keeping homogeneity is assured through sludge mixing devices, aiming to:

- assure the internal medium uniformity from the physical, chemical and biological points of view
- quickly disperse the raw sludge when it enters the tank
- minimise thermal stratification, avoiding temperature gradients
- minimise foam formation and inert material (mainly sand) accumulation
- maximise the useful volume of the digester, minimising hydraulic short circuits and the occurrence of dead zones
- dilute the concentration of occasional inhibiting agents throughout the digester volume

The main types of sludge mixing used in anaerobic digesters are shown in Figure 49.3.

Mixing systems are either mechanical or compressed gas driven. Compressed gas systems use their own pressurised digestion gas. Gas pressurisation takes place outside the digester tank and the distribution is either through diffusers over the tank bottom or vertically along the digester sidewalls. The type of mixing system is determined by the shape and volume of the sludge digesters and the characteristics of the sludge to be digested.

Medium and large plants usually have two sludge digesters in series to optimise both the digestion process and the performance of the sludge dewatering. While

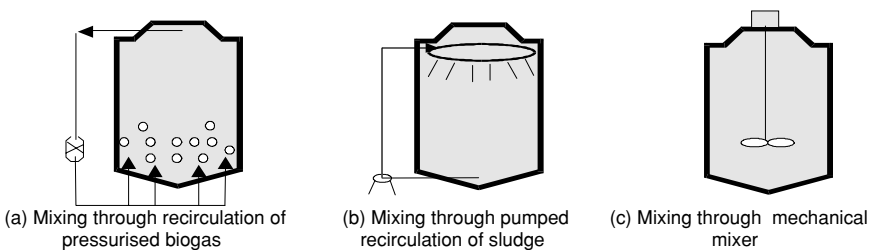

Figure 49.3. Main types of sludge mixing used in anaerobic digesters (adapted from Ferreira Neto, 1999)

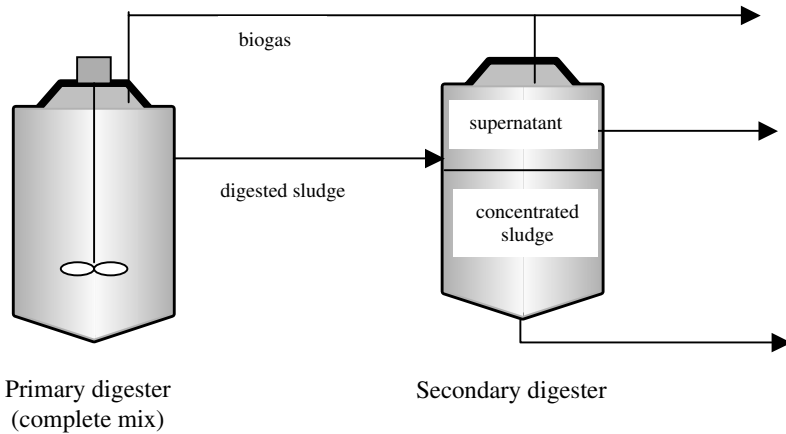

Figure 49.4. Two-stage anaerobic sludge digestion system

the *primary digester* is a complete-mix reactor responsible for fast stabilisation of the organic matter, in the *secondary digester* the separation of solid/liquid phases prevails. Secondary digesters usually do not have mixing or heating systems, except when designed to replace the primary digester during maintenance periods.

The design of secondary digesters follows the same principles presented in Table 49.5. Figure 49.4 illustrates a two-stage digestion system.

49.2.8 Biogas

Anaerobic digestion processes produce biogas, which is basically a mixture of methane (CH_4), carbon dioxide (CO_2), small concentrations of nitrogen, oxygen, hydrogen sulphide (H_2S) and traces of volatile hydrocarbons.

Biogas production in anaerobic digesters is directly associated with the raw sludge feeding. Maximum biogas production in anaerobic digesters fed at regular intervals along the day normally occurs 2 hours after each feeding.

The production rate of biogas may be estimated as $0.8 \text{ m}^3/\text{kg}$ volatile solids destroyed, which is equivalent to approximately **25 L/inhabitant·day**. Biogas density and thermal capacity vary with the composition. The higher the methane concentration in the biogas, the higher its heating value and the lower its density. A 70%-methane biogas has a heating power of approximately $23,380 \text{ kJ/m}^3$ (6.5 kW/m^3). As a simple comparison, natural gas, which is a mixture of methane, propane and butane, has a heating power of $37,300 \text{ kJ/m}^3$ (10.4 kW/m^3).

Biogas distribution pipes must be clearly identified and kept in good working order, and confined spaces along their route in the treatment plant must be avoided. Although regularly tested for leakages and no matter how careful the maintenance staff is, it is very difficult to prevent occasional leakages. Therefore, extreme precaution is vital when using potential ignition sources, such as welding and

Poor mixture for combustion	Inflammable mixture	Mixture too rich for combustion
LEL = 5%		UEL = 15%

Figure 49.5. Combustion potential as a function of the methane concentration in the biogas/air mixture

cutting apparatus. Filament bulbs should be protected. Small exhausts should be provided for control panels in poor ventilated areas crossed by sludge pipes to avoid accumulation of gas inside the control panel, which can lead to ignition when a switch button is pushed.

Explosion may only happen when a proper combination of biogas and air occurs in the presence of a heat source (e.g., spark) with a temperature above 700 °C (ignition temperature). As biogas and air are both naturally present in the vicinity of the sludge digesters and heat sources can not be completely eliminated from the digesters supporting units (control panels, furnaces etc.), it is highly advisable to prevent biogas-air mixture situations while designing the gas piping.

The right proportion for explosion happens when methane concentration in the mixture with air reaches 5–15% (Figure 49.5). The lower explosive limit (LEL) is the minimum methane concentration (5%) needed to explode a methane/air mixture exposed to ignition. Below LEL, the methane concentration is very poor for an explosion to take place. The upper explosive limit (UEL) is 15%. Above the UEL, there is not enough oxygen to provoke an explosion.

The main characteristics of the biogas components are summarised below in terms of safety aspects:

- *Methane* (CH₄) – odourless, colourless and inflammable between 5% LEL and 15% UEL. The relative density (0.55) is lower than air, being easily dispersed. It is not toxic, although at very high concentrations may reduce the air oxygen concentrations to asphyxiating levels.
- *Carbon dioxide gas* (CO₂) – odourless, colourless and non-inflammable. The relative density (1.53) is higher than air, being asphyxiating at concentrations above 2%.
- *Hydrogen sulphide* (H₂S) – colourless, inflammable and with a characteristic rotten-egg smell. It has a relative density (1.19) nearly equal to air and 4.3% LEL and 43.5% UEL. It is irritant and asphyxiating. Concentrations higher than 1% inhibit the olfactory system and leads to unconsciousness.

The typical composition of the biogas produced in anaerobic digesters is presented in Table 49.6.

49.2.9 Temperature and heat balance

The temperature inside anaerobic digesters should be kept near 35 °C for their good operational performance. This is especially true for cold climate regions, where raw sludge temperature may be lower than 15 °C.

Table 49.6. Typical composition of biogas generated in anaerobic digesters

Gas	% (volume/volume)
Methane	62–70
Carbon dioxide	30–38
Hydrogen sulphide	50–3,000 ppm
Nitrogen	0.05–1.0
Oxygen	0.022
Hydrogen	<0.01
Water vapour	Saturation

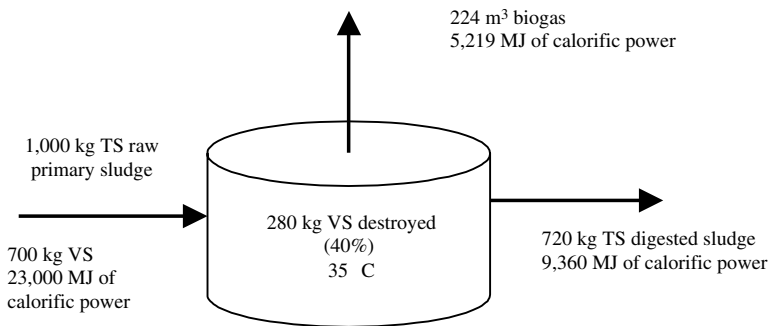

raw sludge heating power: 23 MJ/kgTS 1,000 kgTS = 23,000 MJ
amount of volatile solids destroyed: 700 kgTS 0.4 = 280 kg VS
amount of digested sludge: 1000 – 280 = 720 kgTS
digested sludge heating power: 13 MJ/kgTS 720 kgTS = 9,360 MJ
biogas production: 0.8 m³/kg VS destroyed
biogas volume produced: 280 kgVS 0.8 = 224 m³
biogas heating power: 23.3 MJ/m³ 224 m³ = 5,219 MJ

Figure 49.6. Example of a typical mass and heat balance during anaerobic sludge digestion

The **raw sludge** heating power ranges from **11** to **23 MJ/kgTS** on a dry-weight basis, depending upon the type of sludge and the concentration of volatile solids. The **digested sludge** has a lower heating power, which ranges from **6** to **13 MJ/kgTS** due to the smaller concentration of volatile solids.

A typical mass and heat balance within anaerobic digesters is shown in Figure 49.6.

Heating is necessary in cold weather climates to compensate for heat losses through the digesters outer surface and to raise the temperature of the raw sludge fed daily. Biogas can be used as a heat source for digester heating. Biogas is used to feed the furnace and heat the boiler, with the sludge heating indirectly accomplished by heat exchange units. In most cases, the system is self-sufficient and no further complementary external heating source is required, except during winter in very cold regions. An external heating source (e.g., fuel oil) is necessary only for the unit start-up.

The heat needed to keep anaerobic digesters near 35 °C – mesophilic digestion – is the heat needed to heat the incoming raw sludge plus the heat needed to compensate for heat losses through the digesters walls, cover and bottom. Thus:

$$Q = M_f \times C_p \times \Delta T_1 + H \quad (49.3)$$

where:

Q = sludge digester daily energy demand (kJ/d)

M_f = raw sludge mass fed to the digester (kg/d)

C_p = specific heat of water (kJ/kg.°C)

ΔT_1 = difference between the raw sludge temperature and the digester temperature (°C)

H = heat loss through the digester walls (kJ/d)

The daily heat loss through all the digester surface can be determined by:

$$H = U \times A \times \Delta T_2 \times 86.4 \quad (49.4)$$

where:

U = heat transfer coefficient (J/s.m².°C)

A = digester outer surface area (m²)

ΔT_2 = difference between the digester inner temperature and the outer temperature (°C).

- *Raw sludge mass fed to digester – M_f* : thermodynamically, a raw sludge up to 6% solids content may be considered water, with a density of 1 kg/L and specific heat (C_p) of 4.20 kJ/kg.°C.
- *Temperature difference – ΔT* : varies with the site climatic conditions. Inner digester temperature must remain between 35°C ± 3°C to assure mesophilic digestion conditions.
- *Heat transfer coefficient – U* : depends on the material used to build the digester tank. Literature gives U values of 2–3 J/s.m².°C for well-insulated digesters, whereas poorly insulated digesters may have U values of 3–5 J/s.m².°C.
- *Digester surface area – A* : includes side walls, cover and bottom area of digester tank.

Example 49.1

Design a primary anaerobic digester using data from Example 47.4.

Input data:

- Mixed sludge load to digester: 3,307 kgTS/d
- Influent sludge flow: $Q = 64.2 \text{ m}^3/\text{d}$
- VS/TS ratio = 0.77

Solution:

(a) *Digester volume*

Design parameters:

- Volatile solids loading rate (assumed, Table 49.5): $1.4 \text{ kgVS}/\text{m}^3 \cdot \text{d}$
- Volume reserved to the biogas in the digester: 15% of the volume needed for digestion

Volatile solids load: $3,307 \text{ kgTS}/\text{d} \times 0.77 \text{ kgVS}/\text{kgTS} = 2,546 \text{ kgVS}/\text{d}$
 Digesters volume (Equation 49.2): $(2,546 \text{ kgVS}/\text{d}) / (1.4 \text{ kgVS}/\text{m}^3 \cdot \text{d}) = 1,819 \text{ m}^3$

Reserved volume for biogas accumulation: $1,819 \times 0.15 = 273 \text{ m}^3$

Total digester volume: $1,819 + 273 = 2,092 \text{ m}^3$

(b) *Hydraulic detention time*

Hydraulic detention time (Equation 49.1)

$$t = \theta_c = 1,819 \text{ m}^3 / 64.2 \text{ m}^3/\text{d} = \mathbf{28 \text{ days}}$$

An economic assessment of the sludge digesters construction costs may suggest higher volatile solids loading rates, which would reduce the detention time to less than 25 days.

(c) *Primary digester effluent sludge (influent sludge to secondary digester)*

Influent TS = 3,307 kgTS/d

Influent VS = (VS/TS) \times Influent TS = $0.77 \times 3,307 = 2,546 \text{ kgVS}/\text{d}$

Influent FS = $(1 - \text{VS}/\text{TS}) \times \text{Influent TS} = (1 - 0.77) \times 3,307 = 761 \text{ kgFS}/\text{d}$

FS (fixed solids) do not change, but the VS are partially removed during digestion. According to Table 49.5, the removal efficiency of VS is between 40% and 55%. Assuming 50% (0.50) VS removal efficiency, the distribution

Example 49.1 (Continued)

of the effluent solids from the primary sludge digesters can be estimated as:

$$\text{Effluent FS} = \text{Influent FS} = 761 \text{ kgFS/d}$$

$$\begin{aligned} \text{Effluent VS} &= (1 - \text{VS removal efficiency}) \times \text{Influent VS} \\ &= (1 - 0.50) \times 2,546 = 1,273 \text{ kgVS/d} \end{aligned}$$

$$\text{Effluent TS} = \text{Effluent FS} + \text{Effluent VS} = 761 + 1,273 = 2,034 \text{ kgTS/d}$$

The sludge flow values for the primary digester effluent and influent are equal, so:

$$\text{Primary effluent sludge flow} = \text{Primary influent sludge flow} = \mathbf{64.2 \text{ m}^3/\text{d}}$$

The TS concentration in the primary sludge digesters effluent is:

$$\begin{aligned} \text{TS conc} &= \frac{\text{TS load}}{\text{Flow}} = \frac{2,034 \text{ kgTS/d} \times 1,000 \text{ g/kg}}{64.2 \text{ m}^3/\text{d}} \\ &= 31,682 \text{ g/m}^3 = 31,682 \text{ mg/L} = \mathbf{3.17\%} \end{aligned}$$

(d) Heat balance in digester

Raw sludge calorific power: 23 MJ/kgTS (assumed, Table 49.5)

Digested sludge calorific power: 13 MJ/kgTS (assumed, Table 49.5)

Biogas production: 0.8 m³/kgVS destroyed (assumed, Table 49.5)

Biogas calorific power: 23.3 MJ/m³ (assumed, Table 49.5)

Volatile solids destroyed: 1,273 kgVS/d (see Item c)

Effluent digested sludge: 2,034 kgTS/d (see Item c)

Biogas volume: 1,273 kgVS/d × 0.8 m³/kgVS = 1,018 m³/d

Calorific power of the raw sludge entering the digester: 3,307 kgTS/d × 23 MJ/kgTS = 76,061 MJ/d

Calorific power of biogas: 1,018 m³/d × 23.3 MJ/m³ = 23,719 MJ/d

Calorific power of digested sludge: 2,034 kgTS/d × 13 MJ/kgTS = 26,442 MJ/d

49.2.10 Operation and control of anaerobic sludge digesters

Operators responsible for a wastewater treatment plant know that a high level of operational performance and a peaceful ending of a daily shift may depend upon simple, easily understandable operational routines. As far as anaerobic sludge digesters operation is concerned, a good performance can be assured whenever the following factors are taken into consideration:

- suitable frequency of feeding;
- detention time higher than the methanogenic organisms growth rate;
- good operational conditions of the mixing system, assuring homogeneity inside the digester tank.

Table 49.7. Volatile acids and alkalinity ratio

Volatile acids/alkalinity ratio	Indication
<0.3	Digester is working well
0.3–0.5	Failure in digestion process
>0.8	Digestion has become acid and process collapse is imminent

Volatile acids concentration and alkalinity within the digester are closely related to each other, and the volatile acids/alkalinity ratio is a very good indicator of the quality of the digestion process. Values below 0.3 indicate good conditions within the digester, while values between 0.3–0.5 suggest deficiencies in the digestion process and call for immediate attention of the plant operator. If this ratio reaches values higher than 0.8, the digester has become acid and process collapse is imminent (Table 49.7).

Occasionally, the anaerobic digestion process may become unstable and eventually lead the digester to collapse. The instability in anaerobic digesters occurs when the series of biochemical reactions described in this chapter happens without the necessary synergy. Acid-forming bacteria outweigh the acid-consuming organisms, increasing the concentration of acids and reducing the pH in the medium. Although the causes may be varied, the instability symptoms of digestion process are common and include:

- increase of the volatile acids concentration;
- reduction of pH and alkalinity;
- reduction of methane production;
- increase of CO₂ concentration in biogas.

In such situations, the sequence of events inside the digester can be outlined as follows:

- The volatile acids/alkalinity ratio in the digested sludge reaches values above 0.3 because the volatile acids concentration has increased;
- The volatile acids start to consume alkalinity, releasing CO₂, which reduces the methane concentration and hence the biogas calorific power. The volatile acids/alkalinity ratio keeps increasing, reaching values of 0.5–0.8;
- The pH is reduced to values lower than 6.5, inhibiting methane production. The digester becomes acidified and collapses.

The collapse process described above is not immediate, taking some days to get accomplished. Therefore, it is possible to avoid it, following some measures such as:

- Through control data of the digester it is possible to determine the reasons for the process instability. A fast methanogenic process inhibition suggests the presence of highly concentrated toxic substances. A gradual inhibition indicates the presence of low-concentration toxic substances or electrical–mechanical operation problems (e.g., inoperative mixing

system). A direct intervention of the maintenance staff is recommended for electrical–mechanical problems.

- The influent organic load must be verified to see if it is not above the digester capacity, since excess of organic load favours acid production and pH reduction. If the organic load is higher than recommended, feeding must be reduced until the equilibrium in the medium is reached. During digesters start-up or after maintenance periods, excessive load is a usual occurrence and acidification may happen.
- Neutral pH must be maintained through the addition of alkaline solution to the raw sludge. Should toxic substances be found in the raw sludge, dilution with non-contaminated sludge or even interruption of feeding may be carried out.
- If there is an excess of metals, sodium sulphide may be added to precipitate metallic cations. In this case, pH must be kept over 7.5, avoiding H₂S formation. The concentrations of soluble sulphides must be monitored and shall not exceed 100 mg/L.
- It may be advisable to feed anaerobic sludge from another anaerobic digester operating under stable conditions.

Feeding of the digester can be gradually brought to normal rates as soon as the digestion process shows signs of recovery.

Occasionally, the digester needs to be taken out of service for maintenance or removal of inert material deposits. The characteristics of the biogas and the amount of sludge involved require a carefully planned operation, to avoid accidents or a decrease in the plant operational performance. As previously mentioned, it is necessary to avoid an explosive biogas-air mixture inside the digester, so safety standards must be fulfilled and only skilled personnel must participate in the operation.

The following procedure can be adopted, should the anaerobic digester be taken out of service:

- stop sludge feeding
- transfer as much sludge as possible to other digesters (if existent)
- monitor gas production until it becomes negligible
- stop the mixing and heating systems
- isolate the gas outlet pipes
- if possible, complete the level of the digester with final effluent
- be sure that the methane concentration in the gas compartment is lower than 3%
- otherwise, inject nitrogen until methane concentration is reduced down to values lower than 3%
- remove the remaining mixture in the digester, taking it to dewatering or to the treatment plant headworks
- remove vent and access flanges
- start the cleaning operation

Table 49.8. Main causes of anaerobic sludge digesters collapse and corrective measures

Promoting factors of instability and consequences			Symptoms	Recommended measures
Hydraulic shock	Organic shock	Toxic load		
Excessive sludge production	Increase in sludge influent to digester	Excessive concentration of heavy metals	Increase in volatile acids concentration	Adjust alkalinity through addition of alkaline solution (e.g., lime)
Very dilute sludge in feeding	Increase of solids concentration in the influent to digester	Excessive detergent load	Alkalinity reduction pH reduction	Lower volatile acids/alkalinity ratio to <0.5
Digester silting	Change in sludge characteristics	Chlorinated organic compounds in sludge	Increase in volatile acids/alkalinity ratio	Regulate feeding routine
Excessive foam	Too fast digester start-up	Addition of oxygen	Reduction of gas production	Raise sludge concentration Restrict industrial influent to WWTP
Methanogenic organisms wash-out	Irregular feeding	Excessive sulphides	Increase in CO ₂ concentration in biogas	Clean the digester Initiate a new start-up protocol

Table 49.9. Main parameters and recommended operational ranges for anaerobic digesters

Parameter	Recommended value
PH	7.0–7.2
Alkalinity (mg/L CaCO ₃)	4,000–5,000
Volatile acids (mg/L HAc)	200

Table 49.8 summarises the main causes of anaerobic digester failure, symptoms and corrective measures.

49.2.11 Monitoring of the anaerobic digester

Sampling must be performed fortnightly (or monthly) aiming at the evaluation of the internal conditions within the digester. Under normal conditions, pH remains nearly neutral in the 7.0–7.2 range, alkalinity (as CaCO₃) at 4,000–5,000 mg/L, and volatile acids concentration (expressed as acetic acid) below 200 mg/L (Table 49.9). Determination of the volatile acids/alkalinity ratio, as well as data on biogas production and composition, help identify digester overloading or operational inhibitions.

Knowledge of the volatile acids composition through chromatography may also help in the digester diagnosis. Digester operation is clearly unstable if the concentration of long-chain volatile acids increase (e.g., butyric acid) compared to the concentration of short-chain volatile acids (e.g., acetic acid).

49.3 AEROBIC DIGESTION

49.3.1 Introduction

The aerobic digestion process has a great similarity with the activated sludge process. With the supply of substrate interrupted, the microorganisms are forced to consume their own energy reserves to remain alive. This is the so-called endogenous phase, where, in the absence of food supply, the biodegradable cell mass (75%–80%) is aerobically oxidised to carbon dioxide, ammonia and water. During the reaction, ammonia is oxidised to nitrate, according to the following general equation:

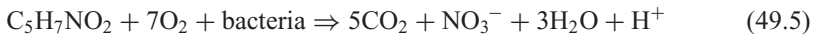

Aerobic digestion is used in activated sludge plants operating in the extended aeration mode, as well as in plants with biological nutrient removal (BNR). Sludge digestion in extended aeration processes takes place in the aeration tank, simultaneously with the oxidation of the influent organic matter process, because the food/microorganism (F/M) ratio is low. Wasted excess activated sludge in BNR processes shall not become anaerobic, otherwise, the excess phosphorus accumulated

within the cell mass during the treatment process will be released as soluble orthophosphate. Under such circumstances the recommended digestion process is the aerobic digestion, which is undertaken separately, in aerobic digesters.

Currently, three types of aerobic digestion processes are used in sludge stabilisation:

- conventional aerobic digestion (mesophilic);
- aerobic digestion with pure oxygen;
- thermophilic aerobic digestion.

Differently from the anaerobic digester, the aerobic sludge digester environment is oxidant (positive redox potential). It is advisable to control the redox potential throughout the reaction process aiming to assure oxidising conditions within the digester tank. This can be achieved through a continuous potentiometer.

Aerobic sludge digesters performance depends upon the concentration of sludge and on the volume of oxygen supplied. Solids concentrations higher than 3% in conventional digesters jeopardise the oxygen transfer efficiency of the system, hampering the assimilation of oxygen by microorganisms and fostering the build-up of a reducing environment in the core of the bacterial floc. If this happens, anaerobic digestion prevails and foul odours are released. In pure oxygen digesters, solids concentration may become as high as 5%.

49.3.2 Conventional aerobic digestion

Conventional aerobic digestion stabilises the activated excess sludge in unheated open digesters through diffused air or surface mechanical aeration. The digestion occurs at a mesophilic temperature range. Sludge is usually thickened by flotation to reduce the required digestion volume. As previously mentioned, solids concentrations in the aerobic digesters should not be greater than 3%.

Aspects to be considered in the design of aerobic digesters are similar to those for activated sludge systems, such as:

- hydraulic detention time (t) which, in this case, is equal to the solids retention time, or sludge age (θ_c)
- organic loading
- oxygen demand
- power requirements (enough for supplying the oxygen demand and maintaining the sludge in suspension)
- temperature

The main design parameters for conventional aerobic sludge digesters are shown in Table 49.10.

- *Hydraulic detention time.* After 10–15 days of detention time, under a temperature around 20 °C, the concentration of volatile solids in the sludge is reduced by 40%. Higher detention time and temperature shall be provided to achieve reductions beyond 40% solids.

Table 49.10. Design parameters for conventional aerobic sludge digesters

Item	Parameter	Value
Hydraulic detention time (d) 20 °C	Excess activated sludge	10– 15
	Extended aeration	12–18
	Excess activated sludge + primary sludge	15–20
Organic loading rate (kgVS/m ³ d)	–	1.6–4.8
Oxygen demand (kgO ₂ /kgVS destroyed)	Endogenous respiration	~2.3
	BOD in primary sludge	1.6–1.9
Energy for keeping solids in suspension	Mechanical aerators (W/m ³)	20–40
	Diffused air (L/m ³ min)	20–40
DO in digester (mg/L)	–	1–2

VS = volatile solids

Source: Adapted from Metcalf and Eddy (1991)

- *Organic loading.* The organic loading is limited by the oxygen transfer capacity of the aeration system. Solids concentrations higher than 3% may lead to anaerobic conditions. Typical values for organic loadings are 1.6–4.8 kgVS/m³d.
- *Oxygen demand.* Oxygen supply must meet cell mass endogenous respiration needs and promote mixing conditions within the digester tank. The oxygen stoichiometric demand (Equation 49.5) necessary to oxidise the organic matter in sludge is 7 mols O₂/mol of cells, or approximately 2.3 kg O₂/kg of destroyed cells. The concentration of dissolved oxygen in the reactor must be kept within 1–2 mg/L. Operational data indicate that a sludge digested under such conditions is easily mechanically dewatered.
- *Mixing.* Good mixing is essential to ensure the stabilisation of the sludge in aerobic digesters. In diffused air systems, the flow for mixing is approximately 30 L air/m³·minute, normally attained by the oxygen demand for stabilisation itself.
- *Temperature.* The solids reduction rate depends upon the temperature inside the digester: the higher the temperature, the higher is the organic matter conversion rate. Stabilisation virtually stops if temperatures fall below 10 °C. Temperature is not controlled in conventional aerobic digesters, although heat loss can be minimised in partially buried concrete tanks. Sub-surface aerators may also help to keep temperature under control.

The following parameters are utilised for assessing the operational performance of aerobic digesters:

- volatile solids reduction
- quality of supernatant
- sludge dewaterability
- odour and aspect of the digested sludge

Volatile solids reductions in aerobic digesters of 35–50% can be normally obtained with 10–15 days of detention time. If coliforms removal is a goal, the hydraulic detention time must be greater than 40 days.

Supernatant quality is a significant item in activated sludge plants designed for biological nutrient removal. Anaerobic conditions may lead to phosphorus release from the bacterial cell mass to the supernatant liquid, which is recycled back to the plant headworks, hindering the phosphorus removal effort.

Although the dewaterability of the aerobic sludge remains controversial, practical experiences have shown that it is harder to dewater than anaerobic sludge, mainly because of the destruction of the floc structure during the endogenous respiration process.

The reduction of pathogens and ammonia concentrations in the digested sludge is also a good indicator of the quality of the stabilisation process.

Example 49.2

Design an aerobic digester tank using data from Example 47.4. In the present example, only the excess activated sludge will be routed for aerobic digestion.

Input data (according to Example 47.4):

- Secondary sludge removal point: sludge recirculation line
- Excess SS load: 1,659 kgSS/d
- SS concentration in the excess sludge: 7,792 mg/L (0.78%)
- Excess sludge flow: $Q_{\text{ex}} = 213 \text{ m}^3/\text{d}$

Data from the thickened sludge (assume mechanical thickening):

- SS capture in thickener: $0.9 = 90\%$
- Influent SS load to digester: $1,659 \text{ kgSS/d} \times 0.9 = 1,493 \text{ kgSS/d}$
- VSS/SS ratio in excess sludge: $0.77 = 77\%$
- Influent VSS load to digester: $1,493 \text{ kgSS/d} \times 0.77 \text{ kgVSS/kgSS} = 1,150 \text{ kgVSS/d}$
- SS concentration in thickened excess sludge: $40,000 \text{ mgSS/L} = 40 \text{ kgSS/m}^3 = 4.0\%$
- Thickened sludge flow: $Q_{\text{ex}} = 1,493 \text{ kgSS/d} / 40 \text{ kgSS/m}^3 = 37.3 \text{ m}^3/\text{d}$
- Temperature: 20°C

Design parameters:

- Digester hydraulic detention time: 15 days
- Oxygen demand: $2.3 \text{ kg O}_2/\text{kg VS destroyed}$
- Air density: 1.2 kg/m^3
- Oxygen concentration in the air: 23%

Example 49.2 (Continued)**Solution:**(a) *Volume of the aerobic digester*

$$V = 37.3 \text{ m}^3/\text{d} \times 15 \text{ d} = \mathbf{560 \text{ m}^3}$$

(b) *Solids loading rate*

$$\text{Volatile solids loading} = 1,150 \text{ kgVSS/d} / 560 \text{ m}^3 = \mathbf{2.1 \text{ kgVS/m}^3 \cdot \text{d}}$$

(OK – within range of Table 49.10)

(c) *Effluent sludge from aerobic digester*

$$\text{Influent TS} = 1,493 \text{ kgTS/d}$$

$$\text{Influent VS} = 1,150 \text{ kgVS/d}$$

$$\text{Influent FS} = \text{TS} - \text{VS} = 1,493 - 1,150 = 343 \text{ kgFS/d}$$

FS (fixed solids) remain unchanged during digestion, whereas VS are partially removed. Assuming 40% VS removal efficiency in aerobic digestion, the solids load may be computed as:

$$\text{Effluent FS} = \text{Influent FS} = 343 \text{ kgFS/d}$$

$$\begin{aligned} \text{Effluent VS} &= (1 - \text{VS removal efficiency}) \times \text{Influent VS} \\ &= (1 - 0.40) \times 1,150 = 690 \text{ kgVS/d} \end{aligned}$$

$$\text{Effluent TS} = \text{Effluent FS} + \text{Effluent VS} = 343 + 690 = 1,033 \text{ kgTS/d}$$

VS destroyed load is:

$$\begin{aligned} \text{Destroyed VS load} &= (\text{VS removal efficiency}) \times \text{Influent VS load} \\ &= (0.40) \times 1,150 = 460 \text{ kgVS/d} \end{aligned}$$

The effluent flow from the aerobic digester is equal to the inflow, so:

$$\begin{aligned} \text{Aerobic digester effluent sludge flow} &= \text{Aerobic digester influent sludge flow} \\ &= \mathbf{37.3 \text{ m}^3/\text{d}} \end{aligned}$$

The SS concentration in the aerobic digester effluent sludge is:

$$\begin{aligned} \text{SS conc} &= \frac{\text{SS load}}{\text{Flow}} = \frac{1,033 \text{ kgSS/d} \times 1,000 \text{ g/kg}}{37.3 \text{ m}^3/\text{d}} \\ &= 27,694 \text{ g/m}^3 = 27,694 \text{ mg/L} = \mathbf{2.77\%} \end{aligned}$$

This is the same SS concentration maintained in the aerobic digester tank. It should be noticed that this concentration is lower than 3%. Oxygen transfer to biomass is hampered for values above this limit.

Example 49.2 (Continued)*(d) Air demand*

- Oxygen mass = VS load destroyed \times O₂ demand = 460 kgVS destroyed \times 2.3 kgO₂/kgVS = 1,058 kgO₂/d (at field conditions)
- Volume of air = (1,058 kgO₂/d)/(1.2 kgO₂/m³ \times 0.23) = 3,833 m³/d

Air demand, assuming 10% oxygen transfer efficiency:

- Air flow needed = 3,833/0.10 = **38,330 m³/d**
- Check air flow mixing capacity: (38,330 m³/d)/(560 m³) = 68 m³ air/m³·d = 47 L/m³·min (OK – greater than minimum flow needed to keep solids in suspension, see Table 49.10)
- O₂ consumption at standard conditions (assuming ratio O₂ field/O₂ standard = 0.55):

$$1,058 \text{ kgO}_2/\text{d}/0.55 = 1,924 \text{ kgO}_2/\text{d} = 80 \text{ kgO}_2/\text{hour (standard)}$$

(e) Required power

Assuming an Oxygenation Efficiency OE_{standard} = 1.6 kgO₂/kWh (see Chapter 11 for the concept of OE):

- Power = (80 kgO₂/hour)/(1.6 kgO₂/hour) = 50 kW = 68 HP

49.3.3 Aerobic digestion with pure oxygen

Aerobic digestion using pure oxygen is a variant from the conventional aerobic digestion, in which oxygen instead of air is directly supplied to the medium. The concentration of solids in the digester may be as high as 4% without any reduction in the oxygen transfer rate to the biomass.

This process is suitable for large wastewater treatment plants, where area is a prime factor, and in which pure oxygen is already being used in the biological reactor. The reaction is highly exothermic, increasing the process efficiency and favouring its use in cold-climate regions.

49.3.4 Thermophilic aerobic digestion

Section 51.4.3 also discusses the thermophilic aerobic digestion process, analysed in terms of the disinfection of the sludge.

Heat is the main by-product from the organic matter aerobic digestion process, and the temperature inside the digester can reach 60 °C, provided there is enough substrate to keep the microbiological activity.

Thermophilic aerobic digestion (TAD) started in Germany in the early 1970s aiming at the stabilisation and disinfection of sewage sludges. In the early days

it was believed that thermophilic temperatures could only be reached through the use of pure oxygen. However, later experiments proved that the use of plain air should pose no problem in reaching high temperatures in the process.

Sludges from thermophilic aerobic digesters comply with class “A” biosolids rating of the US Environmental Protection Agency (USEPA), and can be unrestrictedly used in agriculture.

The process is able to stabilise about 70% of the biodegradable organic matter in the sludge after a period of only three days. To assure an autothermic reaction process, the sludge fed to the digester must have a minimum concentration of 4%, with a solids loading rate of about 50 kg TS/m³ digester and an organic loading rate of 70 kg BOD/m³ digester.

The main advantages of thermophilic aerobic digestion are:

- reduction of the hydraulic detention time (volume of the digester) for organic matter stabilisation;
- production of a disinfected sludge meeting USEPA biosolids rating for unrestricted reuse.

The main disadvantages of the process are:

- high capital cost;
- operational complexity;
- foam build-up on the digester surface. A freeboard of 30% of the digester height is recommended to accommodate the produced foam.

TAD’s future is promising, mainly due to the increasing restraining measures for the agricultural reuse of sludge. The process still requires development, especially in terms of operational control.

49.3.5 Composting

Section 51.4.2 describes in more detail the composting process, including a design example, discussed from the perspective of pathogens removal.

Composting is an organic matter stabilisation process used by farmers and gardeners since ancient times. The composting of human faeces (night soil) is traditionally performed in China, being considered the most likely reason why fertility and structure of Chinese soil is being maintained for over 5,000 years.

The composting processes may be divided into:

- windrow composting – the simplest and most traditional composting process;
- aerated static pile composting;
- closed-reactor biological composting, or in-vessel composting.

Although versatile, sewage sludge composting demands experience and professionalism, either in the design phase, or in the operational phase.

Composting consists in the decomposition of organic matter by mesophilic and thermophilic aerobic microorganisms. Process temperatures may reach 80 °C, after

which the organic matter degradation rate is reduced and the temperature quickly drops down to 60 °C. In the turned-over windrow system, the sludge is arranged in windrows with variable lengths, with the base and height varying between 4.0–4.5 m and 1.5–1.8 m, respectively. Windrows are arranged in open areas and aeration is done both through natural convection and diffusion of air, and through regular turning-over by bulldozers or equipments specifically designed for this purpose.

The main requirements for a good composting are:

- nutrients in the sludge must be balanced with a carbon:nitrogen ratio in the range of (20–30):1.
- continuous air supply should be provided to keep an oxidising environment inside the windrow. The type of material used as bulking agent is essential in this aspect. Should anaerobic digestion conditions arise within the stack, low-molecular weight volatile organic acids (propionic, butyric and acetic acids) may be generated and foul odours may be released.
- heat loss control must assure 55–65 °C for the temperature inside the windrow.
- enough moisture shall be kept within the stack. Microbiological activity is drastically reduced when moisture drops below 35–40%. However, values above 65% interfere with the aerobic digestion process, calling for sludge dewatering (>35% dry solids) prior to composting.

Due to the exothermic characteristic of the process, the heat produced within the windrow is gradually released to the atmosphere, decreasing overall moisture of the material and inactivating pathogenic organisms. To maintain a balanced stabilisation process, the windrow must be regularly turned-over, so that the material on the outer surface is incorporated within the stack.

The main bulking agents used in sewage sludge composting are urban household organic wastes and the so-called green wastes, originating from tree pruning and lawn mowing. The co-composting of these materials has the disadvantage of increasing the volume to be composted, demanding additional area availability at the wastewater treatment plant or at the solid wastes recycling plants.

Figure 49.7 shows the flowsheet of a composting process.

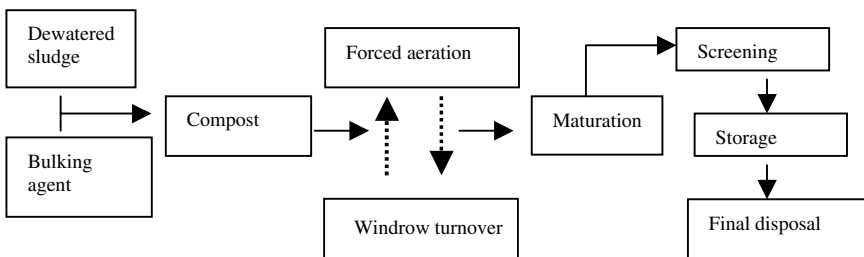

Figure 49.7. Flowsheet of a composting process

The main advantages of the composting process are:

- high-quality final product, widely accepted in farming
- possible combined use with other stabilisation processes
- low capital cost (traditional composting)

The main disadvantages are:

- need for a sludge with high-solids concentration (>35%)
- high operational costs
- need for turning-over and/or air-generation equipments
- considerable land requirements
- foul-odour generating risk

49.3.6 Wet air oxidation and incineration

Although these processes also stabilise the organic matter during the reaction process, they are discussed separately in Chapter 54.

50

Sludge thickening and dewatering

R.F. Gonçalves, M. Luduvic, M. von Sperling

50.1 THICKENING AND DEWATERING OF PRIMARY AND BIOLOGICAL SLUDGES

50.1.1 Preliminary considerations

A general description of the main processes used for thickening and dewatering were previously presented in Sections 5.5 and 5.7, where comparisons among the processes were made, including a balance of advantages and disadvantages. The reader is referred to these sections, which are the basis for the understanding of the present chapter.

Since the main objective of sludge thickening and dewatering is reduction of the water content in the sludge to reduce its volume, both operations are treated together in this chapter. Conditioning of the sludge, aiming at improving water removal and solids capture is also analysed. Therefore, this chapter covers the following topics and processes:

- *introductory aspects*
- *sludge thickening*
 - gravity thickeners
 - dissolved air flotation thickeners

- *sludge conditioning*
 - introductory aspects
 - organic polymers
 - inorganic chemical conditioning
- *sludge dewatering*
 - introductory aspects
 - sludge drying beds
 - centrifuges
 - filter presses
 - belt presses

An overview of all the above processes, including a general description, design criterion and operating principles is provided.

50.1.2 Water in sludge

The removal of the water content is a fundamental unit operation for the reduction of the sludge volume to be treated or disposed of. Water removal takes place in two different stages of the sludge processing phase:

- thickening
- dewatering

Sludge thickening is mainly used in primary treatment, activated sludge and trickling filter processes, having large implications on the design and operation of sludge digesters. Sludge dewatering, carried out in digested sludge, impacts sludge transportation and final disposal costs. In both cases, water removal influences sludge processing, since the mechanical behaviour of sludge depends upon its solids content.

The main reasons for sludge dewatering are:

- reduction of transportation costs to the final disposal site
- improvement in the sludge handling conditions, since the dewatered sludge is more easily conveyed
- increase in the sludge heating capacity through the reduction of the water prior to incineration
- reduction of volume aiming landfill disposal or land application
- reduction of leachate production when landfill disposal is practised

Intermolecular forces of different types are responsible for water bonding to sludge solids. Four distinct classes may be listed, according to the ease of separation:

- *free water*
- *adsorbed water*
- *capillary water*
- *cellular water*

The removal of *free water* is accomplished in a consistent way by simple gravitational action or flotation. This is what happens in gravity thickeners, where a

2% TS influent sludge leaves the unit with a solids concentration of up to 5%, leading to a sludge volume reduction of 60% or more. Another example of free water removal is the initial stage of sludge dewatering in drying beds, characterised by a rapid water loss due to percolation. *Adsorbed water* and *capillary water* demand considerably larger forces to be separated from the solids in sludge. These forces may be either chemical, when flocculants are used, or mechanical, when mechanical dewatering processes such as filter presses or centrifuges are employed. Solids contents higher than 30% may be obtained, resulting in a final product known as **cake**, with a semi-solid appearance and having a consistency compatible with spade manipulation or conveyor belt transfer. The removal of free, adsorbed and capillary water from sludge (originally at 2% TS) may result in 90–95% reduction of the original volume.

Cellular water is part of the solid phase and can only be removed through thermal forces that lead to a change in the state of aggregation of the water. Freezing and mainly evaporation are two different possibilities for cellular water separation. The thermal drying process is one of the most efficient manners for the removal of water from cakes currently available, and a 95% solids content grain-like final product can be obtained.

50.2 SLUDGE THICKENING

50.2.1 Gravity thickening

Gravity thickeners have a similar structure to sedimentation tanks. Usually they are circular in shape, centre-fed, with bottom sludge withdrawal and removal of supernatant over their perimeter. Thickened sludge is directed to the next stage (usually digestion), whereas the supernatant returns to the plant headworks. Figure 50.1 shows the schematics of a gravity thickener.

The sludge behaviour within the thickener follows the principles of zone settling and the solids flux theory, discussed in Chapter 10. Tank sizing may be done based upon these principles or through solids and hydraulic loading rates. Table 50.1 presents typical solids loading rates as a function of the type of sludge to be thickened.

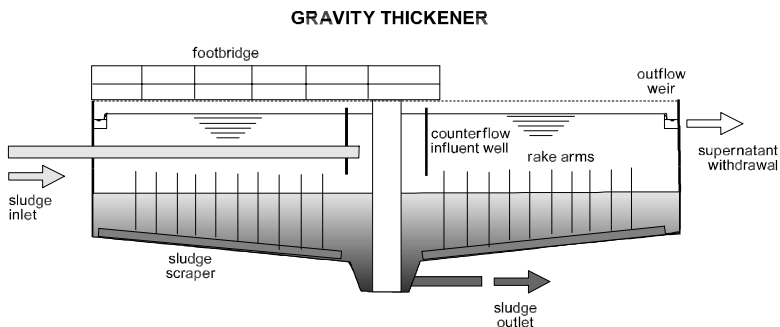

Figure 50.1. Schematic cross section of a gravity thickener

Table 50.1. Solids loading rates for the design of gravity thickeners

Source of sludge	Type of sludge	Solids loading rate (kgTS/m ² ·d)
Primary	–	90–150
Activated sludge	Conventional	20–30
	Extended aeration	25–40
Trickling filter	–	35–50
Mixed sludge	Primary + activated sludge	25–80
	Primary + trickling filter	<60

Sources: WEF/ASCE (1992); Jordão and Pessoa (1995); Qasim (1985)

Hydraulic loading is important in controlling excessive detention times, which could lead to the release of foul odours. Loading rates ranging from 20–30 m³/m²·d are therefore recommended. These values are not always achieved with the influent sludge, and final effluent recycling to the thickener is usually practised to increase the influent flow, thereby decreasing the hydraulic detention time. This flow increment is not detrimental to the thickener performance (Jordão e Pessoa, 1995).

Additional parameters according to Brazilian design standards NB-570 (ABNT, 1989) are:

- minimum sidewater height: 3.0 m
- maximum hydraulic detention time: 24 hours

Example 50.1

Design the gravity thickening unit of the conventional activated sludge system from Example 47.2.

Data:

- Population: 100,000 inhabitants
- Type of sludge: mixed (primary + activated sludge)
- Solids load in influent sludge: 7,000 kgTS/d
- Influent sludge flow: 600 m³/d

Solution:

(a) *Computation of the required surface area*

From Table 50.1, the solids loading rate (SLR) may be adopted as 40 kgTS/m²·d. The required area is:

$$\text{Area} = \frac{\text{Solids load}}{\text{Solids loading rate}} = \frac{7,000 \text{ kgTS/d}}{40 \text{ kgTS/m}^2 \cdot \text{d}} = 175 \text{ m}^2$$

Example 50.1 (Continued)*(b) Verification of the hydraulic loading rate*

The resulting hydraulic loading rate (HLR) is:

$$\text{Hydraulic loading rate} = \frac{\text{Flow}}{\text{Area}} = \frac{600 \text{ m}^3/\text{d}}{175 \text{ m}^2} = 3.4 \text{ m}^3/\text{m}^2 \cdot \text{d}$$

This value is lower than the range of 20–30 m³/m²·d, recommended to avoid septic conditions in the thickener. Assuming a HLR of 20 m³/m²·d, the following flow is needed:

$$\text{Flow} = \text{HLR} \times \text{Area} = 20 \text{ m}^3/\text{m}^2 \cdot \text{d} \times 175 \text{ m}^2 = 3,500 \text{ m}^3/\text{d}$$

As the available influent sludge flow is 600 m³/d, an additional 2,900 m³/d (= 3,500 – 600) of final effluent recycled flow is required to increase the HLR.

(c) Dimensions

Number of thickeners: $n = 2$ (assumed)

Area of each thickener = Total area/ $n = 175 \text{ m}^2/2 = 87.5 \text{ m}^2$

Thickener diameter:

$$D = \sqrt{\frac{4 \cdot A}{\pi}} = \sqrt{\frac{4 \times 87.5 \text{ m}^2}{3.14}} = 10.6 \text{ m}$$

Sidewater depth: $H = 3.0 \text{ m}$ (assumed)

Total volume of thickeners: $V = A \times H = 175 \text{ m}^2 \times 3.0 \text{ m} = 525 \text{ m}^3$

(d) Verification of the hydraulic retention time

The hydraulic retention time (HRT) is:

- Without final effluent recirculation: $\text{HRT} = V/Q = (525 \text{ m}^3)/(600 \text{ m}^3/\text{d}) = 0.88 \text{ d} = 21 \text{ hours}$ (OK, less than 24 hours)
- With final effluent recirculation: $\text{HRT} = V/Q = (525 \text{ m}^3)/(3,500 \text{ m}^3/\text{d}) = 0.15 \text{ d} = 3.6 \text{ hours}$ (OK, less than 24 hours)

50.2.2 Dissolved air flotation thickening

In the dissolved air flotation process, air is forced into a solution kept under high pressure. Under such conditions, the air remains dissolved. When depressurisation occurs, dissolved air is released, forming small bubbles, which, when rising, carry sludge particles towards the surface, from where they are skimmed off.

Table 50.2. Typical solids loading rates for dissolved air flotation thickening

Type of sludge	Solids loading rate (kgTS/m ² ·d)	
	Without chemicals	With chemicals
Primary sludge	100–150	≤300
Activated sludge	50	≤220
Trickling filter sludge	70–100	≤270
Mixed sludge (primary + activated sludge)	70–150	≤270
Mixed sludge (primary + trickling filter)	100–150	≤300

Source: Metcalf and Eddy (1991)

Flotation thickening is widely applicable for excess activated sludge, which does not thicken satisfactorily in gravity thickeners. Dissolved air flotation is also used in treatment plants where biological phosphorus removal is practised. In these plants sludge should be kept under aerobic conditions to avoid particulate phosphorus from being released back into the liquid phase as dissolved phosphorus.

Solids loading rates used in the design of dissolved air flotation tanks are usually higher than those for gravity thickeners. Typical loading rates are shown in Table 50.2, the lower values being recommended for design purposes.

Polymers can be used in an effective way, increasing the solids capture in floated sludge. Typical dosages are between 2 and 5 kg of dry polymers per metric ton of TS.

50.3 SLUDGE CONDITIONING

50.3.1 Effects of conditioning processes

Sludge conditioning is carried out before dewatering and directly influences the processes efficiency. Conditioning may be accomplished through the utilisation of inorganic chemicals, organic chemicals or thermal treatment. The main options for conditioning and their effects on mixed sludge (primary and activated sludges) dewatering are summarised in Table 50.3.

50.3.2 Factors affecting conditioning

Conditioning aims to change the size and distribution of particles, surface charges and sludge particles interaction. The degree of hydration and the demand for chemicals and resistance to dewatering increase with the specific surface of the particles. Figure 50.2 shows relative sizes of particles from different materials.

A significant presence of colloids and thin particles with diameters normally ranging from 1 μ to 10 μ is very common in sewage sludges. Biomass plays a significant role in the capturing of these particles during biological treatment, diminishing sludge dewaterability and increasing the consumption of conditioning chemicals.

The main purpose of sludge conditioning is to increase particle sizes, entrapping the small particles into larger flocs. This is accomplished through coagulation

Table 50.3. Effects of conditioning processes

Item	Inorganic chemicals	Organic chemicals	Heating
Conditioning mechanism	Coagulation and flocculation	Coagulation and flocculation	Changes surface properties, splits cells, releases chemicals and causes hydrolysis
Effect on allowable solids load	Allows loading increase	Allows loading increase	Allows significant loading increase
Effect on supernatant flow	Increases solids capture	Increases solids capture	Significantly increases colour, SS, filtered BOD, N-NH ₃ and COD
Effect on human resources	Small effect	Small effect	Requires skilled personnel and a consistent maintenance schedule
Effect on sludge mass	Significantly increases	None	Reduces existing mass, but may increase the mass through recirculation

Source: EPA (1987)

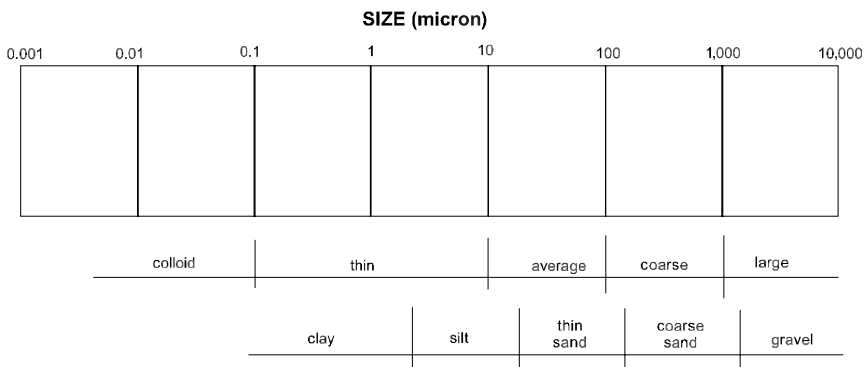

Figure 50.2. Distribution of particles size in the commonest materials (source: EPA, 1987)

followed by flocculation. Coagulation destabilises the particles, decreasing the intensity of the electrostatic repulsion forces among them. The compression of the electric double layer that surrounds each particle facilitates their mutual attraction. Flocculation allows the agglomeration of colloids and thin solids through low mixing gradients.

The amount of conditioning product to be used may vary with the sludge characteristics and the dewatering equipment adopted. The water content and the level of fine solids may change depending upon the type of sludge transportation through pipes and the storage period (weekends and longer periods). These factors affect the sludge characteristics and influence the demand for conditioners prior to dewatering.

50.3.3 Organic polymers

50.3.3.1 Main characteristics

Organic polymers are widely used in sludge conditioning. A variety of different products regarding chemical composition, performance and cost-effectiveness are available. The main advantages of organic polymers over chemical conditioners are:

- reduced sludge mass increase when compared with the mass increment when chemical conditioners are used (15–30%)
- cleaner handling operation
- reduced maintenance and operational problems
- no reduction of the calorific value of the dewatered sludge, which may be used as a fuel for incineration

Organic polymers dissolve in water to make up solutions with different viscosities. The resulting viscosity depends on their molecular weight, ionisation charge and dilution of water salt content. It is estimated that a 0.2 mg/L dosage of polymer with molecular weight of 100,000 contains around 120×10^9 active polymeric chains per litre of treated water (EPA, 1987). Polymers in solution act through attachment to the sludge particle, causing the following sequence:

- desorption of surface water
- neutralisation of charges
- agglomeration of small particulated matter through bridges among particles (bridging)

The selection of the suitable polymers should be done through routine and continuous tests involving the treatment plant operational staff and polymer suppliers. Due to changes in the characteristics of the produced sludge, tests should be carried out, whenever possible, on site, using the sludge and dewatering equipment available.

50.3.3.2 Composition and surface charges

Polymers are made up of long chains of special chemical elements, soluble in water, produced through consecutive reactions of polymerisation. They may be synthesised from individual monomers, which make up a sub-unit or a repeated unit within the molecular structure. They may also be produced through the addition of monomers or functional groups to natural polymers. Acrylamide is the most popular monomer used to produce organic synthetic polymer.

Regarding the surface charges, the polymers may be classified into *neutral* or *non-ionic*, *cationic* and *anionic*. Anionic flocculants with polyacrylamides introduce negative charges into the aqueous solutions, whereas cationic polyacrylamides carry positive charges. As most sludges have predominantly negative electric charges, polymers used for sludge conditioning are usually cationic. Sludge

Table 50.4. Main cationic polymers presented in dry powder (polyacrylamide copolymers)

Relative density (cationic) ¹	Molecular weight ²	Approximate dosage (kg/mt) ³
Low	Very high	0.25–5.00
Intermediate	High	1.00–5.00
High	Moderately high	1.00–5.00

¹ Low < 10 mole %; intermediate = 10–25 mole %; high > 25 mole %

² Very high = 4,000,000–8,000,000; high = 1,000,000–4,000,000; moderately high = 500,000–1,000,000

³ mt = metric ton = 1,000 kg

Source: EPA (1987)

characteristics and dewatering equipment will determine what cationic polymer shall be more productive and cost-effective. For instance, a higher level of electric charges is needed when sludge particles are very fine, water content is high and relative surface charges are increased.

Polymers are found in powder or liquid form. Liquid polymers may be commercialised as aqueous solutions or water-in-oil emulsions. Polymers must be protected from wide temperature changes during storage, which may vary from one to several years for dry polymer powders, whereas most liquid products have storage periods from 6 to 12 months. Polymers may be found in different molecular weights and charge densities, which might greatly affect their performance in sludge conditioning.

50.3.3.3 Dry polymers

Table 50.4 shows some characteristics of dry polymers. There is a great variety of available types of polymers and a number of chemical differences influencing their performance, which are not shown in Table 50.4.

Dry polymers are available as granular powder or flocs, depending upon the manufacturing process. Due to the large quantities of chemical polymeric products, dry polymers are very active, with the concentration of active solids reaching up to 90%–95%. Dry polymers need to be stored in dry fresh places, otherwise they tend to lump and become useless.

Dry polymers require special care to be dissolved. A typical polymer feeding system is shown in Figure 50.3.

The system must include an ejector or any other kind of polymer moistening device to pre-humidify the powder being fed, which must be slowly mixed inside the tank up to complete dissolution. An extra mixing period of about 60 seconds shall be provided to ensure complete polymer dissolution. Non-dissolved polymers might cause several problems, for instance, pump and pipe clogging, scaling in filter-presses and belt-presses. The mixing period also provides time for the polymer to become effective. During this action, polymer molecules are stretched and take up

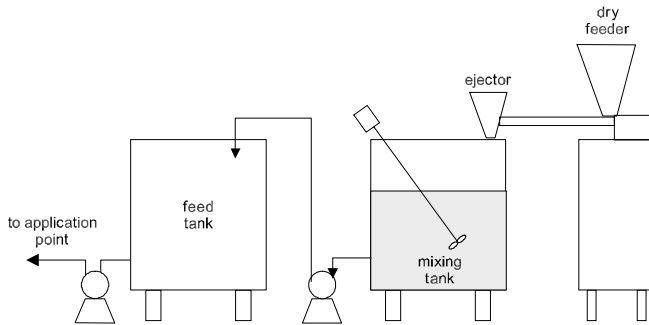

Figure 50.3. Dry polymer feeding system (EPA, 1987)

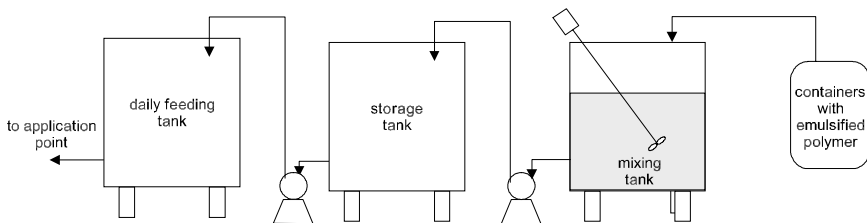

Figure 50.4. Liquid polymer feeding system (EPA, 1987)

a shape that favours sludge flocculation. If enough time is not provided, polymeric solution performance is affected.

50.3.3.4 Liquid polymers

Liquid polymers are traded with different concentrations and types of polymeric materials. They are also the active product of sludge conditioning and their dissolution depends upon the viscosity of the final solution. Stirring of concentrated polymeric solutions is not necessary, since polymers are able to form true solutions.

Liquid polymer solutions are available in 208 L containers, 1,040 L vessels, or in bulk depending on demand. Caution must be taken regarding storage in cold climates, as change in density may render its pumping impracticable.

The preparation of the dosing solution is constituted of a mixing tank and a storage tank for the diluted polymer (Figure 50.4). Normally, a 0.1% polymer solution is produced by mixing a concentrated polymer solution and water for at least 30 minutes. This solution remains stable for up to 24 hours and should be wasted after this period.

Table 50.5. Typical doses of dry polymers in different dewatering processes for several sludge types

Type of sludge	Belt press (kg/mt)		Centrifuges (kg/mt)	
	Range	Typical	Range	Typical
<i>Raw</i>				
– Primary	1–5	3	1–4	2
– Primary + TF	1–8	5		
– Primary + AS	1–10	4	2–8	4
– AS	1–10	5		
<i>Anaerobic digestion</i>				
– Primary	1–5	2	3–5	3
– Primary + AS	1–8	3	3–8	4
<i>Aerobic digestion</i>				
– Primary + AS	2–8	5		
<i>Thermal conditioning</i>				
– Primary + TF			1–3	2
– Primary + AS			3–8	4

AS = activated sludge; TF = Trickling filter sludge; mt = metric ton = 1,000 kg.

Source: Adapted from EPA (1987)

50.3.3.5 Typical polymer dosages

Table 50.5 shows usual polymers dosages for some mechanical dewatering processes, for various sludge types.

Example 50.2

Estimate the amount of polymer needed for conditioning the sludge from a 100,000 inhabitants conventional activated sludge treatment plant (Example 47.2). The mixed sludge undergoes anaerobic digestion before continuous centrifugation dewatering.

Solution:

(a) Amount of sludge

From Example 47.2, digested mixed sludge is: 100,000 inhabitants \times 50 gTS/inhabitant \cdot d = 5,000,000 gTS/d = 5,000 kgTS/d = 5 mt TS/day.

(b) Daily polymer consumption

From Table 50.5, the dosage should be 3–8 kg/mt. Adopting 5 kg of dry polymer/mt of TS in the sludge, the daily polymer consumption will be:

$$\begin{aligned} M_{\text{pol}} &= 5 \text{ (mt TS/d)} \times 5 \text{ (kg dry polymer/mt TS in the sludge)} \\ &= 25 \text{ kg of polymer/day} \end{aligned}$$

This value will be used for sizing the polymeric solution system and the feeding of the dewatering system.

50.3.4 Inorganic chemical conditioning

50.3.4.1 Main products

Inorganic chemical conditioning is mainly used for vacuum or pressure filtration dewatering. Mostly used chemicals are lime and ferric chloride. Although less frequently, ferrous chloride, ferrous sulphate and aluminium sulphate are also employed.

50.3.4.2 Ferric chloride

Ferric chloride is usually associated with lime for sludge conditioning, lime being added afterwards. Ferric chloride is hydrolysed in water and forms positively charged iron complexes that neutralise the negative surface charges in the sludge solids, allowing their aggregation. Ferric chloride also reacts with the sludge bicarbonate alkalinity, forming hydroxides that act as flocculants, according to the following reaction:



Ferric chloride solutions are usually employed in 30%–40% concentrations, as received from the supplier. Its dilution is not recommended as this may promote hydrolysis and precipitation of ferric hydroxide. Solutions can be stored for a long time without deterioration, although crystallisation may occur under low temperatures (below -1°C , a 45% FeCl_3 solution crystallises). Ferric chloride is a very corrosive product, requiring special pumps, resistant storage materials and careful operational procedures.

50.3.4.3 Lime

Slaked lime is usually utilised together with ferric chloride mainly for pH and odour control, as well as pathogen reduction. The resulting product of the reaction of lime with bicarbonate (CaCO_3) yields a granular structure in the sludge, increasing its porosity and reducing its compressibility.

Lime is traded as quicklime (CaO) or as slaked lime [$\text{Ca}(\text{OH})_2$]. Before use, quicklime must be slaked with water, producing $\text{Ca}(\text{OH})_2$. The slaking operation releases considerable heat, demanding proper equipment and care to protect plant workers. When selecting the slaking process, the CaO contents in the different types of quicklime must be taken under consideration (Table 50.6). Slaked lime

Table 50.6. CaO contents in different types of quicklime

Rating	CaO content (% of mass)
Low content	50–75
Intermediate content	75–88
High content	88–96

Table 50.7. Dosages of conditioners for filter presses dewatering

Type of sludge	Filter press (kg/mt)	
	FeCl ₃	CaO
<i>Raw</i>		
– Primary	40–60	10–140
– Activated sludge (AS)	70–100	200–250
<i>Anaerobically digested</i>		
– Primary + AS	40–100	110–300
<i>Thermally conditioned</i>	Nil	Nil

Source: Adapted from EPA (1987), WEF (1996)

must be stored in dry places to prevent hydration reactions with air moisture, which would render it useless.

On the other hand, slaked lime requires no slaking, mixes easily with water, releasing negligible heat and does not demand special storage requirements. However, because slaked lime is more expensive and less available than quick lime, slaking of quicklime on site may be more economical in plants consuming more than 1–2 mt of lime per day.

50.3.4.4 Applied dosages

Chemical conditioning increases approximately one metric ton of sludge mass for every metric ton of lime or ferric chloride used. Chemical conditioning using lime stabilises the sludge, but reduces its heating value for incineration. Dosing ranges for filter presses and different types of sludges are presented in Table 50.7.

Example 50.3

Estimate the amount of chemicals needed for conditioning the sludge from a 100,000 inhabitants conventional activated sludge treatment plant (Example 47.2). The mixed sludge undergoes anaerobic digestion before filter press dewatering in continuous operation.

Solution:

(a) Amount of sludge

From Example 47.2, the production of digested mixed sludge is: 100,000 inhabitants \times 50 gTS/inhabitant.d = 5,000,000 gTS/d = 5,000 kgTS/d

(b) Maximum quantity of FeCl₃ needed per day

The required quantity must be calculated incorporating a good safety margin, adopting the upper range from Table 50.7 for anaerobically digested mixed sludge. Assuming 100 kg of FeCl₃ per mt of TS:

Example 50.3 (Continued)

$$M_{\text{FeCl}_3} = 5,000 \text{ (kgTS/d)} \times 100 \text{ (kg FeCl}_3\text{/1,000 kg TS)}$$

$$= 500 \text{ kg FeCl}_3\text{/day}$$

(c) Volume of the solution with 40% FeCl₃

The solution of 40% FeCl₃ has 1.0 kg of FeCl₃ per 1.77 L of solution. Therefore:

$$V_{\text{FeCl}_3} = 500 \text{ (kg FeCl}_3\text{/day)} \times 1.77 \text{ (L/kg FeCl}_3\text{)} = 885 \text{ litres of solution/day}$$

(d) Quantity of CaO needed

Using 300 kg of CaO per mt of TS (upper limit of Table 50.7), the required amount is:

$$M_{\text{CaO}} = 5,000 \text{ (kgTS/d)} \times 300 \text{ (kg CaO/1,000 kg TS)}$$

$$= 1,500 \text{ kg CaO/day}$$

(e) Quantity of quicklime needed

Using a quicklime with 90% CaO in its composition, the daily amount is:

$$M_{\text{quicklime}} = 1,500 \text{ (kg CaO/day)} \times (1/0.9) \text{ (kg quicklime / kg CaO)}$$

$$= 1,667 \text{ kg quicklime/day}$$

(f) Extra daily solids production due to conditioning

It is estimated that the extra production will be 1.0 kg TS/kg (FeCl₃ + lime) added.

$$M_{\text{extra sludge}} = 1.0 \times [500 \text{ kg (FeCl}_3\text{/day)} + 1,667 \text{ (kg quicklime/day)}]$$

$$= 2,167 \text{ kg TS/day}$$

(g) Total mass of dry solids produced daily in the treatment plant

$$M_{\text{dry sludge}} = 5,000 \text{ (kgTS/d)} + 2,167 \text{ (kg TS extra sludge/day)}$$

$$= 7,167 \text{ kg TS/day}$$

(h) Mass of sludge (wet basis) produced daily after dewatering (sludge cake at 30% TS)

$$M_{\text{sludge cake}} = 7,167 \text{ (kg TS/day)} \times (100\%/30\%) = 23890 \text{ kg sludge/day}$$

Table 50.8. Main factors influencing dewatering efficiency in mechanical processes

Factors influencing dewatering	Causes
Proportions of primary and secondary sludge in the sludge to be dewatered	Secondary sludge retains twice the amount of water held by primary sludge (in kg of water/kg TS) during dewatering
Type of secondary sludge	The longer the sludge age, the larger the amount of water kept in the sludge. Bulked sludges (with excessive filamentous organisms) retain more liquid than non-bulked ones
Sludge conditioning	The use of chemicals for sludge conditioning may substantially improve the performance of the dewatering process
Type and age of the dewatering equipment	A number of variants of the same dewatering equipment may present different efficiencies. Older equipment is usually less efficient than modern ones
Design and operation	The design and operation of the dewatering units directly influences the cake TS contents. Equipment running near their limiting capacity tend to produce wetter cakes (3% to 5% less TS). Dryer cakes are obtained with lower loading rates
Industrial discharges	Industrial discharges into the sewerage system may positively or negatively affect the performance of the dewatering stage

50.4 OVERVIEW ON THE PERFORMANCE OF THE DEWATERING PROCESSES

Table 50.8 shows important factors influencing the solids concentration in sludge cake following mechanical processes.

Table 50.9 compares the dewatering efficiencies for natural and mechanical (with conditioning) dewatering processes. However, it should be noticed that the figures presented may vary from plant to plant.

The best results for mechanical dewatering are obtained using filter presses (plate or diaphragm). This is a discontinuous process, that may produce cakes 6%–10% dryer than continuous processes. With the inclusion of the diaphragm, this difference may reach 9%–15% more TS. Ferric chloride and lime are usually the preferred inorganic conditioning agents applied in filter press and vacuum filter dewatering. Both types of dewatering equipment become slightly less efficient (2%–5% wetter sludges) if organic instead of inorganic polymers are used.

Centrifuges and belt presses come next in terms of dewatering efficiency, with similar results for different types of sludge. Belt presses with a wider range of pressure adjustment capability may produce 2%–3% dryer cakes than centrifuges.

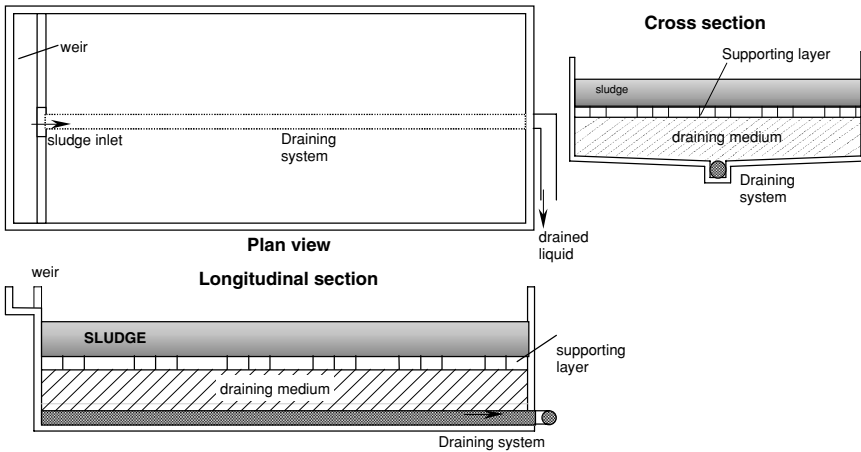

Figure 50.5. Diagram of a sludge drying bed (Gonçalves, 1999)

50.5 SLUDGE DRYING BEDS

50.5.1 Main characteristics

An introductory description and critical analysis of sludge dewatering by drying beds was presented in Section 5.7.a. Water is removed by evaporation and percolation. The process consists of a tank, usually rectangular, of masonry or concrete walls and a concrete floor. Inside the tank the following elements enable the drainage of the sludge water (Figure 50.5):

- draining medium
- supporting layer
- draining system

Draining medium. Allows percolation of the liquid present in the sludge through top layers of sand and bottom layers of gravel. The layers are placed so that the grain sizes rank from top to bottom in increasing diameter, ranging from 0.3 mm in the upper part (sand) to 76 mm in the lower part (gravel) (Figure 50.6). The total depth of the layers is approximately 0.50 m.

Supporting layer. The supporting layer is built with hard burnt brick or other material able to withstand the dry-sludge removal operation. The elements are usually arranged as shown in Figure 50.7 with 20–30 mm joints with coarse-grained sand. The supporting layer allows a better distribution of the sludge, avoids clogging of the draining medium pores and ensures the dewatered sludge removal without disturbance of the draining medium layers.

Drainage system. It is made up of 100 mm pipes laid out over the tank floor, with open or perforated joints aiming to drain all the liquid percolated through the

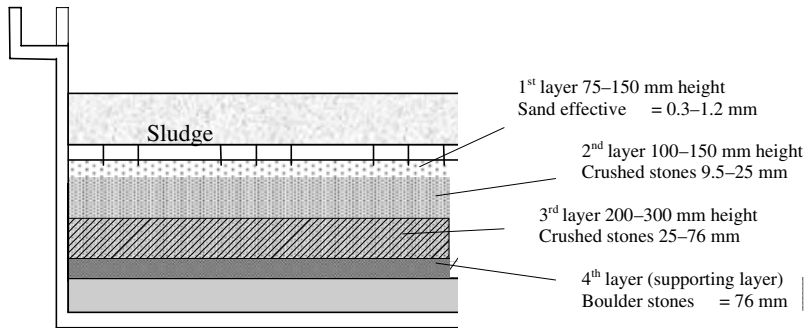

Figure 50.6. Details of the draining medium (Gonçalves, 1999)

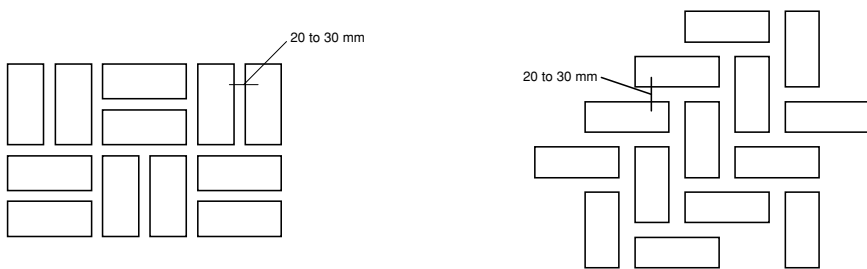

Figure 50.7. Detail of the bricks arrangement in the supporting layer (Gonçalves, 1999)

draining medium layers. The distance between the pipe drains shall not surpass 3 m. The floor of the drying bed must be even and impermeable, with minimum 1% slope towards the main draining collector.

50.5.2 General aspects of sludge dewatering in drying beds

When well digested (small fraction of biodegradable solids content), sludge subjected to natural drying has satisfactory characteristics, allowing dewatering within a short period of time (Jordão and Pessôa, 1995). An example is the bottom sludge from stabilisation ponds, which presents these characteristics and usually has reached sufficient biological stability to allow a liquid–solid separation with no need of prior treatment.

Sludge drying beds may be open-air constructions or covered for protection against rainfall. Drying is undertaken as a batch process, sequentially routing the sludge to several drying beds (van Haandel and Lettinga, 1994). According to Hess (1973), digested sludges submitted to high hydraulic pressures, either in clarifiers or in sludge digesters, may present interstitial water saturated with gases

such as CO₂ or methane. This sludge may float in drying beds due to density differences between digested sludge and water. During most of the dewatering period, the water percolates easily through the draining bed, up to the moment when the sludge deposits itself and changes into a thick pasty mass. From this point on, the percolation virtually ends and drying is achieved through natural evaporation.

According to Imhoff (1966), the level of sludge stabilisation may be derived from the final characteristics of the dewatered sludge, as described below:

- dry sludge with scarce and thin cracking: indication of a well-digested sludge with a low water content
- large number of medium-sized cracks: indication of a digested sludge with high water content
- small quantities of wide cracks: indication of a poorly-digested sticky sludge, requiring long drying periods

Besides the sludge physical characteristics, climatic conditions also influence the performance of this type of process. Natural drying may promote a considerable removal of pathogenic organisms due to sunlight exposure (van Haandel and Lettinga, 1994).

When the solids content reaches around 30%, the sludge is ready to be withdrawn from the drying bed, to avoid difficulties associated with later removal. Prolonged stay of dry sludge in the drying beds leads to the growth of vegetation, indicating a poor plant management.

50.5.3 Design of drying beds

(a) Design based on loading rates

Sizing of drying beds may use empirical rates, either derived from experience on similar applications, or obtained through tests carried out under controlled conditions, specific to the focused situation. The main variables are:

- sludge production at the treatment plant
- sludge characteristics concerning total solids and volatile solids contents
- cake total solids content, which will determine the drying period
- sludge layer height on the drying bed

Brazilian standards (ABNT, 1989) recommendations are summarised as follows:

- solids loading rate: $SLR \leq 15 \text{ kg TS/m}^2$ of bed surface per drying cycle
- at least two drying beds should be provided
- maximum transportation distance for the removal of dried sludge within each bed: 10 m

Example 50.4 illustrates the design of sludge drying beds based on solids loading rates.

(b) Design based on the concept of productivity

Another design possibility is proposed by van Haandel and Lettinga (1994), as illustrated in Example 50.5, based upon field data and using the concept of productivity.

Example 50.4

Design a drying bed system for a 100,000 inhabitants treatment plant with UASB reactors (Example 47.1), using loading rates criteria. The drying period has been estimated to be 15 days, based upon existing drying beds performance. The dry sludge shall be removed after 5 days.

Solution:

(a) Amount of sludge to be dewatered

According to Tables 47.1 and 47.2, the per capita sludge production is 12–18 gSS/inhabitants·d, and the per capita volumetric production is 0.2–0.6 L/inhabitant·d for sludges from UASB reactors. Assuming intermediate values, the total sludge production for the 100,000 inhabitants may be computed as follows:

$$\begin{aligned} \text{SS load in the sludge: } M_s &= 100,000 \text{ inhabitants} \times 15 \text{ g/inhabitants}\cdot\text{d} \\ &= 1,500,000 \text{ gSS/d} = 1,500 \text{ kgSS/d} \end{aligned}$$

$$\begin{aligned} \text{Sludge flow: } Q_s &= 100,000 \text{ inhabitants} \times 0.4 \text{ L/inhabitant}\cdot\text{d} \\ &= 40,000 \text{ L/d} = 40 \text{ m}^3/\text{d} \end{aligned}$$

These values are equal to those computed in Example 47.1.

(b) Operational cycle time of the drying bed

$$T = T_d + T_c$$

where:

T_d = drying time (days)

T_c = cleaning time (days)

$$T = 15 + 5 = \mathbf{20 \text{ days}}$$

(a) Volume of dewatered sludge per cycle

$$V_s = Q_s \times T$$

Example 50.4 (Continued)

where:

V_s = volume of dewatered sludge per cycle (m^3)

Q_s = sludge flow (m^3/day)

$$V_s = 40 (m^3/d) \times 20 (d) = 800 m^3/cycle$$

(b) Area required for the drying bed

$$A = (M_s \cdot T) / SLR = [1,500 (kg TS/d) \times 20 (d)] / 15 (kg TS/m^2) = \mathbf{2,200 m^2}$$

where:

A = drying bed area (m^2)

SLR = nominal solids loading rate (adopted as **15 kg TS/ m^2**)

The per capita required area is:

$$\text{Per capita area} = 2,200 m^2 / 100,000 \text{ inhabitants} = 0.022 m^2/\text{inhabitant}$$

(c) **Dimensions of the drying cells**

A total of **22 cells** (greater than the cycle time of 20 days) with $100 m^2$ each will be used. Each cell will be **10 m wide** and **10 m long**.

(d) **Height of the sludge layer after loading operation at the drying bed**

The sludge is calculated by:

$$H_s = V_s / A = 800 (m^3/cycle) / 2,200 (m^2/cycle) = \mathbf{0.36 m}$$

Example 50.5

An anaerobic pond treating sewage from 20,000 inhabitants has accumulated $723 m^3$ of sludge after 2 years of uninterrupted operation. The removal of 80% of the accumulated sludge volume shall be accomplished, and subsequent dewatering in drying beds within the plant area is being planned. Compute the required area for the drying beds using the concept of productivity, assuming sludge is removed with 92% moisture (water) content (8% TS), and should be dewatered to reach a moisture content of 73% (27% TS).

Solution:

(a) **Solids mass to be removed**

$$M_{\text{sludge}} = V_{\text{sludge}} \times SC_i \times \rho_s$$

Example 50.5 (Continued)

where:

$$V_{\text{sludge}} = \text{volume of sludge to be removed} = 723 \text{ m}^3 \times 0.8 = 579 \text{ m}^3$$

$$SC_i = \text{initial sludge solids content} = 8\% \text{ (moisture} = 92\%)$$

$$\rho_s = \text{sludge density} = 1,020 \text{ kg/m}^3$$

$$M_{\text{sludge}} = 579 \times 0.08 \times 1,020 = 47 \times 10^3 \text{ kgTS}$$

(b) Productivity

The productivity relates the applied solids load (kgTS/m^2) and the drying period (days) for a particular moisture (water content). As shown in Figure 50.8, this is the ratio of TS mass per unit area and per unit time. The curves shown in Figure 50.8 are derived from actual field data from one specific anaerobic pond in Southeast Brazil (Gonçalves, 1999).

For sludges from UASB reactors with a final water content of 70% (30% TS), productivity values of $1.65 \text{ kgTS/m}^2 \cdot \text{d}$ were gathered in a warm region (Northeast Brazil) and $0.55 \text{ kgTS/m}^2 \cdot \text{d}$ in a milder climate (Southeast Brazil) (Aisse *et al.*, 1999).

The solids loading to be applied is a function of the desired operating conditions of the drying bed, that is, sludge cake final moisture, sludge drying cycle and height of the sludge layer. The Brazilian standards previously mentioned (NB-570, ABNT, 1989) recommend a 15 kgTS/m^2 loading rate. Nevertheless, experimental results with higher rates using sludges from ponds were obtained and considered satisfactory.

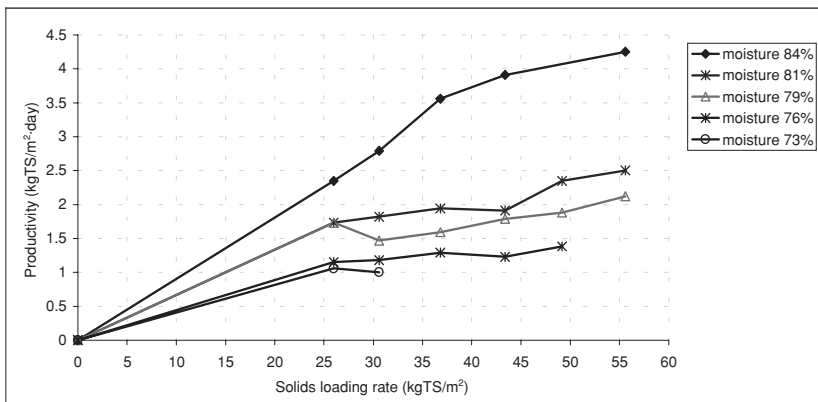

Figure 50.8. Productivity of sludge drying beds as a function of the applied solids loading (for a particular anaerobic pond sludge)

Example 50.5 (Continued)

Considering in this example a solids loading rate SLR_{sludge} of 30 kgTS/m^2 and a 73% cake final moisture, the productivity is derived from Figure 50.8 as:

$$P = 1.0 \text{ kgTS/m}^2 \cdot \text{d}$$

(c) Determination of the drying cycle

The time needed to promote dewatering (drying cycle) depends on the applied solids loading and the expected bed productivity.

$$T = SLR_{\text{sludge}}/P$$

$$T = 30 \text{ (kgTS/m}^2\text{)}/1.0 \text{ (kgTS/m}^2\text{·d)} = \mathbf{30 \text{ days}}$$

(d) Required drying bed area

$$A = M_{\text{sludge}}/(P \times T)$$

where:

A = total area of the drying beds (m^2)

M_{sludge} = sludge mass (kgTS)

P = drying bed productivity ($\text{kgTS/m}^2 \cdot \text{d}$)

T = drying cycle (days)

$$A = 47 \times 10^3 \text{ (kgTS)}/(1.0 \text{ kgTS/m}^2 \cdot \text{d} \times 30 \text{ d}) = \mathbf{1,567 \text{ m}^2}$$

The per capita required area is:

$$\text{Per capita area} = 1,567 \text{ m}^2/20,000 \text{ inhabitants} = 0.078 \text{ m}^2/\text{inhabitant}$$

For the conditions of the present example, the sludge height to be applied on the drying beds is:

$$H_{\text{sludge}} = V_{\text{sludge}}/A$$

$$H_{\text{sludge}} = 579 \text{ m}^3/1,567 \text{ m}^2 = \mathbf{0.37 \text{ m}}$$

The drying bed area could be split according to the following alternatives (among others):

- 3 beds with $15 \text{ m} \times 30 \text{ m}$
- 5 beds with $12 \text{ m} \times 30 \text{ m}$
- 6 beds with $10 \text{ m} \times 30 \text{ m}$
- 7 beds with $10 \text{ m} \times 25 \text{ m}$

(e) Stagewise removal of the sludge from the pond

Since this sludge is removed from a stabilisation pond, it may remain on the drying beds for long periods, reaching even lower water contents, considering the usual large time intervals between successive sludge removal operations.

Example 50.5 (Continued)

In case the selected sludge removal technique allows withdrawals in two different stages, a feasible alternative to reduce the area requirements would be to remove and dry part of the sludge and, after the drying cycle, remove and dry the remainder of the sludge. In the above example, if half of the sludge is removed from the pond, the area would also be reduced by half.

(f) Influence of rainfall

The effect of rainfall on the removal of the sludge water was not taken into account when analysing the productivity presented in Figure 50.8. To consider rainfall, an estimate is needed about the average water removal rate from the drying bed. If P is the productivity of the bed and w_i and w_f represent the initial and final sludge moisture, respectively, the average water removal rate could be defined as:

$$T_w = Tw_i - Tw_f$$

where:

$$Tw_i = \text{water loading rate} = P \times w_i / (1 - w_i)$$

$$Tw_f = \text{water withdrawal rate} = P \times w_f / (1 - w_f)$$

Hence:

$$T_w = P \{ [w_i / (1 - w_i)] - [w_f / (1 - w_f)] \}$$

$$T_w = 1.0 \{ [0.92 / (1 - 0.92)] - [0.73 / (1 - 0.73)] \}$$

$$T_w = 8.80 \text{ l/m}^2 \cdot \text{day} = 8.80 \text{ mm/day} = 3,212 \text{ mm/year}$$

Assuming 1,254 mm/year of rainfall in this period, the ratio of the water removal rate over the accumulated precipitation during the year is approximately 2.6 ($= 3,212 / 1,254$). The area of the drying bed should therefore be increased by 1/2.6 (38%) if rainfall is to be considered. The corresponding productivity shall also be reduced in 38%. Thus, the final area of the drying bed will become $A = 1,567 \text{ m}^2 \times 1.38 = 2,163 \text{ m}^2$.

50.5.4 Operational aspects

The solutions for operational problems in sludge drying beds are simple, as a consequence of their inherent conceptual simplicity. Table 50.10 presents some operational measures for the solution of drying bed problems.

50.6 CENTRIFUGES**50.6.1 General description of the process**

An introductory description and critical analysis of sludge dewatering by centrifuges was presented in Section 5.7.c. Centrifugation is a process of forced

Table 50.10. Main problems and solutions in the operation of sludge drying bed

Detected problem	Possible cause of the problem	Check, monitor, control	Solution
Lengthy dewatering cycle	Excessive sludge height applied to the drying beds	Recommended sludge height should be lower than 20–30 cm for satisfactory results	Remove dried sludge and thoroughly clean the drying bed. Apply a thin layer of sludge and measure its height reduction after 3 days. Apply the double of the verified height reduction in the third day after the first application
	Sludge application after improper cleaning of the drying bed	Check the cleaning condition (maintenance) of the drying beds	Remove the sludge after drying. Thoroughly clean the bed surface and replace the top sand layer with 12–25 mm of clean sand, if necessary
	Clogged drainage system, or broken piping		Make a slow countercurrent cleaning through the drying bed, connecting a clean water source into the bottom draining pipe. Check and replace filter media, if necessary. Completely drain the top layer to keep freezing from happening in cold seasons
	Undersized bed area	Try improve filtering with polymers	Typical polymer dosage is 2.3–13.6 g cationic polymer/kg dry solids. Significant dewatering rates improvement may result
	Climatic conditions of the region	Temperature, rainfall	Protect bed against adverse weather
Sludge feeding pipe clogged	Deposits of solids or sand in piping		Fully open the valves in the beginning of the sludge application for pipe cleaning. Apply water jets, if necessary
Very thin sludge being withdrawn from the digester tank	Separation problems in the digester, with excessive supernatant removal		Reduce sludge withdrawal rate from the digester
Flies on top of the sludge layer			Crack the sludge top-crust layer and pour a calcium borate larvicide or similar. Exterminate adult flies with insecticide
Foul odour when sludge is applied	Inadequate sludge digestion	Operation and digestion process	Adjust the operation of the digestion process
Lumps and dust with dewatered sludge	Excessive dewatering	Check water content	Remove sludge from bed when 40% to 60% water content is obtained

Source: WEF (1996)

solid/liquid separation by centrifugal force. In the first stage known as clarification, sludge solids particles settle at a much higher speed than they would simply by gravity. In the second stage, compaction occurs, and the sludge loses part of its capillary water under the prolonged action of centrifugation. The cake is removed from the process after this latter stage.

As in sludge thickening, centrifugation is a sedimentation process originating from the difference of density between a particle and the surrounding liquid. The process may be described by Stokes equation, which expresses the settling velocity of a solid particle in a fluid (see Chapter 10):

$$V = [g \cdot (\rho_S - \rho_L) \cdot d^2] / (1,800 \cdot \mu) \quad (50.2)$$

where:

V = settling velocity of the solid particle in the liquid (m/s)

g = gravitational constant (m/s^2)

ρ_S = particle density (kg/m^3)

ρ_L = liquid density (kg/m^3)

d = average particle diameter (m)

μ = liquid viscosity ($kg/m \cdot s$)

The equation above shows that the settling velocity of a particle is directly proportional to the difference between the particle and the liquid densities and to the square of the particle diameter, and inversely related to the liquid viscosity.

The acceleration resulting from centrifugation (G) is usually related to the gravitational constant, as a multiple of g ($g = 9.81 m/s^2$). The centrifugal acceleration over a particle in a liquid inside a cylinder is given by:

$$G = \omega^2 \cdot R = (2\pi N/60)^2 \cdot R \quad (50.3)$$

where:

G = centrifugal acceleration of the particle (m/s^2)

ω = angular velocity (rad/s)

R = radius (m)

N = rotation speed (revolutions/min)

The settling velocity V of a solid particle in a centrifuge with radius R is obtained replacing g in Equation 50.2 by G defined in Equation 50.3.

A sludge dewatering centrifuge works with a centrifugal acceleration 500–3,000 higher than the gravitational constant, and the settling velocity of 10 m/hour is 50 times greater than the natural thickening velocities for sludges. The magnitude of the forces involved makes the inner bond forces among particles to split. This allows a better separation than would be possible through a simple static settling.

50.6.2 Types of centrifuges

Centrifuges may be used indistinctly for sludge thickening and dewatering. The operating principle remains the same, with the possibility of installing centrifuges in series, with thickening being accomplished in the first stage and dewatering in the following one. Equipment capacities vary, but a range from 2.5 m³/hour to 180 m³/hour of incoming sludge flow is usually available.

Vertical and horizontal shaft centrifuges are used in sludge dewatering. They differ mainly in the type of sludge feeding, intensity of the centrifugal force applied and manner of discharging the cake and the liquid from the equipment. Horizontal shaft centrifuges are most widely applied for thickening and dewatering of sludges. A relatively lower cake solids contents and the need to feed semi-continuously are among the reasons why vertical shaft centrifuges are less used. The advantages and disadvantages of horizontal-shaft centrifuges are presented in Section 5.7.c.

Horizontal centrifuges in use today are of solid-bowl type, with moving parts consisting of the rotating bowl and the rotating conveyor/scroll, made of stainless steel or carbon steel. The main components of a centrifuge are: support basis, bowl, conveyor scroll, cover, differential speed gear, main drive and feeding pipe.

The support basis, normally built of steel or cast iron, has vibration insulators for reducing vibration transmission. The cover, which involves all moving parts, helps to reduce odours and noise and collects both the centrifuged liquid (centrate) and the dewatered sludge. The bowl has a cone-cylinder shape, with variable characteristics depending upon the manufacturer. The bowl length:diameter ratio varies from 2.5:1 to 4:1, with diameters ranging from 230 to 1,800 mm. The differential speed gear allows the rotational speed differences between the bowl and the screw conveyor.

Both the bowl and the conveyor scroll rotate in the same direction at high speed, with the scroll speed slightly different from the bowl speed, allowing for a conveying effect to take place. The scroll is located inside the bowl core, keeping a 1–2 mm radial aperture, just enough for the passage of the centrifuged liquid. Velocities between 800–3200 rpm normally yield cakes containing solid levels greater than 20% and a clarified centrate. Higher centrifugation speeds imply lower polyelectrolyte consumption, higher solids capture and possibly higher cake solid content. This may come at the expense of higher maintenance costs due to bearings abrasion.

The centrifuge reduction gear-box produces rotational differences from 1 to 30 rpm between the bowl and the screw conveyor. Sludge feeding rate, the speed difference and the bowl rotational speed are the main parameters controlling the solids retention time inside a centrifuge. High solids cakes result from high retention time, low speed differential and compatible sludge feeding rate.

The sludge thickening achieved depends upon the sludge type and the initial solids concentration. In general, it can be said that dryer cakes are obtained when the speed difference between the bowl and the screw conveyor is kept to a minimum.

Horizontal centrifuges may be classified according to the direction of the feeding flow and the way the cake is withdrawn into *co-current* or *counter-current*. They

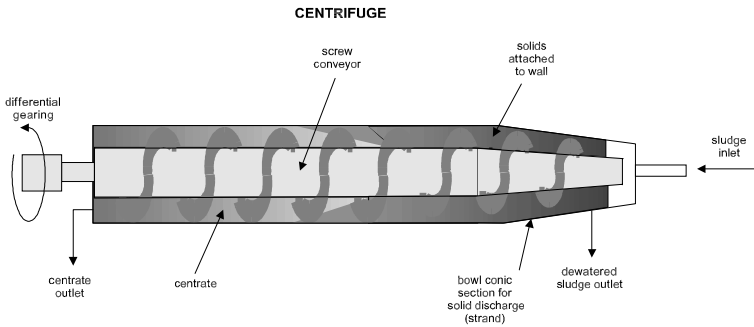

Figure 50.9. Diagram of a countercurrent horizontal centrifuge

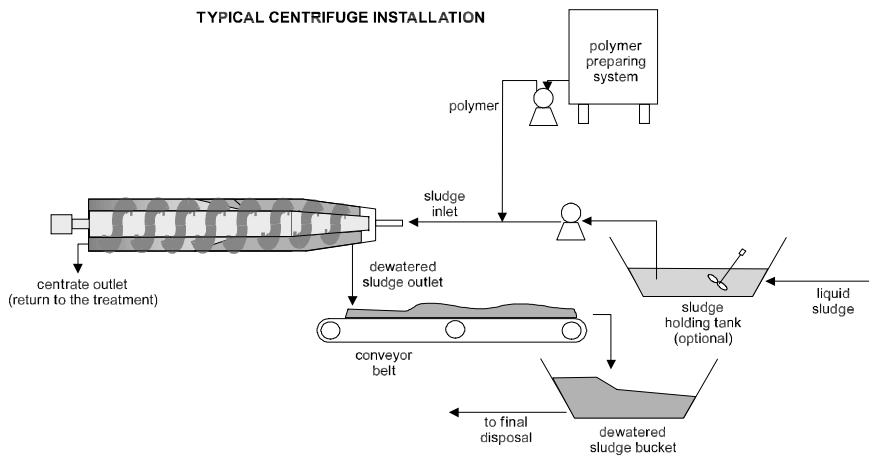

Figure 50.10. Typical installation of a decanter-type centrifuge

differ in the sludge feeding points, the way the centrate is removed (liquid phase) and the direction of the solid and liquid phases within the unit. In co-current centrifuges, the solid phase and the liquid phase cross all the way through the longitudinal axis of the centrifuge bowl until being discharged. In counter-current models, the sludge is fed on the opposite side from the centrate releasing point. The solid phase is routed out by the screw conveyor towards the end of the conic section, while the liquid phase makes the opposite path. Figure 50.9 shows a diagram of a counter-current centrifuge.

50.6.3 Dewatering flowsheet using centrifuge

Figure 50.10 illustrates the flowsheet of sludge dewatering by centrifuge. The area required for a large centrifuge having a sludge feeding capacity from 10 to 40 L/s is approximately 40 m² (WEF, 1996). This is one of the main advantages centrifuges

have over other mechanical sludge dewatering equipments. Centrifuges do not emit aerosol or excessive noise, and may be installed in open sheds. Electric power consumption and maintenance costs are fairly high, limiting their use for wastewater treatment plants with flows higher than 100 L/s, or where area availability is a limiting factor. Other components that must be taken into consideration in the design of the dewatering facility are:

- conditioning system, with polymer tanks, dosage equipments and piping
- sludge dosing pumps and piping
- access of vehicles for centrifuge maintenance
- areas for circulation, ventilation, electric equipments and smell control

Depending upon the centrifuge operating regime, liquid sludge may be kept in a sludge holding tank, equalising sludge flow prior to dewatering. A similar comment is equally valid regarding other mechanised dewatering processes.

In a fully mechanised system, dewatered sludge is conveyed through a conveyor belt towards a container or the storage area within the treatment plant where it will remain until transportation to final disposal. The conveyor belt mechanism should be set to switch on just before the centrifuge, and to switch off a few minutes after the centrifuge.

50.6.4 Performance

The characteristics influencing centrifugation performance are the same that influence sedimentation. The main variables influencing centrifuge performance are sludge solids concentration, type of conditioning, feed flow and temperature. Larger particles are easily captured by the centrifuge, while finer particles require conditioning to reach a sufficient size for capture.

The effectiveness of chemicals such as polyelectrolytes is more closely related with the solids concentration of the centrate (solids capture) than with the cake solids content. Cationic polyelectrolyte is often used as a flocculation aid, giving better solids capture and greater feed flow. Anionic polyelectrolytes are used along with metallic coagulants.

Another factor determining the centrifuge efficiency is the sludge volatile solids concentration. High sludge stabilisation levels improve centrifuge performance, allowing high cake solids content.

Several mechanical factors influence the equipment performance. The manufacturer, however, is responsible for most of the settings. Plant staff shall undertake the following adjustments:

- pool depth, normally set by the supplier after preliminary tests
- injection point of the metallic coagulants and polyelectrolyte
- feed flow
- bowl and conveyor scroll differential speed

Table 50.11. Typical centrifuge performance in sludge dewatering

Type of sludge	TS concentration in cake (%)	Solids capture (%)	Polyelectrolyte dosage (g/kg)
Primary raw sludge	28–34	95	2–3
Anaerobic sludge	35–40	95	2–3
Activated sludge	14–18	95	6–10
Raw mixed* sludge	28–32	95	6–10
Anaerobic mixed sludge	26–30	95	4–6
Aerobic sludge**	18–22	95	6–10

* primary sludge + excess activated sludge

** extended aeration or excess activated sludge

Table 50.12. Suggestions of capacities and number of centrifuges

Liquid sludge flow (m ³ /d)	Operating hours	Number of units		Capacity of each unit (m ³ /hour)
		In operation	Spare	
40	7	1	1	6
80	7	1	1	12
350	15	2	1	12
800	22	2	1	18
1,600	22	3	2	25
4,000	22	4	2	45

• Number of operating hours = Sludge flow (m³/d)/[(Number of operating units) × (Capacity of each unit, in m³/hour)]

• Refer to manufacturer's catalogue for different centrifuge capacities

Source: Adapted from EPA (1987)

Adjustment of a centrifuge may be done either aiming at a drier cake production or a better-quality centrate, as the operator requires. Emphasis on cake solids content increases centrate solids concentration (low capture of solids), and vice-versa. Table 50.11 shows typical performance data of horizontal axis centrifuges in sludge dewatering.

50.6.5 Design

The sizing of a centrifuge dewatering facility is based upon manufacturer data on the equipment loading capacity and the type of liquid sludge. Whenever possible, preliminary tests should be carried out. Manufacturers should always be consulted on design details and characteristics of the different models. Dimensions of the equipments (diameter and length) vary among suppliers, as well as performance data such as power, maximum bowl speed and maximum centrifugal force.

The number of operating and spare units is a function of plant capacity and sludge production, as well as maintenance staff size and availability of alternative sludge disposal routes. General guidelines to select the number of operating and spare units presented in Table 50.12, are based on EPA (1987). These values, however, may vary widely from one case to another.

The main information required for sizing is:

- type of sludge to be treated
- daily sludge flow
- dry solids concentration

Other useful data used for predicting the performance of a centrifuge are the SVI (Sludge Volume Index) and fixed and volatile solids content.

Example 50.6

For the wastewater treatment plant of Example 47.4 (conventional activated sludge plant, with anaerobic digestion of mixed sludge; population = 67,000 inhabitants), size the centrifuges for sludge dewatering. Effluent sludge from secondary digester (influent to the dewatering unit) is 46.9 m³/day.

Solution:

(a) Influent sludge flow

$$Q_{av} = 46.9 \text{ m}^3/\text{d} = 1.95 \text{ m}^3/\text{hour} = 1,950 \text{ L/hour}$$

Considering an hourly peak factor of 1.5, the maximum sludge flow to be dewatered is:

$$Q_{max} = 1.5 \times 1.95 \text{ m}^3/\text{hour} = 2.93 \text{ m}^3/\text{hour} = 2,930 \text{ L/hour}$$

(b) Equipment selection

The selection of the centrifuge can be done considering the maximum sludge flow to be dewatered. This information, together with other relevant data, shall be supplied to the manufacturer for the final selection.

For this particular example, and based on Table 50.12, a 6 m³/hour centrifuge is selected (an operating unit and a spare one).

(c) Operating hours

The following number of operating hours per day is computed for the average influent sludge flow:

$$\begin{aligned} \text{Operating time (hour/d)} &= \frac{\text{Average influent sludge flow (m}^3/\text{d)}}{\text{Number of units} \times \text{Unitary capacity (m}^3/\text{hour)}} \\ &= \frac{46.9 \text{ m}^3/\text{d}}{1 \times 6 \text{ m}^3/\text{hour}} = 8 \text{ hours/d} \end{aligned}$$

In case the production of sludge to be dewatered is continuous (24 hours/d), a sludge holding tank capable of storing the sludge during non-operating hours is necessary. The liquid sludge in the current example is being withdrawn from the secondary digesters, which already play the role of a sludge holding tank.

Table 50.13. Problems and solutions in centrifuge operations

Operational problem	Consequence	Solution
Inadequate material blades	Excessive abrasion	Replace with more resistant material
Rigid feeding pipes	Pipe cracks and nipple leaks	Replace with flexible pipes
Grit in the sludge	Excessive abrasion of the equipment	Either review operation or install grit chamber
Excessive vibrations	Destabilisation of electric and mechanical parts	Install adequate shock absorbers
Electric control panels in the same room	Corrosion and deterioration of controls	Move electric panels to different room

50.6.6 Operational aspects

Variables affecting centrifuge performance may be classified into three categories, similarly as with other mechanical dewatering equipment:

- sludge characteristics
- sludge conditioning (preparation)
- equipment mechanical setting

A troubleshooting guide is presented in Table 50.13 regarding centrifuge operation.

50.7 FILTER PRESS

50.7.1 General description of the process

Filter presses were developed aiming at industrial use and later underwent changes to make them suitable for wastewater sludge dewatering operations. They operate through batch feeding which demands skilled operators. The major quality of filter presses is their reliability. The main advantages of filter press are:

- cake with higher solids concentration than any other mechanical equipment
- high solids capture
- quality of the liquid effluent (filtrate)
- low chemical consumption for sludge conditioning

50.7.2 Working principle

The filter press operating cycle varies from 3–5 hours, and may be divided into three basic stages:

- *Filling.* Pumped sludge is admitted into empty gaps between consecutive filter plates. The filling period may reach 20 minutes, but usual time intervals are 5 to 10 minutes. The filling pump pressure is sufficient to immediately initiate the solid/liquid separation processes in filter cloths.

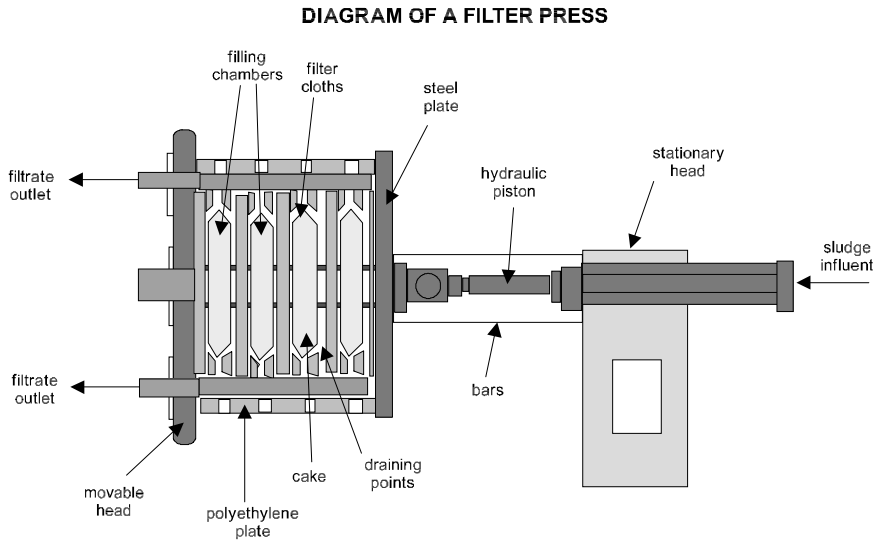

Figure 50.11. Operating diagram of a filter press

- *Filtration under maximum pressure.* During the filtration phase, the applied pressure may reach 170 kPa (17 atm –250 psi).
- *Cake discharge.*

The time for each batch varies according to sludge feeding pump flow, type of sludge, sludge solids content, influent sludge filterability and cleaning status of the filter cloth.

Figure 50.11 shows diagrammatically a cross section of a filter press. The liquid sludge is pumped into the recessed plates, enveloped by filter cloths. Pumping of the sludge increases the pressure in the space between plates, and the solids (filter cake) are left attached to the media as the liquid sludge passes through the filter cloth.

Afterwards, a hydraulic piston pushes the steel plate against the polyethylene plates, compressing the cake. Both the movable and the stationary head have support bars specifically designed for this purpose.

The filtrate passes through the filter cloths and is collected by draining points and filtrate channels. The filtrate usually has less than 15 mg SS/L. The cake is easily removed from the filter as the pneumatic piston moves back and the plates are separated from each other. After falling down from the plate, the compressed cake is ready to be routed to storage or final destination.

Figure 50.12 presents a typical filter press installation for sludge dewatering.

Nowadays, filter presses are automated, greatly reducing the need for hand labour. The weight of the equipment, its initial costs and the need for regular filter cloth replacement make the use of filter presses restricted to medium size and large wastewater treatment plants.

Table 50.14. Optimal performance of filter presses in sludge dewatering

Type of sludge	Solids content in cake (%)	Cycle (hours)
Primary	45	2.0
Primary + activated sludge	45	2.5
Activated sludge	45	2.5
Anaerobic primary	36	2.0
Anaerobic + activated	45	2.0

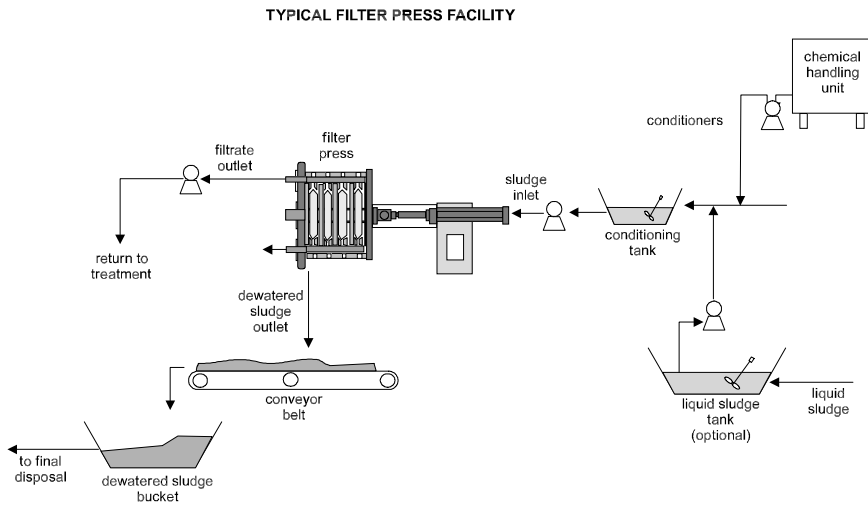

Figure 50.12. Flowsheet of a filter press facility for sludge dewatering

50.7.3 Performance

Table 50.14 presents optimal performance values for filter presses.

50.7.4 Design

The sequence of calculations for filter press sizing is illustrated in Example 50.7.

Example 50.7

For the wastewater treatment plant of Example 47.4 (conventional activated sludge, with anaerobic digestion of mixed sludge; population = 67,000 inhabitants), size a filter press system for sludge dewatering. The effluent sludge from the secondary digester (influent to dewatering) has a solids load of 1,932 kgTS/d (81 kg/hour) and a solids content of 4.0% TS (specific gravity = 1.03). The

Example 50.7 (Continued)

dewatering period shall be 5 days/week and 8 hours/day. TS content in cake must reach 40% TS. Estimated cake specific gravity is 1.16. Specific operating conditions are as follows:

- Cake thickness = 30 mm
- Filter press operating pressure = 15 bars
- Chemical conditioner: lime and ferric chloride
- Chemical dosing:
 - 10 to 20% CaO (average of 15%)
 - 7.5 % FeCl₃
- Chemical sludge formed:
 - Lime = 80% dosed CaO
 - FeCl₃ = 50% dosed FeCl₃
- Peak coefficient in sludge production = 1.25

Solution:*(a) Sludge production rate*

- Sludge mass (dry basis) = 1,932 (kgTS/d) × 7 (d/week) = 13,524 kgTS/week = 13.5 tonne TS/week
- Wet sludge volume = 13.5 (tonne/week) / (0.04 TS × 1.03) = 328 m³/week

(b) Daily and hourly demand for dry solids processing without chemicals

Based on a 5-day/week and 8-hour/day operating schedule, one has:

- Daily rate = 13.5 (tonne/week) ÷ 5 (d/week) = 2.7 tonne/day
- Hourly rate = 2.7 (tonne/d) ÷ 8 (hours/d) = 0.34 tonne/hour or 340 kg/hour

*(c) Daily cake volume considering chemicals added***(c1) Solids mass in cake (kg/d):**

$$\begin{aligned} \text{average} &= M_S = 1,932 \text{ kg/d} \\ \text{maximum} &= M_{S,\text{max}} = 1.25 \times 1,932 = 2,415 \text{ kg/d} \end{aligned}$$

(c2) Average dosage of FeCl₃ (kg/d)

$$\begin{aligned} M_{\text{FeCl}_3} &= 10^{-2} \times (\%_{\text{FeCl}_3}) \times M_S \\ \text{average} &= M_{\text{FeCl}_3} = 10^{-2} \times 7.5 \times 1,932 = 145 \text{ kg/d} \\ \text{maximum} &= M_{\text{FeCl}_3,\text{max}} = 10^{-2} \times 7.5 \times 2,415 = 181 \text{ kg/d} \end{aligned}$$

(c3) Chemical sludge mass FeCl₃ (kg/d)

$$\begin{aligned} M_{S,\text{FeCl}_3} &= (L_{\text{FeCl}_3} \cdot M_{\text{FeCl}_3}) \\ \text{average} &= M_{S,\text{FeCl}_3} = 0.5 \times 145 = 73 \text{ kg/d} \\ \text{maximum} &= M_{S,\text{FeCl}_3,\text{max}} = 0.5 \times 181 = 91 \text{ kg/d} \end{aligned}$$

Example 50.7 (Continued)

(c4) Average lime dosage

$$M_{\text{CaO}} = 10^{-2} \times (\%_{\text{CaO}}) \times M_S$$

$$\text{average} = M_{\text{CaO}} = 10^{-2} \times 15 \times 1,932 = 290 \text{ kg/d}$$

$$\text{maximum} = M_{\text{CaO,max}} = 10^{-2} \times 15 \times 2,415 = 362 \text{ kg/d}$$

(c5) Chemical sludge mass CaO (kg/d)

$$M_{\text{S,CaO}} = (L_{\text{CaO}} \cdot M_{\text{CaO}})$$

$$\text{average} = M_{\text{S,CaO}} = 0.8 \times 290 = 232 \text{ kg/d}$$

$$\text{maximum} = M_{\text{S,CaO,max}} = 0.8 \times 362 = 290 \text{ kg/d}$$

(c6) Total solids mass (kg/d)

$$M_s \text{ total} = M_S + M_{\text{FeCl}_3} + M_{\text{S,FeCl}_3} + M_{\text{CaO}} + M_{\text{S,CaO}}$$

$$\text{average} = M_s = 1,932 + 145 + 73 + 290 + 232 = 2,671 \text{ kg/d}$$

$$\text{maximum} = M_{s,\text{max}} = 2,415 + 181 + 91 + 362 + 290 = 3,339 \text{ kg/d}$$

(c7) Cake solids concentration

$$\text{average} = C_{\text{ST}} = 40\%$$

$$\text{maximum} = C_{\text{ST,max}} = 40\%$$

(c8) Cake specific gravity

$$\text{specific gravity} = 1.16$$

(c9) Cake volume (m³/d)

$$\text{average} = V_s = 2,671 \text{ (kgTS/d)} / (40\% \times 1.16) = 5,757 \text{ L/d} = 5.8 \text{ m}^3/\text{d}$$

$$\text{maximum} = V_{s,\text{max}} = 3,339 \text{ (kgTS/d)} / (40\% \times 1.16)$$

$$= 7,196 \text{ L/d} = 7.2 \text{ m}^3/\text{d}$$

(c10) Daily and hourly demand of dry solids processing with chemicals

Based on a 5-day/week and 8 hour/day operational schedule, one has:

- Average daily rate = $2,671 \text{ (kgTS/d)} \times 7 \text{ (d/week)} \div 5 \text{ (d/week)}$
 $= 3,739 \text{ kgTS/d} = 3.8 \text{ tonne/d}$
 $= 3,739 \text{ (kgTS/d)} / (40\% \times 1.16) = 8,060 \text{ L/d} = 8.1 \text{ m}^3/\text{d}$
- Maximum daily rate = $3,339 \text{ (kgTS/d)} \times 7 \text{ (d/week)} \div 5 \text{ (d/week)}$
 $= 4,675 \text{ kgTS/d} = 4.7 \text{ tonne/d}$
 $= 4,675 \text{ (kgTS/d)} / (40\% \times 1.16) = 10,075 \text{ L/d} = 10.1 \text{ m}^3/\text{d}$

Example 50.7 (Continued)*(d) Daily production of cakes*

(d1) Cake volume per filter-press plate

Adopting 1.0 m × 1.0 m plate size and 30 mm cake thickness, the cake volume per plate is:

$$V_p = 1.0 \times 1.0 \times 0.03 = 0.030 \text{ m}^3/\text{plate}$$

Assume for safety: $V_p = 0.025 \text{ m}^3/\text{plate}$

(d2) Daily cake production

The daily number of cakes is calculated by dividing the total daily cake volume by the cake volume of one plate (V_p):

$$\text{Average: } N_c = (V_t/V_p) = 8.1/0.025 = 324 \text{ cakes/day}$$

$$\text{Maximum: } N_{c_{\max}} = 10.1/0.025 = 404 \text{ cakes/day}$$

(e) Required number of filter plates

The required number of filter plate units and the number of filtering cycles needed shall cope with 324 cakes under normal operation and 404 cakes during sludge peak production. Cake production as a function of the number of filter press units, number of plates and filtration cycles may be selected from the chart that follows:

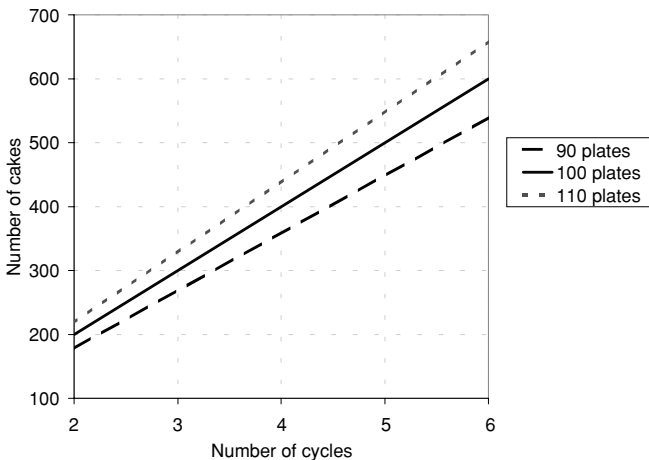

Amount of cakes produced as a function of the number of filtration cycles per day

From the chart, the following combination is able to cope with the average demand:

- One filter press with 110 plates (should a lower number of plates be selected, the number of cycles would increase with a shorter operational time length).

Example 50.7 (Continued)*(f) Duration of pressing cycles*

The number of cycles to cope with demand is:

$$N \text{ cycles} = \frac{N_c}{N_f \cdot N_p}$$

where:

N cycles = number of cycles

N_c = daily cake production (number of cakes/day)

N_f = number of filter presses

N_p = number of plates

The cycles per filter should have the following characteristics:

average: $N \text{ cycles} = 324/(1 \times 110) = 2.95 \text{ cycles/filter-d}$
 $= 3 \text{ cycles/filter-d}$

time of cycle = $8/3 = 2.7 \text{ hours/cycle}$

maximum: $N \text{ cycles} = 404/(1 \times 110) = 3.67 \text{ cycles/filter-d}$
 $= 4 \text{ cycles/filter-d}$

time of cycle = $8/4 = 2.0 \text{ hours/cycle}$

As a 2-hour cycle time is very short, at least 5 daily cycles shall be necessary to meet the maximum forecasted demand requirements.

50.7.5 Operational aspects

Filter press performance varies with the fed sludge properties and operational adjustments in the equipment control parameters. The following parameters may be adjusted by the operator:

- working pressure: according to supplier and type of equipment, the working pressure may vary within either one of the following ranges: 656 to 897 kPa (6.5–8.9 atm) or 1,380 to 1,730 kPa (13.6–17.1 atm)
- sludge feeding rate
- total filtration periods: including interim periods to operate in different pressure levels, when pressure variations are allowed during the operating cycle
- type of filter cloth: has direct influence on equipment performance
- type of filter plates: steel plates are thinner and stronger, producing a larger dewatered sludge mass per filtration cycle. Polypropylene plates are cheaper and resistant to corrosion; however, as they are 50% thicker than steel plates, their use causes a reduction in the number of plates per filter press, with a consequent reduction in the cake production per filtration cycle.

Filter press operation requires careful visual inspection before any filtration cycle begins. The operator should ensure that all filter cloths are duly coupled

without any folds and free from dirt. Torn filter cloths must be replaced. Tearing usually occurs around its central portion or at intermediate anchor points. No object shall be placed between or upon plates when the operation cycle is taking place. At the end of any working shift, the equipment must be washed up and conditions of filter cloths checked.

50.8 BELT PRESSES

50.8.1 General description of the process

Belt presses, also named **belt-filter presses**, may be divided into three distinct zones (a) gravity-dewatering zone, (b) low-pressure zone, (c) high-pressure zone.

The gravity-dewatering zone is located at the equipment entrance, where sludge is applied on the upper belt and the free water percolates through the cloth pores. Next, the sludge is routed to a low-pressure zone (also known as wedge zone), where it is gently compressed between the upper and lower belts, releasing the remainder of the free water. Within the high-pressure zone, formed by several rollers of different diameters in series, the sludge is progressively compressed between two belts, releasing interstitial water. Dewatered sludge is then removed by scrapers located on the upper and lower belts. The upper and lower belts are washed by high-pressure water jets before receiving fresh diluted sludges. The cloth washing water must have a minimum pressure of 6 kg/cm^2 and sufficient flow to remove attached sludge and polyelectrolyte residues from the cloth.

As belt presses are open, they have the disadvantage of aerosol emission, high noise level and possible foul odour emission (depending on the type of sludge). The high number of bearings (40–50 depending on the manufacturer) is another significant disadvantage of belt presses, as they require regular attendance and replacement. As advantages though, they have low initial costs and reduced electric power consumption. Recent developments in decanter-type centrifuges triggered intense competition among suppliers of both types of dewatering equipment. Despite their higher initial costs, centrifuges are being favoured so far.

Figure 50.13 presents the schematics of a typical belt press installation.

50.8.2 Performance

Typical performance of belt presses for different types of sludge can be seen in Table 50.15. A comparison with Table 50.14 (filter presses) shows that belt presses produce a cake with higher water content, for the same type of sludge.

50.8.3 Design

Belt widths are commercially available in the 0.5 m–3.5 m range (most common size is 2.0 m). Usual hydraulic loads in terms of belt width range from 1.6 to 6.3 L/s-m, varying with sludge characteristics and desired dewatering efficiency. The solids loading rates range from 90 to 680 kgTS/m-hour.

Table 50.15. Typical performance of belt presses

Type of sludge	Hydraulic load (m ³ /hour)	Solids load (kg/hour)	Solids concentration in liquid sludge (% TS)	Solids concentration in the cake (% TS)	Solids capture (%)
Anaerobic*	6.4–15	318–454	3–5	18–24	95
Aerobic**	7.3–23	181–318	1–3.0	14–18	92–95
Activated sludge	10.4–23	136–272	0.5–1.3	14–18	90–95
Raw primary	11.4–23	681–1,134	4–6	23–25	95
Raw mixed	9.1–23	454–681	3–5	23–28	95

* 50% primary/50% activated sludge in weight

** aerobically digested activated sludge

TYPICAL BELT PRESS INSTALLATION

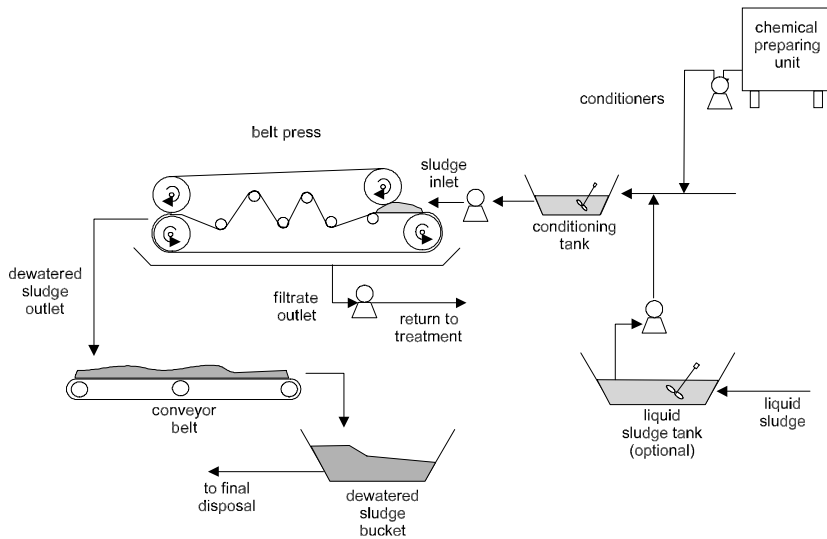

Figure 50.13. Flowsheet of a belt press installation

Example 50.8

For the wastewater treatment plant of Example 47.4 (conventional activated sludge, with anaerobic digestion of mixed sludge; population = 67,000 inhabitants), size the sludge belt press. Effluent sludge from secondary digester (influent to dewatering) has a solids load of 1,932 kgTS/d (81 kg/hour) and a solids content of 4.0% TS (specific gravity = 1.03). The dewatering period shall be 5 days/week and 8 hours/day. Other data to be considered are as follows:

- solids content in the cake = 25%
- nominal belt capacity = 272 TS/hour·m
- filtrate TS concentration = 900 mg/L

Example 50.8 (Continued)

- washing water flow = 1.51 L/s·m of belt
- cake specific gravity = 1.07
- filtrate specific gravity = 1.01

Solution:**(a) Sludge production**

- Sludge load (dry basis) = 1,932 (kgTS/d) × 7 (d/week) = 13,524 kgTS/week = 13.5 tonne TS/week
- Wet sludge = 13.5 (tonne/week) ÷ (0.04 TS × 1.03) = 328 m³/week

(b) Daily and hourly demand for dry solids processing

Based on a 5-day/week and 8-hour/day operating schedule, one has:

- Daily rate = 13.5 (tonne/week) ÷ 5 (d/week) = 2.7 tonne/d = 2,700 kg/d
- Hourly rate = 2.7 (tonne/d) ÷ 8 (hours/d) = 0.34 tonne/hour or 340 kg/hour

(c) Belt press size

Belt width:

$$B = (\text{hourly rate}) \div (\text{nominal load}) = 340 \text{ (kg/hour)} \div 272 \text{ (kg/hour}\cdot\text{m)} \\ = 1.25 \text{ m}$$

One 1.5 m width belt press plus a spare unit will be adopted.

(d) Filtrate flow based on solids and flow balances**(d-1) Solids balance**

$$\begin{aligned} \text{Solids in the sludge} &= \text{Solids in the cake} + \text{Solids in filtrate} \\ 2,700 \text{ (kg/d)} &= (S \times 1.07 \times 0.25) + (F \times 1.01 \times 0.0009) \\ &= 0.268 S + 0.0009 F = 2,700 \end{aligned}$$

where:

F = filtrate flow (L/day)

S = cake flow (L/day)

(d-2) Water balance

$$\text{Sludge flow} + \text{Washing flow} = \text{Filtrate flow} + \text{Cake flow}$$

$$\text{Daily sludge flow} = 328 \text{ (m}^3\text{/week)} \times (1/5) \text{ (week/d)} = 65.6 \text{ m}^3\text{/d}$$

$$\begin{aligned} \text{Washing water flow} &= 1.51 \text{ (L/s}\cdot\text{m)} \times 1.5 \text{ (m)} \times 3,600 \text{ (s/hour)} \\ &\times 8 \text{ (hours/d)} = 65.2 \text{ m}^3\text{/d} \end{aligned}$$

Example 50.8 (Continued)

$$65.6 + 65.2 = F + S$$

$$F + S = 130.8 \text{ (m}^3\text{/d)} = 130,800 \text{ (L/d)}$$

(d-3) Solution of the equation system

Combining Equations d-1 and d-2 above, one has:

$$0.268 S + 0.0009 F = 2,700$$

$$F + S = 130,800$$

$$F = 130,800 - S$$

Replacing it in the second equation:

$$0.268 S + 0.0009 (130,800 - S) = 2,700$$

$$0.268 S + 117.7 - 0.0009 S = 2,700$$

$$0.2671 S = 2,582$$

$$S = 9,667 \text{ (L/d) (cake flow)}$$

Therefore:

$$F = 130,800 - 9,667 = 121,133 \text{ L/d (filtrate flow)}$$

(e) Solids capture

$$\text{Solids capture (\%)} = \frac{(\text{TS}_{\text{sludge}}) - (\text{TS}_{\text{filtrate}})}{\text{TS}_{\text{sludge}}} \times 100 =$$

$$\text{Capture (\%)} = 100 \times [2,700 \text{ (kg/d)} - (121,133 \text{ (L/d)} \times 1.01 \\ \times 0.0009 \text{ (kg/m}^3\text{)})] / 2,700 \text{ (kg/d)}$$

$$\text{Capture (\%)} = 96\%$$

(f) Operating conditions

Under normal circumstances, the operating time is:

$$\text{Operating time} = 1,932 \text{ (kgTS/d)} / [272 \text{ (kg/hour.m)} \times 1.5 \text{ (m)}] = 4.7 \text{ hours}$$

During peak daily production, working shift periods should be proportionately longer. For instance, if the peak daily factor is 1.5 (daily production equal to 1.5 times the average daily production), the operating time will be $1.5 \times 4.7 = 7.1$ hours. In case the spare unit is used, the operating time is reduced.

50.8.4 Operational aspects

The main variables influencing belt press performance are listed below and must be controlled by the plant operator:

- Solids content in the cake
- Solids loading rate
- Solids capture
- Hydraulic loading rate
- Belt speed
- Belt tension
- Type and dosage of polyelectrolyte
- Sludge solids concentration
- Flocculation velocity
- Point of application of polyelectrolyte
- Pressure and flow of belt washing water

Similar to other mechanical dewatering equipments, belt presses demand careful maintenance and need thorough cleaning at the end of every operating shift. Special care must be taken towards spray nozzles for belt cleaning and to the belt tracking and tensioning system. Spray nozzle cleaning frequency is directly dependent upon the quality of the service water being used. When recycled plant effluent is used, a filter must be installed to ensure that washing water is free of solids that could clog the spray nozzles.

As belt presses allow exposure of the sludge during the entire dewatering process, it is essential to assure adequate ventilation to reduce adverse environmental impacts and keep the risk of high hydrogen sulphide (H_2S) concentrations low when the facility is processing anaerobically digested sludge.

50.9 THERMAL DRYING

The thermal drying process is one of the most efficient and flexible ways of reducing cake moisture content from dewatered organic industrial and domestic sludges. Thermal drying may be used for different sludge types, either primary or digested, and a feeding sludge solids content of 15%–30% is recommended (obtained through prior mechanical dewatering). The removal of water can be controlled and final solids content shall be chosen depending upon the disposal route, for instance:

- *sludges addressed to incineration*: solids content in the range of 30–35% to ensure the autothermic operation
- *sludges addressed to landfill disposal*: solids content around 65%
- *biosolids addressed to farming through retail sale (unrestricted use)*: solids contents higher than 90%

Under ideal conditions, 2,744 kJ (655 kcal) of energy are needed to evaporate 1 kg of sludge water, and it is usual to increase this value up to 100% for normal operational conditions. The total energy demand will depend on the efficiency of the selected equipment and on the type of the processed sludge. Part of this energy must come from external sources, such as fuel oil, natural gas etc. Biogas generated

in anaerobic digesters may constitute an ancillary energy source for thermal drying of wastewater sludges. The main advantages of sludge thermal drying are:

- significant reduction in sludge volume;
- reduction in freight and storage costs of the sludge;
- generation of a stabilised product suitable to be easily stocked, handled and transported;
- production of a virtually pathogen-free final product;
- preservation of biosolids fertilising properties;
- no requirements of a special equipment for land application;
- sludge is suitable for incineration or landfilling;
- product may be put into sacks and distributed by retail dealers.

Thermal drying has been historically adopted in retrofitted wastewater treatment plants that were already using some biological sludge stabilisation process, mainly anaerobic digestion. Its technology attracted considerable interest of designers and water companies especially in Europe aiming at the thermal drying of raw sludge. The suppression of the biological stabilisation stage significantly reduces capital costs, and favours the production of pellets with high organic matter content and heating value. These features add value to the product, furthering its use either in agriculture or as fuel source.

Thermal drying consists of sludge heating within a hermetically sealed environment, with evaporation and collection of the moisture. The sludge is taken out from the dryer as 2–5 mm average diameter pellets and solids content above 90% (when farming is being considered). The evaporated liquid is condensed and returns to the treatment plant headworks. The high temperature assures that the produced pellet is free of pathogens and qualified to be land-applied without restriction. The process is compact, completely enclosed, and does not allow release of foul odours. It is suitable for medium and large treatment plants with limited land availability and located next to residential areas.

Fuel consumption is the major operational component of thermal drying systems. Alternative fuel sources, such as natural gas or methane gas from anaerobic digesters or sanitary landfills, may lead to considerable reduction in operational costs. Selling the final product as class-A biosolid may reimburse a significant amount of the process expenses and help to balance the operational costs of the system.

It is important to point out that programmes for biosolids handling and resale in Europe or in North America have not yet been able to produce a positive financial balance. Sludge processing costs must be covered by water/wastewater rates.

Thermal drying is further discussed in Chapters 51 and 54.

Pathogen removal from sludge

Marcelo Teixeira Pinto

51.1 INTRODUCTION

As stated in Chapter 48, pathogenic organisms are sludge constituents that cause most concern in its processing and final disposal. Bacteria, viruses, protozoan cysts and intestinal parasites eggs are present in sewage sludges, and a significant part of them are disease-causing agents. The amount of pathogens found in the sludge is inversely proportional to the sanitary conditions of the community. Therefore, the greater the prevalence of water-borne diseases in the community, the greater will be the required care to handle the sludge, mainly when the disposal route is farming recycling.

The degree of sludge pathogenicity can be substantially reduced through stabilisation processes, such as aerobic or anaerobic digestion, as detailed in Chapter 49. However, many intestinal parasites, and mainly their eggs, are scarcely affected by conventional stabilisation processes, needing a complementary stage or even further stabilisation to achieve complete inactivation. These processes are known as PFRP (Processes to Further Reduce Pathogens).

It is important to point out that what is meant is not a complete disinfection process, since not all pathogenic organisms present in the sludge are thoroughly inactivated. The aim is to reduce the pathogenicity of the sludge to levels that will not cause health risks to the population, according to the requirements for each sludge use.

51.2 GENERAL PRINCIPLES

51.2.1 Objectives of pathogen reduction in the sludge

Pathogen reduction in the sludge is introduced into the wastewater treatment plant to assure a sufficiently low level of pathogenicity to minimise health risks to the population and to the workers that handle it, and also to reduce negative environmental impacts when applied to the soil. Therefore, the need for any complementary pathogen removal system will depend on the characteristics of the selected final disposal alternative.

Sludge application in parks and gardens with public access, or its recycling in agriculture has a higher level of sanitary requirements than other disposal alternatives, such as landfills or beneficial use in concrete molds. These requirements can be met by processes to further reduce pathogens and by temporary restrictions of use and public access.

51.2.2 Exposure and contamination hazards

Usually, the diseases are contracted only when human beings or animals are exposed to levels of pathogenic organisms that are sufficient to initiate the infection. The infective dose depends on each organism and on each individual resistance capacity. However, in terms of helminth eggs and protozoan cysts, only one egg or one cyst might be enough to infect the host.

Human exposure to the infective agent may occur through direct or indirect contact, as shown in Figures 51.1 and 51.2.

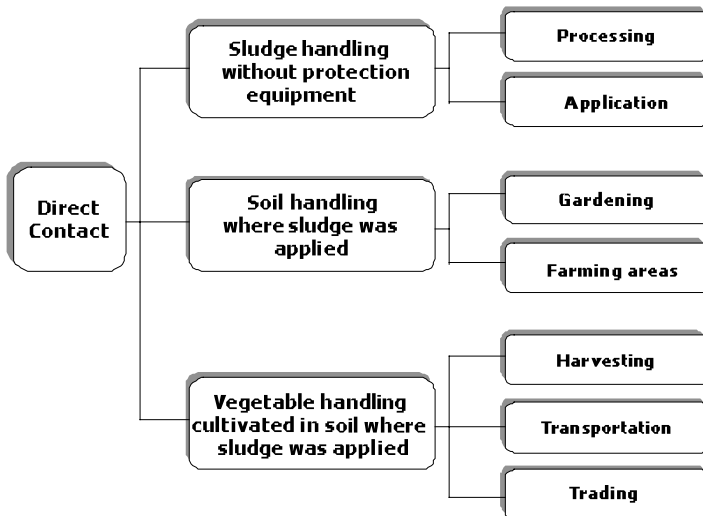

Figure 51.1. Exposure by direct contact

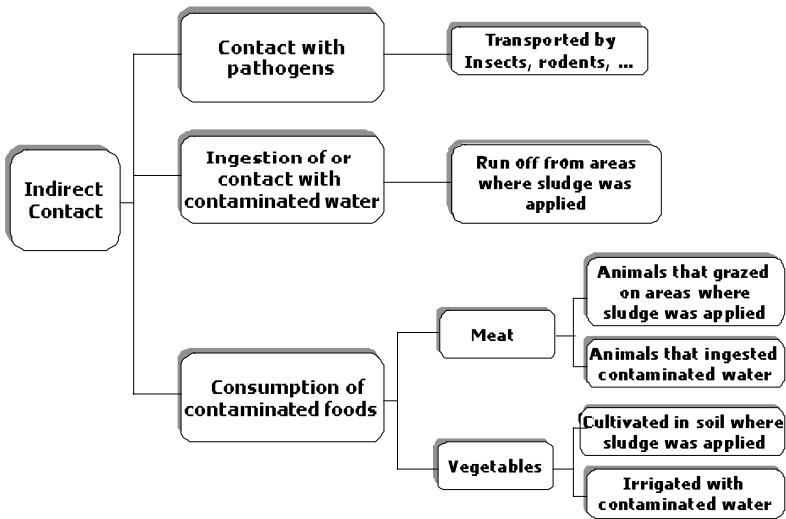

Figure 51.2. Exposure by indirect contact

When sludge is applied onto the soil, environmental conditions significantly affect the survival of pathogenic organisms. A number of organisms promptly die when in contact with hot and dry soils, but they are able to survive for long periods in wet and cold soils. Soils with low pH, organic matter and sunshine exposure (especially ultraviolet radiation) also contribute to inactivation of these organisms.

Bacteria and protozoans are not suitable as public health protection indicators because they are rapidly inactivated by environmental conditions, such as temperature and pH.

As helminth eggs have long survivability, they may be considered to be the most important indicator regarding sanitary conditions of the sludge. However, due to their large size, they usually remain not far from the point where the sludge was land applied.

Viruses, helminths and protozoans are unable to reproduce themselves out of their specific host and do not re-grow once inactivated. However, some bacteria can re-grow when suitable environmental conditions are restored, demanding extra care in any pathogen removal system.

The health of the population and animals can be protected against the potential risk of contamination by the sludge pathogenic organisms through any of the following ways:

- reduction in sludge pathogenic organisms concentration through stabilisation or processes to further reduce pathogens
- reduction of sludge pathogenic organisms transportation by vectors such as insects, rodents, birds etc., through the decrease of the sludge attractiveness to those carriers

- public access restriction to areas where sludge has been applied, for the period of time required for its natural inactivation

51.2.3 Sludge uses and requirements in different countries

Farming recycling is one of the most important and promising sludge disposal routes in most countries. Differently from others though, this alternative requires extra sanitary care, which is dealt with in many countries through use restrictions and/or sanitary requirements.

The technologies available for sludge pathogens removal seek to minimise health hazards through reduction of pathogenic organisms concentrations down to values that allow the unrestricted farming use of the sludge. In general, the limiting values adopted by many countries are very similar, with differences in the approach for use restrictions and in some process parameters.

The European Community criteria (86/278/EEC) require sludge treatment by any biological, chemical, thermal or storage process that significantly reduces the health risks resulting from sludge application to land, and allow each state member to specify its own limits to reach this general goal. This principle seems not to have worked satisfactorily, leading to a review by the European Commission, introducing clearer criteria for the state members to adopt, at least, a minimum common limiting value (Hall, 1998).

Differently from the European interpretation, the United States Environmental Protection Agency (USEPA) adopted, as a control standard and security assurance for public health, two classes of sludge microbiological quality (40 CFR Part 503). **Class-A sludges** have unrestricted use, being produced through processes that assure a concentration of organisms below detection limits, that is, sludges that underwent specific pathogen removal stages. **Classes-B sludges** are those from conventional stabilisation processes and must comply with some constraints and recommendations prior to land application.

South Africa follows a similar criterion, with the sludge being classified into four types, where **Type-C** and **D** can be used unrestrictedly in agriculture as far as pathogenicity is concerned, because the sludge has undergone proper pathogen removal processes.

Table 51.1 compares several pathogen concentration limits in various countries, aiming at achieving a safe sludge for unrestricted farming utilisation. It may be seen that the degree of stringiness varies from country to country.

51.3 MECHANISMS TO REDUCE PATHOGENS

51.3.1 Introduction

Most countries that have legislation for agriculture use of the sludge specify suitable technologies to reduce bacteria, enteroviruses and viable helminth eggs to safe

Table 51.2. Time-temperature regimes for Class-A sludges

Regime	Application	Requirements
1	Sludge with at least 7% solids (except those ones secured by regime 2)	Sludge temperature must be higher than 50 °C for at least 20 minutes (0.0139 day)
2	Sludge with at least 7% solids structured as cake, heated by contact with either warm gas or immiscible liquid	Sludge temperature must be higher than 50 °C for at least 15 seconds (0.00017 day)
3	Sludge with less than 7% solids	Sludge must be heated for at least 15 seconds (0.00017 day) but less than 30 minutes (0.021 day)
4	Sludge with less than 7% solids	Sludge temperature must be higher than 50 °C for at least 30 minutes (0.021 day)

Source: EPA (1992)

levels for unrestricted use of the biosolid. Pathogen inactivation is achieved through processes combining thermal, chemical and/or biological mechanisms.

51.3.2 Thermal treatment

Pathogenic organism reduction by thermal route combines two variables: sludge detention time and temperature. Since the sludge has different thermal diffusivities depending upon its solids concentration, USEPA proposes four different time-temperature regimes, that take into account the way the heat contacts the sludge mass, the sludge solids content, the ease of mixing the sludge and the heat transfer capacity. Table 51.2 presents the application and requirements for these four regimes for Class-A sludges.

Figure 51.3 shows the time-temperature relationship for each regime. As it is more difficult to transfer heat for more concentrated sludges (regimes 1 and 2), more conservative relationships are required. On the other hand, considering the lack of thoroughly reliable information, the same relationship is used for sludges with low solids concentrations and contact times shorter than 30 minutes (regime 3).

51.3.3 Chemical treatment

Alkaline products used for pathogen removal raise the sludge pH, consequently lethally altering the colloidal nature of the pathogenic organisms cell protoplasm, and creating an inhospitable environment.

Temperature rising can also take place simultaneously with pH increase, depending upon which product is used. This improves the effectiveness of pathogenic organisms inactivation and optimises the time-temperature relationship

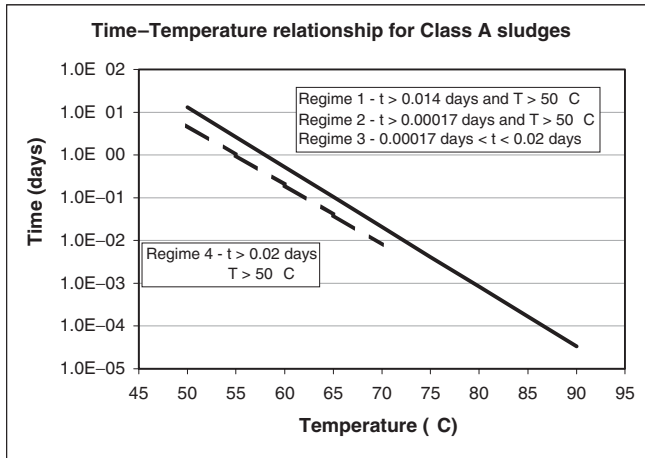

Figure 51.3. Time-Temperature relationship for Class-A sludges (t = detention time; T = temperature)

requirements. A hygienically safe sludge through this mechanism follows the steps shown below.

- Raise the sludge pH to values higher than 12 for at least 72 hours
- Maintain the sludge temperature higher than 52 °C for at least 12 hours, while pH is higher than 12
- Allow open air drying until reaching 50% solids concentration, after the pH-rising period

51.3.4 Biological treatment

The biological route for inactivation of sludge pathogenic organisms still requires further experimentation and more data consistency that would assure reproducibility and scientific acceptance. One of the most well-known alternatives is vermiculture.

Vermiculture is a process in which organic wastes are ingested by a variety of detritivorous earthworms (*Eudrilus eugeniae*, *Eisenia fetida* and others) and then excreted, producing a humus of great agronomic value that is easily assimilated by plants. When ingesting organic matter, earthworms also ingest pathogenic organisms present in the sludge, inactivating them because of their gastric activity.

However, the presence of gases like ammonia, hydrogen sulphide and carbon dioxide renders the sludge toxic for earthworms, causing their death. In spite of this, there are large-scale plants in Australia and United States, at the present time, which work with a mixture of sewage sludge and other organic wastes, reaching capacities over 400 m³ per week.

51.3.5 Treatment by radiation

Beta and gamma rays can be used to inactivate pathogenic organisms due to their action on the cell colloidal structures.

Beta rays are formed by electron accelerators under an electric field of one million volt. Their effectiveness in reducing sludge pathogenic agents depends upon the applied radiation dose. As such radiation is unable to penetrate deep through the sludge mass, its effectiveness requires that application be applied through a thin layer of liquid sludge.

Gamma rays are photons produced by radioactive elements like cobalt-60 and cesium-137. As such rays easily penetrate the sludge, this technology can be used in piped liquid flowing sludge, or even dewatered sludge cakes while being transported by belt conveyors. As EPA (1992) recommends, either way requires a minimum one-megarad dose at room temperature for effective reduction of bacteria, enteroviruses and helminth eggs to values below detectable limits. The organic matter present in the sludge is not affected by radiation, so re-growth of pathogenic organisms may occur in case of the sludge being infected again.

Solar radiation, more specifically ultraviolet rays, is well-known by its bactericidal capability. Many researchers have reported inactivation of pathogenic organisms when sludge is exposed to solar radiation. Nevertheless, very little consistent information is presently available about this issue, and whether or not it would be possible to accomplish pathogen reduction to lower the detection level thresholds.

51.4 PROCESSES TO REDUCE PATHOGENS

51.4.1 Introduction

Some processes used for the stabilisation of the organic matter in the sludge are also able to reduce, concomitantly, pathogenic organisms to allow safe use of the sludge. Some specific processes reduce pathogenic organisms to levels lower than detection thresholds and are designated as PFRP (Processes to Further Reduce Pathogens) by USEPA. The most important ones are herein described.

Sludge processing technologies for allowing unrestricted application in agriculture are somewhat similar among the various countries. However, process control variables may differ, reflecting the great variability in environmental conditions and sludge characteristics from one place to another.

Some processes discussed in this section are also covered in Chapter 49 (*Sludge Stabilisation*), since they can be applied for both stabilisation and pathogen removal.

51.4.2 Composting

51.4.2.1 General characteristics

Composting is, in most applications with sludge, an aerobic decomposition process of organic matter achieved through controlled conditions of temperature,

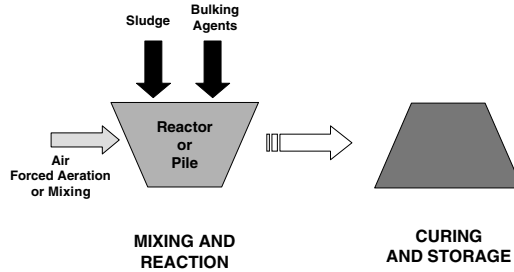

Figure 51.4. Composting process flowsheet

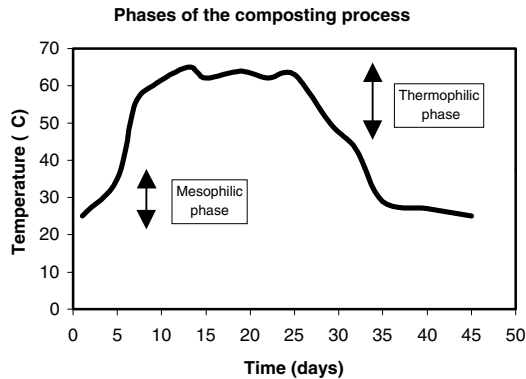

Figure 51.5. Stages of composting process

moisture, oxygen and nutrients. The resulting product from this process has great agronomic value as a soil conditioner. The inactivation of pathogenic organisms takes place mainly via thermal mechanism, brought about by the temperature rise when maximum microorganisms activity is occurring.

Both raw and digested sludge can be composted. Materials such as woodchips, leaves, green residues, rice straw, sawdust or other bulking agents must be added to the sludge to improve moisture retention, increase porosity and balance the carbon-to-nitrogen ratio.

Figure 51.4 shows a typical composting process flowsheet.

The process takes place in three basic stages, as illustrated in Figure 51.5.

- *Initial mesophilic phase.* Fast mesophilic organism growth takes place, with gradual temperature increase.
- *Thermophilic phase.* The percentage of mesophilic organisms decreases as temperature rises, leading to thermophilic bacteria and fungi growth.

These organisms have high activity and reproduction capacity, causing a further temperature rise, thus inactivating the pathogenic organisms.

- *Final mesophilic phase.* As organic matter is exhausted, the temperature lowers and the thermophilic bacteria population decreases, which enables mesophilic bacteria to establish themselves again (although with less activity, as a result of organic matter shortage).

51.4.2.2 Control parameters and environmental requirements

The main environmental requirements and control parameters for an efficient composting process are:

(a) Carbon/Nitrogen ratio

Carbon represents the energy source for composting, while nitrogen is necessary for the reproduction of bacteria (protein synthesis). The balance between these two parameters assures the effectiveness of the process.

Ideal C/N ratio for sewage sludge composting should range from **26–31** (Oorschot *et al.*, 2000). If C/N ratio is higher than this, organisms will not find enough nitrogen, have their growth limited, and the process will become slower, not reaching the temperature required for pathogen destruction. If C/N ratio is lower than the above range, nitrogen is lost due to ammonia stripping, decreasing the compost quality (Fernandes, 2000). C/N ratio must range from **10–20** by the end of the process, which is considered adequate for final disposal.

The introduction of other carbon sources helps to raise the C/N ratio, since sludge has usually very low ratios. Table 51.3 presents the carbon and nitrogen contents in the major agents used for composting.

(b) Physical structure

Sewage sludge has a very fine granulometry, which leads to air distribution problems due to lack of void space among particles. Mixing sludge with vegetable

Table 51.3. Characteristics of the major agents used for composting

Agent	% solids	% N	% C
Tree pruning	65–75	0.8–1.2	45–55
Rice straw	80–90	0.9–1.2	35–40
Sugar-cane bagasse	60–80	0.1–0.2	40–50
Wheat straw	80–90	0.3–0.5	40–50
Sawdust	65–80	0.1–0.2	48–55
Raw sludge	1–4	1–5	30–35
Digested sludge	1–3	1–6	22–30
Dry digested sludge (drying beds)	45–70	1–4	22–30
Dewatered digested sludge (belt press)	15–20	1–4	22–30
Dewatered digested sludge (centrifuge)	17–28	1–4	22–30

Source: Adapted from JICA (1993), UEL (1999), Metcalf and Eddy (1991) and Malina (1993a)

wastes, straw, woodchips and others, chopped in 1–4 cm sizes, increases the porosity within the sludge mass. A **30–35%** porosity usually allows adequate aeration. The bulking material should also lead to a satisfactory C/N ratio, as mentioned above.

(c) *Moisture*

Moisture must be monitored from the beginning to the end of the process, since it directly affects the reaction rates. Ideal water content levels are **50–60%**, with higher values hindering the passage of free air through the empty spaces, leading to anaerobic zones. Moisture values lower than 40% inhibit bacterial activity and temperature rise for pathogenic organisms inactivation.

(d) *Aeration*

Adequate oxygen supply is essential for the growth of aerobic organisms, which are mainly responsible for the process. Oxygen supply shall be enough to facilitate the reaction rate control and to assure aerobic conditions throughout the mass under composting. These are essential factors for temperature rise and inactivation of pathogenic organisms.

Some systems use natural aeration while others use forced aeration, with direct introduction of air into the mass core. Excessive aeration decreases moisture and reduces pile temperature, causing problems to the final product quality. Forced aeration systems require an accurate estimation of the oxygen needed along all process stages to assure adequate pathogen removal.

Stoichiometrically, the average oxygen demand is 2 kg O₂ per kg of volatile solids. Rates ranging from **12 to 30 m³air/hour per kg of dry mixture** are normally used in the beginning of batch processes. These rates may be increased along the process, reaching up to **190 m³air/hour per kg of dry mixture** (Malina, 1993a; WEF, 1998).

For natural aeration systems, USEPA recommends revolving the mixture at least five times during the thermophilic phase. Continuous and complete-mix systems demand about 43 kg of air per kg of mixture, which is equivalent to **1,200 m³air/hour per dry ton**. Usually 0.5–2 HP blowers are adequate for this volume.

(e) *Temperature*

Temperature is an easy-to-follow parameter that indicates the equilibrium of the biological process and hence its effectiveness. **During the first 3 days**, a temperature range between **40 °C** and **60 °C** indicates that the process is running adequately. Otherwise, some environmental requirement (C/N ratio, moisture or pH) is probably not being satisfied (Fernandes, 2000). The ideal temperature for the **thermophilic phase** is **55–65 °C**. At higher temperatures, the bacterial activity decreases and the required cycle becomes longer. At lower temperatures, insufficient decrease of pathogenic organisms may occur. The temperature control can be accomplished by increasing aeration, helping to dissipate the mixture heat released through the reaction.

Table 51.4. Temperature and time required for pathogen inactivation in composting

Organism	Exposure time (minutes)					Remark
	50 °C	55 °C	60 °C	65 °C	70 °C	
<i>Salmonella</i>	10,080		2,880			real
<i>Salmonella</i>			30		4	laboratory
Type-1 Poliovirus			60			real
<i>Ascaris lumbricoides</i>			240	60		real
<i>Ascaris</i> eggs	60	7				laboratory
<i>Mycobacteria tuberculosis</i>				20,160	20	real
<i>Escherichia coli</i>			60		5	laboratory
Faecal coliforms					60	laboratory
<i>Entamoeba histolytica</i>	5					laboratory
<i>Necator americanus</i>	50					laboratory
Virus					25	laboratory
<i>Shigella</i>	60					laboratory

Source: Adapted from WPCF (1991), JICA (1993), UEL (1999)

Table 51.4 shows the time required for inactivation of some pathogenic organisms during composting process, at several temperatures. Significant differences can be noticed between full-scale and laboratory-scale operations.

(f) *pH*

pH is an important parameter for microbial activity. The best range is **6.5–9.0**. pH reduction may happen in the beginning of the composting process, due to organic acids production, but this issue is solved as soon as the process reaches the thermophilic phase. Therefore, if the C/N ratio of the mixture is adequate, the pH will not usually be a critical factor (Fernandes, 2000).

51.4.2.3 Composting methods

The composting process can be accomplished by three main ways:

- (a) **Windrow**. The mixture is placed in long windrows (Figure 51.6), 1.0–1.8 m high, 2.0–5.0 m wide. The windrows are mechanically turned over and mixed at regular intervals, for at least 15 days (EPA, 1994) or until

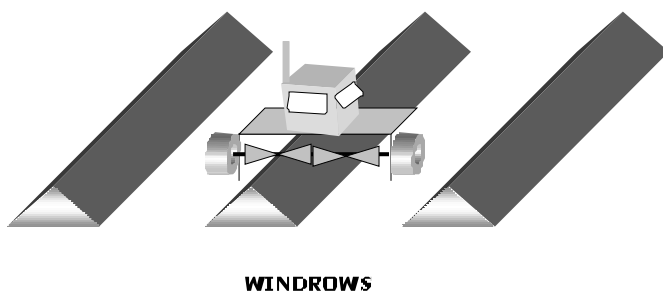

Figure 51.6. Windrows

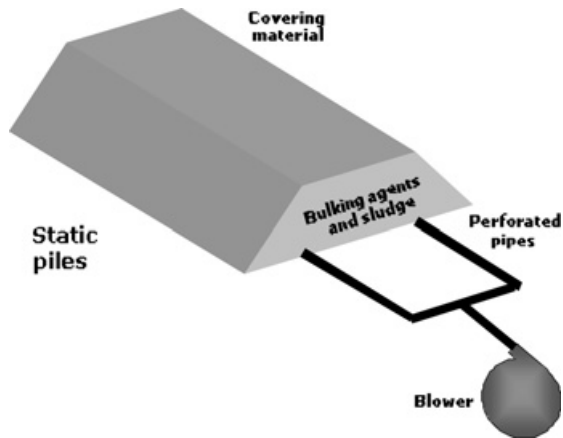

Figure 51.7. Aerated static pile

the process is completed. During this period, the temperature must be kept at least at 55 °C, which is difficult to attain in cold climate countries. The complete process (including the curing time) normally takes 50–90 days up for proper stabilisation. Windrows are usually open-air built, except in heavy rainfall areas. Aeration occurs by natural means through air diffusion into the mixture and by periodical turnover. Land requirements are the highest among the composting processes, being approximately 0.40 ha per 1,000 kg of composted dry solids per day.

- (b) ***Aerated static pile.*** The mixture is laid over a perforated pipe network, through which air is mechanically blown or aspirated (Figure 51.7). There is no turning over of the pile. The air, after passing through the pile, must be confined and treated to avoid dissemination of foul odours. This treatment can be accomplished by biological filters made up by turf, local soil, fern stems, stabilised compost and other media enabling air filtration through its mass. The thermophilic phase at 55 °C shall be kept for at least 3 days (EPA, 1992). The process is generally completed after 30–60 days, of which 14–21 days are under aeration (WEF, 1998). Land requirements for aerated static piles are about 0.13 ha per 1,000 kg of composted dry solids per day.
- (c) ***In-vessel system.*** The mixture is enclosed in vessels where all process variables are controlled and odour release is minimum. Shorter reaction times are obtained and better pathogen reduction is accomplished. They can be batch or continuously operated, depending on the project. The process is generally completed after 28–35 days, of which, at least, 14 days inside the vessel (WEF, 1998). Land requirements (around 0.06 ha per 1,000 kg of composted dry solids per day) are much smaller than with other open air processes.

Table 51.5 presents a comparison among the three composting methods.

Table 51.5. Comparison among the composting methods

Composting methods	Advantages	Disadvantages
Windrow	Low investment cost Low O & M cost	Large land requirements Possible odour problems Difficulty in reaching the necessary temperature Potential mixing problems Long composting period
Aerated static pile	Better odour control Better conditions for maintaining temperature Lower reaction time	Investments for the aeration system Moderate O & M costs
In-vessel system	Low land requirements High degree in process control Ease in controlling temperature and odours	Higher investment and O & M costs Economically applicable only for large scale

O & M = operation and maintenance

Example 51.1

Design a windrow composting system for the sludge from Example 47.1 (dewatered in drying beds), using tree pruning as bulking agent.

Solution:

(a) Sludge characteristics

- Sludge production = 4 m^3 per day = 4.2 tonne/day
- Solids concentration = 60% (drying bed dewatered sludge)
- Nitrogen content = 2.5 % (assumed, Table 51.3)
- Carbon content = 25 % (assumed, Table 51.3)

(b) Bulking agent characteristics (Table 51.3)

- Solids concentration = 70%
- Nitrogen content = 1%
- Carbon content = 50%

(c) Required quantities for windrow formation

• C/N ratio

C/N ratio must be in the 26–31 range. The C/N ratio for a sludge and tree pruning mixture in equal parts with the above mentioned characteristics will be:

$$\text{Mixture C/N ratio} = (25\% + 50\%)/(2.5\% + 1\%) = 21.4\%$$

Example 51.1 (Continued)

This ratio is too low for composting and needs to be raised by changing the proportion of input material. Making the mixture C/N ratio equal to 30 and adopting a “1” portion of sludge to “Y” pruning parts, the following relationship will stand:

$$30\% = (25\% + 50\% \times Y)/(2.5\% + 1\% \times Y)$$

$$Y = 2.5$$

This means that 1 part of sludge (in weight) should be mixed with 2.5 parts of pruning leftovers. Thus, for 4.2 tonne/d of sludge, 10.5 tonne/d of tree pruning will be required.

As sludge production is continuous, the required pruning amount must be continuously available. Therefore, a careful evaluation of the availability of this material is recommended. Furthermore, it should not be forgotten that the material to be disposed of has increased almost three times its original quantity.

- *Moisture*

The moisture must be set up in the 50%–60% range. Similarly to the C/N ratio calculation, one has:

$$\text{Mixture moisture} = (\text{Sludge moisture} \times 1 + \text{Pruning moisture} \times 2.5)/(1 + 2.5)$$

$$\text{Mixture moisture} = (40\% \times 1 + 30\% \times 2.5)/3.5$$

$$\text{Mixture moisture} = 32.8\%$$

This is low, compared with the recommended values. The following alternatives may be considered:

- Earlier removal of the sludge from the drying beds, since a sludge with a greater moisture content (lower solids content) is needed
- Use of a wetter bulking agent
- Addition of water to the mixture

In the first alternative, the required moisture of the sludge removed from the drying beds needs to be calculated. Assuming “Y” as the sludge moisture:

$$50\% = (1 \times Y + 30\% \times 2.5)/3.5$$

$$Y = 100\% \text{ (which means that the liquid sludge instead of the dewatered one should be used)}$$

If a wetter bulking agent is being considered (second alternative), its required moisture level Y is:

$$50\% = (40\% \times 1 + 2.5 \times Y)/3.5$$

$$Y = 54\%$$

Example 51.1 (Continued)

If water is added to the mixture (third alternative), the following amount of water is required:

Original mixture moisture = 32.8% (or 67.2% solids = 672 kg solids/m³)

Mixture moisture after additional water = 50% (or 500 kg solids/m³)

Total mass of material = 4.2 tonne sludge + 10.5 tonne pruning
= 14.7 tonne/day

Existing volume of water = (14,700 kg of mixture)/(672 kg/m³) = 21,875 m³

Assuming “Y” as the volume of water to be added, one has:

$$500 = 14,700 / (21,875 + Y)$$

$$Y = 7,525 \text{ m}^3 \text{ (say, about one 8 m}^3 \text{ water-truck per day)}$$

(d) Windrow volume

Mass for daily composting = 14.7 tonne/d

Assuming 30% of void space and a specific weight of 1.1 for the mixture:

$$\text{Volume of material} = 14.7 \times 1.3 / 1.1 = 17.372 \text{ m}^3/\text{d}$$

Assuming a 1.5-m high, 3.0-m wide triangular pile:

$$\text{Pile length} = (17.372 \text{ m}^3/\text{d}) / [(3.0 \text{ m} \times 1.5 \text{ m}) / 2] = 7.7 \text{ m}$$

A 7.7 m × 3.0 m × 1.5 m pile per day shall be built.

(e) Area required

Allowing a 4.0 m lateral circulation around each pile:

$$\text{Pile area} = (7.7 \text{ m} + 2.0 \text{ m}) \times (3.0 \text{ m} + 2.0 \text{ m}) = 48.5 \text{ m}^2$$

Considering 15 days as the required time to complete the composting, the area required for 15 piles is:

$$\text{Composting area} = 15 \times 48.5 \text{ m}^2 = 727 \text{ m}^2$$

An additional area is required to store the product while it is being cured for the next 40 days:

$$\text{Curing area} = 40 \times 48.5 \text{ m}^2 = 1,940 \text{ m}^2$$

Assuming 50% of the area for stock room, office, truck loading and transit and others:

$$\text{Total area required} = (1,940 \text{ m}^2 + 727 \text{ m}^2) \times 1.5 = 4,000 \text{ m}^2$$

For the population of 100,000 inhabitants, the per capita land requirement is 4,000 m²/100,000 inhabitants = 0.04 m²/inhabitants.

51.4.2.4 Operational troubleshooting

Table 51.6 presents an operational troubleshooting guide for sludge composting systems.

51.4.3 Autothermal thermophilic aerobic digestion

51.4.3.1 Overview

The autothermal thermophilic aerobic digestion (ATAD) process follows the same principles of conventional aerobic digestion systems, with the difference that it operates in the thermophilic range due to some changes in the conception and operation of the system. ATAD systems are also covered in Section 49.3.4.

In this process, the sludge is usually previously thickened and operates with two aerobic stages, not requiring energy input to raise the temperature. As the reaction volume is smaller, the system is closed and the sludge solids concentration is higher, the heat released from the aerobic reactions warms the sludge. Temperatures may be higher than 50 °C in the first stage and 60 °C in the second stage. The typical heat production is as high as 14,000 kJ/kgO₂, and the oxygen demand reaches **1.42 kg O₂ per kg oxidised VSS**.

Due to the temperature rise, the process can achieve 60% of VSS removal in a relatively short time. Pathogenic organisms are safely reduced to values lower than the detection limits if the sludge is kept in a 55 °C–60 °C temperature range for 10 days (EPA, 1994). However, treatment plants in Germany are designed for 5 to 6 days (2.5 through 3 days per reactor in series), reaching the same results in terms of pathogen reduction (EPA, 1990).

51.4.3.2 Operational regime

The reactors operate with daily semi-batches, in accordance with the retention time defined by the project. This operational regime is an important factor for the effective destruction of pathogenic organisms. Once a day the following sequence takes place:

- aeration and mixing for both reactors are turned off
- part of the sludge from reactor-2 is discharged into the sludge holding tank, lowering the reactor water level
- part of the sludge from reactor-1 flows by gravity to reactor 2
- fresh raw sludge is pumped into reactor 1
- aeration and mixing are both turned on again

All this operation takes about 30 minutes, resulting in an average net reaction time of 23.5 hours.

51.4.3.3 Design considerations

As oxygen transfer into high solids concentration sludges (4% to 6% of total solids) is difficult, mixing and aeration effectiveness are the major factors governing the

Table 51.6. Operational troubleshooting guide for sludge composting systems

Method	Problem	Cause	Solution	
Aerated Static Pile	The pile does not reach 50–60 °C in the first days of operation	Poor mixing of sludge and bulking agent	Check the oxygen. If it is higher than 15%, reduce aeration.	
		The pile is too wet	Increase aeration to reduce moisture. As soon it reaches 50–60%, reduce aeration.	
		Over aeration	Reduce aeration. If the temperature does not rise after 2 or 3 days, the pile must be remixed.	
	The temperature does not remain between 50–60 °C for more than 2 days	Poor mixing of sludge and bulking agent	Keep oxygen within the 5–15% range.	
		The pile is too wet	Increase aeration to reduce moisture. As soon it reaches 50–60%, reduce aeration.	
		Over aeration	Reduce aeration. If the temperature does not rise after 2 or 3 days, the pile must be remixed.	
Odour in pile		Low volume of applied air	Check the blower. Check if the pipes are clogged.	
		Poor mixing of sludge and bulking agent	Raise the volume of air blown to reduce anaerobic condition.	
		Non-uniform air distribution	Check for water within air pipes or pipes clogging condition. Verify manifold project.	
Windrow	The pile does not reach 50–60 °C in the first days of operation	Poor sludge and bulking agent mixing	Reduce the cycle time between mixings	
		The pile is too wet	Protect pile against bad weather and reduce cycle time between mixings	
		Over mixing	Increase the cycle time between mixings	
	The temperature does not remain between 50–60 °C for more than 2 days	Inadequate sludge mixture with bulking agent	Reduce the cycle time between the mixings	
		The pile is too wet	Protect pile against bad weather and reduce cycle time between mixings	
		Over mixing	Increase the cycle time between mixings	
	Odour in pile		Poor mixing	Reduce the cycle time between the mixings
			Poor mixing of sludge and bulking agent	Reduce the cycle time between the mixings

Table 51.7. Design criteria for ATAD systems

Parameter	Characteristics
Reactor characteristics	Cylindrical reactors, with 0.5–1.0 height/diameter ratio If diffused air is used, increase height/diameter ratio to 2–5
Sludge feeding	4–6% TS (VS > 2.5%)
Detention time	5–10 days
Temperature	Reactor 1: 35–50 °C Reactor 2: 50–65 °C
Air requirements	4 m ³ /hour per m ³ of reactor active volume
Power level	85–105 W/m ³ of reactor active volume
Energy required	9–15 kWh per m ³ of sludge
Energy recovered	20–30 kWh per m ³ of sludge

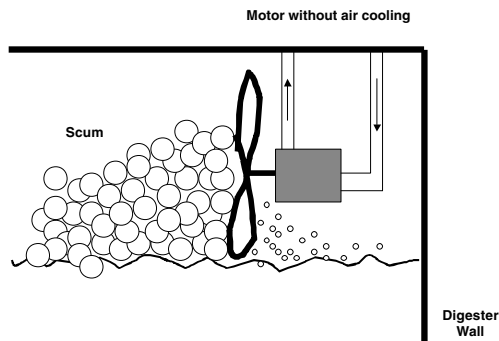

Figure 51.8. Scum and foam controller

operational success. Thus, aerators location, reactors geometry and turbulence conditions are all important design aspects to be considered. Table 51.7 shows typical design criteria for ATAD system.

Oxygenation efficiencies from mechanical aerators operating with 5% total solids concentration sludges are about **1.8 kgO₂/kWh** (standard conditions).

A scum control system must be provided in the reactors, requiring a 0.5–1.0 m freeboard for its installation. Figure 51.8 exemplifies a simple system with a mechanical propeller inside the reactor, which breaks the scum and foam above a certain water level.

The reactor needs to be protected against heat loss by a 10-cm insulation layer.

The sludge holding tank is usually uncovered and equipped with a mixer. Very few problems concerning odour and pathogen re-growth are expected if the sludge is properly stabilised.

51.4.4 Alkaline stabilisation

51.4.4.1 Introduction

Alkaline stabilisation is used for treating primary, secondary or digested sludges, either liquid or dewatered. The process occurs when enough lime is added to the sludge to increase the pH to 12, resulting in a reduction in the percentage of organisms and in the potential occurrence of odours.

51.4.4.2 Liquid sludges

Quicklime (CaO) and hydrated lime [$\text{Ca}(\text{OH})_2$] are the most employed products. However, quicklime does not mix easily with liquid sludge and needs to be slaked before application. Hydrated lime is often applied to liquid sludge, which facilitates its mixing, enabling sludge solids and lime to remain suspended in the contact tank.

After a contact time in the mixing tank of about 30 minutes, the sludge is routed for dewatering or immediate land application. As the organic matter is not affected by this process, non-digested sludges must be disposed of before its deterioration starts, avoiding foul odours and minimising risks of pathogenic bacteria re-growth. Figure 51.9 shows a typical flowsheet in which lime is added to a liquid sludge.

The necessary lime dosages for reaching a pH of 12 depend on a number of requirements, such as solids levels, type of sludge, its buffering conditions and others. Table 51.8 suggests some doses as starting values, for later assessment if the mixture has reached the desired pH.

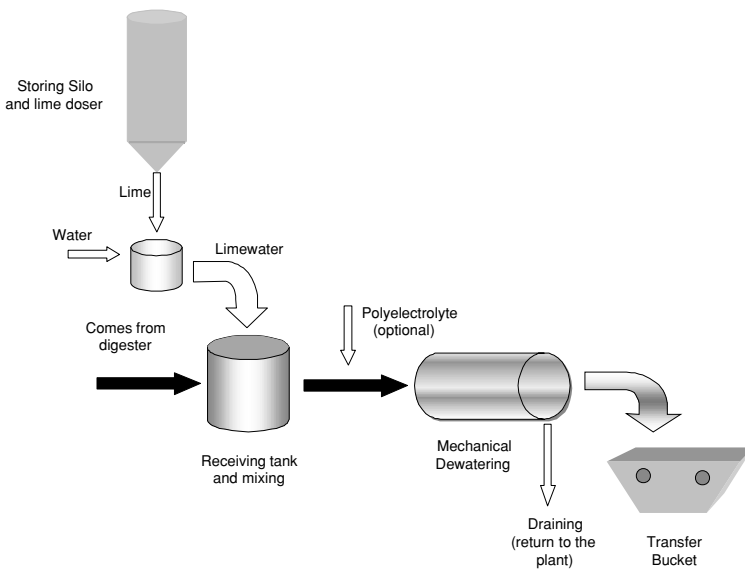

Figure 51.9. Flowsheet of a typical liquid sludge stabilisation system using lime

Table 51.8. Amount of required lime (pH = 12)

Type of sludge	kg Ca(OH) ₂ per tonne of dry solids	Final pH
Primary sludge	54–154 (110)	12.7
Activated sludge	190–350 (270)	12.6
Anaerobic sludge	125–225 (170)	12.4

Source: Adapted from Malina (1993b)

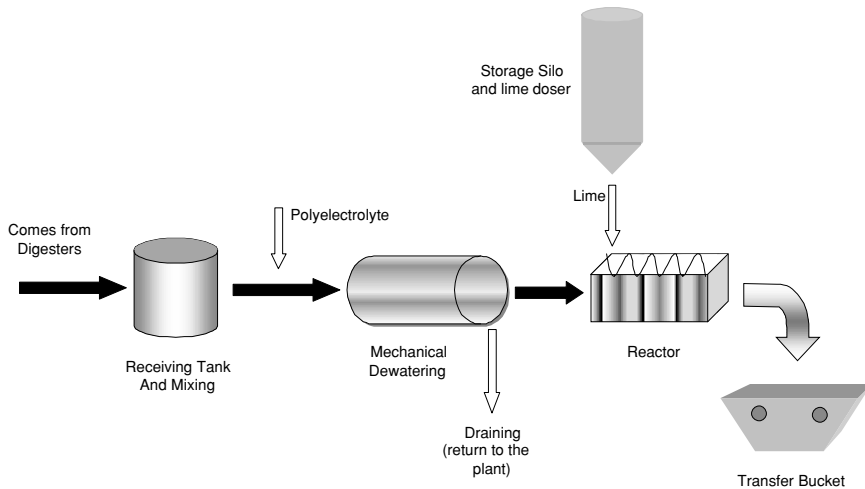

Figure 51.10. Flowsheet of a typical dewatered sludge stabilisation system using lime

The lime-treated liquid sludge is easily dewatered by mechanical equipment, making it suitable for final disposal.

51.4.4.3 Dewatered sludges

Quicklime (CaO) is considered the best product to react with sludges already in the solid phase, since it reacts with the moisture and releases heat. Several studies (Oorschot *et al.*, 2000; Andreoli *et al.*, 1999; EPA, 1992, 1994) have shown that the addition of **30–50% of CaO on a dry weight basis** (0.3 to 0.5 kg CaO per kgTS) to sludge leads to biosolids with pathogenic organisms below the detection threshold. Hydrated lime can also be used, although a significant increase in sludge temperature is not attained, therefore requiring a longer contact time. Figure 51.10 shows a typical flowsheet for the stabilisation of a dewatered sludge using lime.

51.4.4.4 Advantages and disadvantages of alkaline stabilisation

Alkaline stabilisation may present some problems, such as foul odour emission due to ammonia stripping resulting from the pH rise. This is particularly noticeable in

anaerobically digested sludges due to the higher ammonia concentration occurring in this process. Although ammonia helps in the removal of pathogens (Sanepar, 1999), the obnoxious odours may pose problems to the workers' health. Attenuation of the problem may be achieved by confinement of the system and gas treatment (scrubbers and air sealed units).

The second problem is related to the increase of solids for disposal. Although in many cases the soil requires pH correction, lime stabilisation leads to a larger amount of solids, increasing transportation and disposal costs.

On the other hand, alkaline stabilisation is an easy and simple technology and does not require high investment or very sophisticated equipment. Therefore, it may be a feasible alternative for small treatment plants or in emergency cases. For other situations, a careful assessment of its economic feasibility is needed.

51.4.4.5 Design and operational aspects for alkaline stabilisation of dewatered sludges

An effective lime and sludge mixing is essential to attain adequate stabilisation and pathogen removal. Furthermore, low-moisture sludges mixed with quicklime have small changes in temperature, losing an important complementary factor for pathogen removal. It is strongly recommended that lime be added when the sludge moisture is at least 60–75%, allowing both an adequate mixing and an exothermic heat releasing reaction from quicklime and the remaining sludge moisture (Sanepar, 1999).

Lime can be mixed with sludge through simplified batch processes (manual, concrete mixer) or continuously by industrial equipments.

- ***Simplified systems.*** Manual mixing can be made with spade and hoe. Lime is spread over the sludge surface, while it is still on the drying beds, making a pile out of the two components after mixing. Temperature must be monitored and kept from lowering through pile mixing (Sanepar, 1999). This alternative is somewhat inefficient due to mixing and homogenisation difficulties, both being essential features for an efficient sludge pathogen removal. Another alternative is to use an ordinary concrete mixer, which must be loaded with an adequate mixture of sludge-lime, using about 40% of the active equipment capacity. Mixing takes place for about 3 minutes, followed by unloading for maturation (Sanepar, 1999).
- ***Industrial systems.*** Industrial equipments for lime and sludge mixing are produced by several manufacturers. Continuous operation is their major advantage, and they are able to achieve an efficient homogenisation of both components, thanks to ancillary equipment such as lime dosage regulators and mixers.

After mixing, the sludge must remain in a covered place through 60–90 days for completion of the pathogen removal to reduce heat loss and to protect sludge

against rainfall. During this period, the pH must be kept around 12 to assure an inhospitable environment for pathogenic organism re-growth.

Sludges that are not adequately stabilised (at least 38% volatile solids reduction) need to be better processed before lime application, because aggressive odours may evolve during storage.

Example 51.2

For the sewage treatment plant defined in Example 47.1, estimate the lime and limed sludge produced to be disposed of.

Data:

- Volumetric sludge production = 40 m³/d
- Sludge mass production = 1,500 kg SS/d

Solution:

(a) Dewatering

Sludge dewatering before lime addition shall be adjusted for a 25%–40% solids range. Therefore, if drying beds are used, it is important that sludge be removed before the 60% moisture (40% solids) is reached. The following cake production may be expected, assuming centrifuged sludge dewatering (25% solids cake and 98% solids capture):

$$\begin{aligned}\text{Sludge mass} &= 1,500 \times 0.98 = 1,470 \text{ kg SS/d} \\ \text{Cake mass (25\% SS)} &= (1,470 \text{ kg SS/d}) / (0.25) = 5,880 \text{ kg cake/d}\end{aligned}$$

(b) Lime needed

Assuming 30% lime dose on a dry-weight basis:

$$\text{Amount of lime} = 1,470 \text{ kg SS/d} \times 0.3 = 441 \text{ kg/d CaO}$$

(c) Sludge to be disposed of

$$\begin{aligned}\text{Amount of sludge for disposal} &= 5,880 \text{ kg/d cake} + 441 \text{ kg/d CaO} \\ &= 6,321 \text{ kg/d sludge}\end{aligned}$$

51.4.4.6 Operational troubleshooting

Table 51.9 presents some common problems, causes and solutions encountered in the alkaline stabilisation process.

51.4.4.7 Other technologies using alkaline agents

Several technologies using variants of lime stabilisation are being offered. Some of them use other additives replacing lime (partially or thoroughly), and reach the

Table 51.9. Common problems in the alkaline stabilisation process

Problem	Causes	Solution
Quicklime is running out of its thermal reaction capability	Air moisture was absorbed during storage, transportation or transfer	Keep storing silo closed and be careful in transportation and transfer
Mixer is locking	Sludge and/or lime feeding is excessive	Adjust dosage
Sludge does not reach the desired temperature	Sludge moisture may be out of optimum range	Adjust sludge moisture
	Quicklime is little reactive	Check lime thermal reaction capability
	The mixture is not adequate	Check mixer
Sludge releases odour after stabilisation	Lime dose was low	Check pH controller and adjust dosage

same removal level of pathogenic organisms. Some examples are:

- *RDP Envessel*: Dewatered sludge is heated before lime addition through a patented equipment that homogenises and heats the mixture, reaching temperatures up to 70 °C. The sludge is then unloaded in furrows and kept for a period not shorter than 15 days.
- *N-Viro*: Dewatered sludge is mixed with quicklime, kiln-dust (a cement industry waste) and an inert product, producing a biosolid with a low odour potential, better granulometry for handling and land application, and safe in terms of pathogenicity.

51.4.5 Pasteurisation

Pasteurisation involves sludge heating up to 70 °C for 30 minutes, followed by a fast cooling down to 4 °C.

The sludge can be heated by heat exchangers or through heated vapour injection. The vapour injection process is more frequently used and the sludge is pasteurised in batches to reduce recontamination risks.

Lately, pasteurisation as a final stage is being gradually discontinued; pre-pasteurisation followed by mesophilic digestion is now the preferred choice, due to some problems concerning *Salmonella* re-growth (EPA, 1993).

Laboratory investigations have proved that pasteurisation of sludges from UASB reactors was able to reduce 100% of faecal coliforms and helminth eggs viability, independently from the solids concentration. However, obnoxious odours evolved after thermal treatment (Passamani and Gonçalves, 2000).

51.4.6 Thermal drying

The application of heat for sludge drying and pathogen removal has been practised for years in several countries. Older technologies, although effective, lacked a good energetic balance. More efficient drying equipment and the growing

environmental safety concerns regarding biosolids disposal brought back the debate on this technology again.

In thermal drying, the sludge passes through a heat source that evaporates its water, hence leading to thermal inactivation of organisms. Thermally dried sludge must be previously digested and dewatered up to about 20–35% solids to be economically feasible. Dried sludge has granular appearance and **90–95% solids content**.

Under ideal conditions, 1 kg of water requires 2,595 kJ (0.72 kW) for evaporation, which can be supplied by any heat source, including biogas. As the heating power of biogas is 22 MJ/L and burners can work at 70% efficiency, under ideal conditions, **0.17 litres of biogas are required to evaporate 1 kg of water**. Besides this, energy losses (through walls, air and others) shall also be accounted for, together with the energy required to increase the sludge temperature to slightly above 100 °C, when the evaporation process starts.

The major types of thermal drying systems are:

- *Direct contact dryers*: where hot air has direct contact with the sludge, drawing away moisture, gases and dust
- *Indirect contact dryers*: where heat is transmitted through heat exchange plates

Both systems require equipment for enclosure and treatment of water vapour and dust released from the dryers to avoid odour and particle emissions to the atmosphere.

51.4.7 Other pathogen removal processes

Other processes, such as *incineration* and *wet oxidation*, are operationally more complex and require more capital costs to be implemented. Final products from these processes are inert, sterile, and may serve as concrete aggregate, landfills and alike.

51.4.8 Comparison among processes

A comparison among several process characteristics is shown in Tables 51.10 and 51.11.

51.5 OPERATION AND CONTROL

51.5.1 Operational control

Monitoring the pathogen removal systems aims to ensure a final product meeting microbiological quality requirements, meaning that the concentrations of pathogenic organisms and indicators (*Salmonella* or faecal coliforms, viable helminth eggs and enteroviruses) are below the detection threshold. It should be understood that this is not simply a matter of taking samples, and that the

Table 51.10. Comparison among sludge pathogens removal technologies. Implementation

Process	Area	Skilled personnel	External power	Chemicals	External biomass	Construction cost	O and M cost
Composting (windrow)	+++	+	+/+++	+	+++	+	+
Composting (in-vessel)	++	++	++	+	+++	++	++
Autotherm. aerobic digest.	++	++	++	+	+	++	++
Pasteurisation	++	++	+++	+	+	++	++
Lime treatment	++	+/+++	+	+++	+	+	++
Thermal drying	+	+++	+++	+	+	+++	+++
Incineration	+	+++	+++	+	+	+++	+++

+++ : Significant importance; ++ : Moderate importance; + : Little or non-existent importance

Table 51.11. Comparison among sludge pathogens removal technologies. Operation

Process	Effect against pathogens			Product stability	Volume reduction	Odour potential	Remarks
	Bacteria	Viruses	Eggs				
Composting (windrow)	+++/>++	++/>+	+++/>++	+++	↑	+++	Effect depends on mixture
Composting (in-vessel)	+++	+++/>++	+++	+++	↑	++	Effect depends on mixture
Autothermal aerobic digestion	+++/>++	+++/>++	+++	++	++	++	Effect depends on operational regime
Pasteurisation	+++	+++	+++	++	+	++	Must be previously stabilised
Lime treatment	+++/>++	+++	+++/>++	++/>+	↑	+++/>++	Effect depends on maintaining pH
Thermal drying	+++	+++	+++	+++	+++	+	Stabilisation and total inactivation
Incineration	+++	+++	+++	+++	+++	+	Stabilisation and total inactivation

+++ : Significant importance; ++ : Moderate importance; + : Little or non-existent importance

↑ : Volume increase

monitoring process should be able to assure that the biosolids beneficial use will not bring forth public health hazards or negative environmental impacts.

Sufficient information must be collected during sludge processing to properly assess whether the system is running as recommended. How information is collected and how frequent sampling must take place varies with the process used.

For instance, the aerated static pile composting process requires that the sludge temperature must be kept at least at 55 °C for more than 3 days, according to USEPA recommendations. Through continuous or intermittent measurements, the operator must ensure that this parameter is adequately maintained throughout the

process, and that the measurements really represent the operational conditions of that pile.

Frequently, the process does not behave as predicted. The operator is supposed to record the data of this particular pile for further consideration, when the final product microbiological assessment takes place, to verify whether it should be released or not for disposal.

51.5.2 Requirements for the sludge

To produce a pathogen-free sludge, the operators must assure that concentrations of *Salmonella*, enteroviruses and viable helminth eggs are below the detection thresholds attained by the current analytical methodology.

Faecal coliform and viable helminth eggs have been adopted by some companies (Brazil, Sanepar, 1999) as indicator organisms on the grounds that if their concentrations are kept within the legislation limits the other organisms are also likely to be below the allowable limits. This principle recognises that the long survival capability of helminth eggs under unfavourable environmental conditions should guarantee that a particular biosolid would be suitable for land application.

It is important to mention that the threshold value for the concentration of faecal coliforms represents the geometrical mean of the values found in the samples taken in the monitoring period, defined in Section 51.5.4, and not its arithmetic mean.

51.5.3 Avoiding re-growth

Viruses and helminths, after inactivation, are not capable of appearing again in the sludge, except when external recontamination occurs. On the other hand, pathogenic bacteria may reappear in sludge. Some reasons why this occurs are:

- the sludge is not well stabilised
- the environmental conditions (pH e temperature) which led to pathogen removal are already attenuated
- cross-contamination takes place between the sludge being processed and the final sludge

The conditions that led to pathogen removal must be kept until transportation and final disposal. In addition, any contact between the sludge being processed and the final sludge must be avoided.

51.5.4 Monitoring

51.5.4.1 Requirement and frequency

The monitoring of pathogenic organisms concentration presents two particular problems. The first one concerns the laboratory processing time (about 3–4 days for faecal coliforms and up to 4 weeks for verification of viable helminth eggs). The

Table 51.12. Monitoring frequency

Yearly production (tonne/year)	Frequency
Up to 300	Yearly
From 300 to 1,500	Quarterly
From 1,500 to 15,000	Bimonthly
Above 15,000	Monthly

Source: Adapted from EPA (1994, 1995)

second problem is related to the wide variability of the analytical results, whereby one single sample is unable to assure the sludge sanitary quality.

To cope with this situation it is advisable to adopt a **2-week monitoring period with approximately seven samplings**. This means that, at least, for 6 weeks, the sanitary quality of the sludge is not known, and hence it should not be routed for final disposal. As a consequence, a storage area is required within the treatment plant, where the sludge shall be duly kept prior to its releasing.

Table 51.12 suggests a minimal monitoring frequency for biosolids that will be land applied. However, the sampling may be intensified in communities with significant records of water-borne diseases.

In the case of yearly frequencies, the operator must choose the most critical period of the year, that is, the one in which the worst performance is expected.

51.5.4.2 Sludge sampling for microbiological analyses

Sewage sludge presumably contains pathogenic organisms, needing to be properly handled to protect operators and laboratory staff. These professionals should be properly trained on sanitary precautions and be given safety equipment, such as gloves, eyeglasses and others, to properly handle the sludge with minimum risks.

All samples for microbiological tests should not be frozen, but rather be preserved at a temperature range of 4–10 °C and processed not later than 24 hours after being collected. Ice and sample shall not have direct contact. All material used for sampling, including the sample containers, must be sterilised (for assessment of compliance with requirements for sludges following pathogen removal).

Samples must be representative of the situation that is being assessed. For instance, thick sludges usually have a concentration gradient, and thus the samples must be collected and mixed from several points throughout the system, both vertically and horizontally. Liquid sludge samples from a tank require discarding the initial volume, which is usually affected by the conditions in the pipe.

51.5.4.3 *Before and after measures for sampling for microbiological analysis*

The following steps assure reliability of sampling, and therefore represent the results and laboratory safety.

- *Before sampling:*
 - be sure that the laboratory can receive the samples for analysis within the maximum preservation period
 - check whether all equipment and materials that will be used are washed and sterilised (for sludges following pathogen removal)
 - check whether all flasks are identified
 - check whether the system is running normally
- *After sampling and analysis:*
 - assure that all flasks are closed and well packed
 - wash all materials used in sampling before taking them to the laboratory to be sterilised
 - put the remainder unused samples into the autoclave before disposal

Assessment of sludge treatment and disposal alternatives

*F. Fernandes, D.D. Lopes, C.V. Andreoli,
S.M.C.P. da Silva*

52.1 INTRODUCTION

The evaluation of alternatives for sewage sludge treatment and final disposal is usually complex, due to the interaction of technical, economical, environmental and legal aspects. Although complex and expensive, final sludge disposal is often neglected in the conception and design of wastewater treatment systems. Operators sometimes need to handle the final disposal of the sludge on an emergency basis, with all the burden of high costs, operational difficulties and undesirable environmental impacts that might undermine the benefits of the wastewater treatment system.

Because sludge management represents a considerable percentage (20–60%) of the operational cost of a wastewater treatment plant, the choice of the sludge processing methods and final destination alternatives should not be overlooked in the design of the wastewater treatment plant, and must be considered a part of the treatment plant itself.

The current chapter presents some basic guidelines that should be taken into account during the assessment of sludge treatment and final disposal alternatives.

Existent plants require additional studies regarding land availability, retrofitting, use of already built facilities and/or advantages of building new ones.

52.2 SUSTAINABLE POINT OF VIEW

A hierarchical structure of alternatives is raised automatically when sludge treatment and final disposal alternatives are focused under a sustainable policy point of view. In this case, the following objectives should be attained:

- sludge volume reduction through proper wastewater treatment technology. Although different treatment processes usually have different sludge productions, there is little flexibility to decrease sludge volumes, since usually the higher the wastewater treatment efficiency, the higher the sludge production
- sludge quality improvement through proper management of industrial wastewater in public sewerage systems, with emphasis on their metal content to preserve the possibility of agricultural application of the sludge
- recycling of the produced sludge to the maximum extent. Biosolids land application in crops, pastures and forestry is a worldwide-accepted alternative, together with land reclamation.

From a sustainable point of view, only when the sludge quality makes its beneficial use unfeasible, landfilling or incineration should be considered. Even considering some heat recovery in incineration, its energy balance is negative due to the high water content of the sludge.

Several countries have already adopted economical and legal instruments fostering sludge recycling, and increasing restraints to landfills, deeply influencing decisions regarding the final disposal of wastewater sludges.

52.3 TRENDS IN SLUDGE MANAGEMENT IN SOME COUNTRIES

Sludge production in many countries is dramatically increasing as a consequence of the growth in sewerage and treatment systems. Along with the increase in sludge production, more stringent regulations in terms of a better biosolids quality are gradually being enforced, aiming to minimise adverse sanitary and environmental impacts. These changes are leading to more effective managerial practices, considering the rising trend of final disposal costs.

More mechanical dewatering systems are being used lately because of their improved efficiency in water removal. There is a growing interest in thermal drying, sludge pelletisation and other advanced processes that aim to improve biosolids quality, such as composting, alkaline stabilisation and a number of patented systems.

Many countries have acknowledged that landfill disposal is not a sustainable practice, as they result in greater costs due to transportation over long distances

and the increasing environmental restrictions. These factors, associated with the effect of the stimulation policies for recycling, define a clear trend towards using landfills exclusively for non-recyclable wastes. Gains in energy efficacy are being observed in incineration processes, as well as in energy recovery from anaerobic processes and landfills. Incineration is a growing trend in the European Union (EU) and is decreasing in the United States.

Recycling offers the best future perspective worldwide because it is the most economical and environmentally adequate alternative. This final disposal option must be understood as leading to a good amendment for agricultural lands, when used under sound technical orientation to assure a safe environmental and sanitary solution, as well as a cost effective alternative to improve farmers' income. As the quality and environmental requirements become more and more restrictive, there is a trend of increasing costs for such practices.

Environmental restrictions in the EU are greater than those in the United States, especially regarding metals. Biosolids application is quite often limited by its nitrogen content. In the sensitive zones in the EU, allowable nitrogen application rate has been reduced from 210 kgN/ha·year to 170 kgN/ha·year.

The main factors affecting public acceptance of biosolids are related with odour problems during processing and storage. Alternatives for dewatering, stabilisation and advanced biosolids processing methods have shown significant progress lately, as the regulations are enforced aiming at safe biosolid in terms of metal content and sanitary risks. A successful biosolid-recycling programme is a consequence of providing the involved community with adequate information and transparent results on the environmental monitoring programme.

Table 52.1 shows main biosolid management trends in USA and EU countries.

Adequate planning for sludge final disposal determines several characteristics of the plant itself, from its conceptual design influencing sludge quantity and characteristics, up to unit operations as sludge stabilisation, dewatering, pathogen

Table 52.1. Biosolid management trends in the United States and Europe

Processes		United States		Europe
Sludge production	↑	Increasing	↑	Increasing
More efficient dewatering processes	↑↑	Increasing	↑↑	Increasing
More advanced techniques for pathogen removal	↑	Increasing	↑	Increasing
Sludge recycling	↑	Increasing	↑	Increasing
Landfill disposal	↓	Decreasing	↓	Decreasing
Incineration	↓	Decreasing	↑	Increasing
Ocean disposal	0	Banned	↓	Decreasing
Legal requirements	↑	Increasing	↑	Increasing
Metal concentrations in biosolid	↓	Decreasing	↓	Decreasing
Power efficiency and energy recovery	↑	Increasing	↑	Increasing
Biosolids management outsourcing	↑	Increasing	↑	Increasing
Biosolids management costs	↑	Increasing	↑	Increasing
Social demands related to environmental conditions	↑	Increasing	↑	Increasing
Farmers' demands regarding biosolids quality	↑	Increasing	↑	Increasing

removal, storage and handling. A number of treatment plants are not equipped with the minimum infrastructure needed for such operations due to inadequate planning and require retrofitting to properly operate the produced sludge.

In many developing countries, demands from society and environmental agencies for better environmental quality are being assimilated by public and private water and sanitation companies. Wastewater treatment plants are gradually being implemented in these countries, therefore causing an increase in the sludge production. Some countries have recently issued land application criteria and now require a feasible sludge disposal plan prior to financing and/or licensing the wastewater treatment plant.

52.4 ASPECTS TO BE CONSIDERED PRIOR TO THE ASSESSMENT OF ALTERNATIVES

52.4.1 Relationship between wastewater treatment and sludge management

As shown in Figure 52.1, there is a narrow link among sewage characteristics, type of treatment and generated sludge.

Some wastewater treatment technologies may either minimise sludge production or produce a sludge that is easier to process. Modern wastewater treatment plants must therefore integrate all the sludge cycle, from its generation up to its final destination, not being restricted exclusively to the liquid phase of the sewage treatment. In addition, sludge management must not be restricted to the solid waste generated by the process, but interact and influence the wastewater treatment system definition.

Before carrying out an assessment on the sludge processing alternatives, the following aspects should be considered.

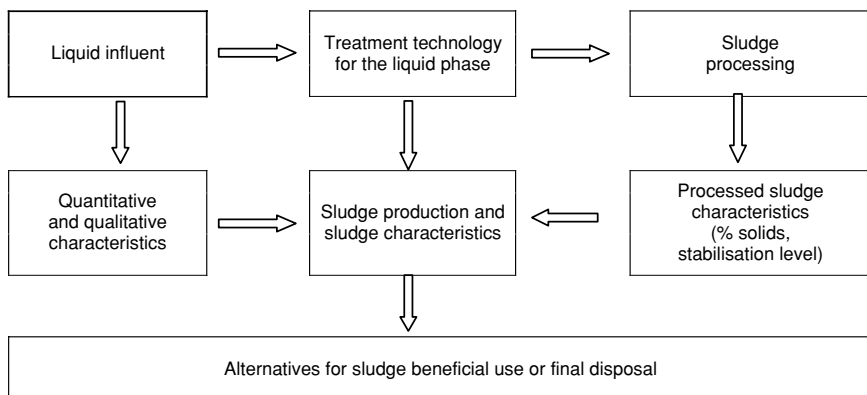

Figure 52.1. Relationship between sewage characteristics, type of treatment, generated sludge and disposal options

52.4.2 Wastewater quality

Metals or organic pollutants contamination may render sewage sludge improper for some uses, such as agricultural recycling. Data regarding sewage contaminants are presented in Chapter 48. Three main possibilities can encompass sewage contamination:

- If the sewage essentially comes from domestic water use, usually no restrictions are imposed towards beneficial sludge uses.
- If the sewage is contaminated with harmful industrial effluents and the sanitation company cannot improve the influent wastewater quality, some sludge beneficial uses (including agricultural recycling) will automatically be discarded if compliance to sludge regulations is not achieved.
- If the sewage is heavily contaminated and the water company is planning to improve its quality, the adaptation to the regulations will demand work with costs and duration varying with the local characteristics.

52.4.3 Wastewater treatment technology

The sludge quality and quantity vary with the wastewater treatment processes as follows:

(a) **Primary sedimentation.** Primary settled sewage sludge is made up of heavier particles with high organic matter content, easily biodegradable and with fast decomposition characteristics, quite often presenting an obnoxious odour. Sludge handling and processing facilities design depend upon sludge volume estimates, which is a function of the characteristics of the raw sewage, including its concentration and age, settling time and characteristics, as well as of the settled solids characteristics, as density and volume, which will depend on tank depth and sludge removal mechanism. The time interval between successive sludge removal operations also influences the sludge volume.

(b) **Chemical precipitation.** Sometimes chemical precipitation is included before or after the biological treatment.

- *Pre-precipitation.* Physical–chemical treatment techniques make up the advanced primary treatment, or chemically enhanced primary treatment. The organic load on the subsequent wastewater treatment stages decreases. However, primary sludge production is increased.
- *Chemical precipitation after biological treatment.* Chemical precipitation after biological treatment improves the quality of the treated effluent, reducing its final organic load and precipitating phosphorus.

Both forms of chemical precipitation significantly increase the sludge volume. Besides, the sludge is unstable and hard to dewater. An increase of 26–35% in sludge mass may be expected when iron or aluminium salts are added to sewage aiming to achieve 1 mg/L of residual phosphorus. Although, theoretically, the sludge increase may be smaller if aluminium sulphate is added instead of ferric

chloride, the aluminium precipitate is harder to thicken and dewater due to bonding of water molecules to the formed floc. The phosphorus removed either by aluminium or iron salts is incorporated in the sludge as nearly insoluble phosphates, which is a disadvantage for agricultural recycling. Depending upon the sludge treatment conditions, struvite (Mg , NH_4 , PO_4) may be formed and incrustations may happen in filter and belt presses. Use of iron and aluminium coagulants should be evaluated in terms of both sewage treatment and sludge processing and handling facilities.

(c) **Biological treatment.** Biological aerobic or anaerobic wastewater treatment is based on the bacterial metabolism action upon the organic matter. Therefore, biomass is formed, originating in the biological sludge, made up of organic and inorganic constituents (see Chapter 47). Biological sludge may be withdrawn at different time intervals, depending on the treatment process, as detailed in Section 5.3. The discharges may be daily, as in activated sludge systems, or at longer time periods, as in upflow anaerobic sludge blanket (UASB) reactors.

Oxygen in aerobic processes acts as an electron acceptor, and the energy yield is higher, leading to a higher biomass production. Conversely, anaerobic systems are able to convert nearly 90% of the treated COD into methane gas, although this energy does not become available for microbial synthesis. As a general consequence, anaerobic systems produce less excess sludge compared to aerobic ones.

Besides these important differences, anaerobic sludges are more stable and easier to dewater than aerobic sludges.

In both cases, only 25 to 40% of the total biomass produced is biodegradable by natural sludge digestion processes, limiting the possibilities of minimisation of sludge production.

Not only the sludge quantities and characteristics need to be evaluated, but also the operational characteristics of the sludge removal system. For instance, designs of stabilisation ponds generally overlook sludge production, because of their large sludge holding capacity. However, in practice, even with cleaning intervals of many years, the sludge removal is a troublesome and costly operation, difficult to be implemented and variable in performance efficiency.

52.4.4 Scale of sludge production

The total amount of the sludge produced at a treatment plant is an important factor in the definition of the sludge processing technique, mainly from an economic point of view.

Sludge dewatering by mechanical devices, for instance, is usually more advantageous than drying beds from a certain sludge production that allows continuous operation. Mechanised processes for sludge processing and disposal are usually more attractive with higher sludge production values. The economic analysis must define the applicability ranges on a case-by-case basis.

52.4.5 Environmental legislation

All alternatives of biosolids recycling, beneficial sludge uses or sludge disposal must comply with the environmental legislation. Treatment and final disposal of the sludge is an activity that needs to be subjected to environmental licensing, and restricting local conditions must be known before a final decision is made on the processing technology and final sludge destination route.

52.4.6 Soils and regional agriculture

Biosolids can only be land applied in agricultural soil when complying with the pre-requisites towards safety assurance for humans, animals and environment. Of course, land application also depends on an economically feasible transportation distance from the sludge generating points to the disposal sites.

A survey on local crops and the pedological scenario must be undertaken, taking into consideration (see also Chapter 53):

- environmental constraints: nearby water sources, housing developments neighbourhood, conservation areas etc
- pedological constraints: ground slope, soil depth, water table level, soil fertility, hydromorphological quality, top soil texture, rockiness and susceptibility to erosion

In addition to the above preliminary data, pathogen removal techniques and marketing strategies for biosolids distribution should also be duly assessed.

52.5 CRITERION FOR SELECTING SLUDGE TREATMENT AND FINAL DISPOSAL ALTERNATIVES

52.5.1 Relationship between sludge processing and the final destination

Type, size and location of the treatment plant are important issues for the selection of the sludge processing and final destination technologies.

(a) Disposal of liquid sludge. When the wastewater treatment plant is close to agricultural areas and the quantity of sludge produced is not very high, dewatering may be omitted from the sludge processing stage, and the sludge may be applied in the liquid form.

(b) Stabilisation. Sludge stabilisation is very important for agronomic recycling, but has moderate significance to other forms of final destination, such as incineration or landfill disposal.

(c) Conditioning. Sludge conditioning through chemicals addition (coagulants and polyelectrolytes) improves solids capture. The selection of the polyelectrolyte and

Table 52.2. Physical state of sludge as a function of solids content

Total solids content (%)	Water content (%)	Physical state
0–10	90–100	Liquid sludge
10–25	75–90	Pasty sludge <ul style="list-style-type: none"> • 14–17% of TS: difficulty in storage in high piles • >18% of TS: storage in stable piles with up to 45° slopes
>25	<75	Solid sludge

Source: CEMAGREF (1990)

its dosage will depend upon the type of sludge to be processed. Thermal treatment, besides facilitating sludge dewatering, also may remove pathogenic organisms.

(d) Dewatering. Sludge dewatering has an important impact on freight and final destination costs, and influences sludge handling, because the moisture content affects the mechanical behaviour of the sludge (see Table 52.2). Some alternatives for final disposal require sludge with a well-defined range of solids concentrations. In municipal solid waste landfills in Europe, sludges lower than 15% in solids content usually are not accepted. On the other hand, some dedicated sludge landfills require at least 40% solids to guarantee mechanical stability of the mass. For thermal drying or incineration, at least 35% of solids are required, although the process efficiency increases with higher concentrations. Ideal solids content for composting, depending upon the bulking agent, is in the range of 15%–20%. Sludges with high solids contents, as those dewatered in drying beds, are not suitable for composting due to excessive dryness, which is further increased when low moisture content bulking agents (as sawdust or tree pruning) are added.

(e) Pathogen removal. Pathogen removal is usually needed for agricultural recycling of sludge, because aerobic and anaerobic digestion is unable to keep pathogens below acceptable densities. Pathogen removal processes can be considered as advanced stabilisation processes, since conventional stabilisation, although efficient for the removal of biodegradable organic matter, is usually insufficient for pathogen removal. More recent stabilisation processes such as the Autothermal Thermophilic Aerobic Digestion (ATAD system) are able to eliminate almost all pathogens in the sludge. Composting is a stabilisation process that is capable of producing a sanitarly safe product. For incineration or sludge disposal in landfills, pathogen removal is not really necessary, whereas if agricultural recycling is being considered, lime treatment, composting, thermal drying and others may be used. Each process has its advantages and disadvantages, and only a local analysis can lead to the best alternative.

(f) Criteria for final disposal. Table 52.3 shows the inter-relationship between sludge processing and its beneficial use or final disposal. There should be no fixed rule for the selection of processing and/or final disposal alternatives, but rather a

Table 52.3. Intervening factors on main alternatives for wastewater beneficial use or final disposal

Parameter	Application on the soil	Disposal in landfills	Incineration	Ocean disposal
<i>Sludge treatment</i>				
– Dewatering	+/-	+	+	–
– Stabilisation	+	+/-	–	–
<i>Sludge volume</i>				
	–	–	+	+
<i>Soil requirements</i>				
– Area availability	+	+	–	–
– Hydrogeology	+	+	–	–
<i>Storage</i>				
	+	+/-	+/-	+
<i>Good practices</i>				
	+	+	+	+
<i>Sludge quality</i>				
– Pathogens	+	–	–	–
– Organic pollutants	+	+/-	+/-	+/-
– Metals	+	+/-	+/-	+/-
– Nutrients	+	–	–	–
<i>Public acceptance</i>				
– Odour, aesthetics	+	+	+	+/-
– Traffic	+	+	+/-	–
<i>Transportation</i>				
	+	+	–	+/-
<i>Energy demand</i>				
	–	–	+	–

+: Important +/-: Moderate importance -: Without importance

Source: Adapted from EPA, cited by Malina (1993)

judicious study on a case-by-case basis to select the best possible alternative in terms of operational and economical aspects.

52.5.2 Operational performance

The confirmation of the performance of the technical alternative under consideration, in a compatible scale with the case under study, is always an important issue. Foreign technologies must be critically analysed, because they are not always applicable to local conditions or may lead to maintenance problems. Emergent techniques shall also be carefully assessed, considering critical points and fitness to local situations. Sludge processing equipment should run free of problems and its technical and operational simplicity is an important aspect.

52.5.3 Flexibility

Flexibility in an important factor, mainly when changes occur in the quantity or quality of the sludge to be processed. In sludge processing, flexibility is assured when several beneficial uses and final destinations are possible, whereas for final sludge disposal, a flexible solution must be able to absorb fluctuations in sludge quantity and quality. Agricultural recycling may absorb quantity variation, but is

Table 52.4. Relevant items in terms of capital costs

Item	Comment
Required area	Areas needed for buildings, equipment facilities, storage and composting yards. Worksheets are helpful for terrain costs evaluation on the treatment plant site or other place
Equipment	All equipment must be included, such as lime mixers, chemicals dosage equipment, composting equipment, aerators, mixers, thermal dryers and others, as they vary with the requirements of each particular case
Handling material	Pumps, belt conveyors, tractors and trucks necessary to convey the sludge at the treatment plant
Buildings	Foundations for equipment installation, sheds, concrete paved or asphalted areas, laboratories, checkrooms etc
Electric installations	Some sludge treatment equipment calls for special electric installations
Miscellaneous	Experience has shown that estimates should consider a "miscellaneous" item, about 20% out of the total for electromechanical equipment and a value around 10% for civil works

Table 52.5. Relevant items in terms of amortisation and operational costs

Item	Comment
Buildings	Usually 5% ($=1/20$) as yearly annual rate along 20 years is considered
Electro-mechanical equipment	Usually values for specific cases are defined, based on other systems in operation. <ul style="list-style-type: none"> • A 14.3% ($=1/7$) yearly rate over capital costs for a 7-year amortisation period may be assumed in some cases • A 20-year lifetime span has been suggested by some sludge dewatering equipment manufacturers • Well-built limestone-storing silos also may have a 15-to-20-year lifetime • Equipment undergoing quick abrasion and frequently used, such as belt conveyors, containers or pumps, may have a lifetime around 5 years, or a yearly amortisation cost of 20% over capital costs
Maintenance	Widely variable item, depending upon equipment itself and operational care. An average 5% yearly value over acquisition cost may be assumed
Energy	Source of power supply and amount to be used should be known. Volumes and unitary costs should be given for liquid or gaseous fuels. Electric consumption is usually expressed in kWh
Material	Must include all chemicals for sludge dewatering and treatment, as coagulants, lime and bulking agent type and quantities
Handling and transportation	This is a heavy cost impact item, variable with solids concentration and chemicals added
Labour costs	Number of employees, personnel qualification, wages and taxes should be specified
Management and control	Should include physical-chemical and microbiological laboratory analysis costs, office furniture and administrative costs. A 6–9% value over operational costs might be adopted in absence of specific values

Table 52.6. Environmental impacts to be considered in sludge management

Item	Comment
Odours	Relevant regarding both treatment and final destination. May be crucial for agricultural recycling or a secondary factor for incineration
Vector attraction	Closely related to odour, it is a major problem in sludge processing and final destination
Noise	It is an important item in urbanised areas
Transportation	Vehicle and route are the most important features to be considered
Sanitary risks	Although difficult to be objectively evaluated, it may be related to the number of people exposed to sludge handling, sludge quality and infection routes
Air contamination	Air can be contaminated by fumes or particulated matter
Soil and subsoil contamination	Extremely variable issue, depending upon the type and method of sludge final disposal
Surface or underground water contamination	One of the major issues of sludge disposal onto soil or landfill. Risk depends on disposal technique and monitoring control
Increased value or depreciation of nearby areas	Acquisition market value may be objectively evaluated in terms of the surrounding areas
Annoyance to affected population	Some solutions, besides affecting people's lives, may generate resistance groups

limited regarding changes in quality. Conversely, incineration can absorb quality variations, being sensitive to quantity fluctuations.

52.5.4 Costs

Costs are a fundamental issue, and may be split into sludge processing costs, transportation costs and final disposal costs. They can be further divided into capital and operational costs. Because cost estimates are a complex task, it might be of help to group them according to their nature, as shown in Tables 52.4 and 52.5 for capital and running costs. Of course, larger systems demand a higher level of complexity.

52.5.5 Environmental impact

Environmental impacts may be positive or negative. The negative impacts can be minimised through adequate operational procedures. The most relevant impacts are shown in Table 52.6, and are also discussed in Chapter 55.

All factors must be evaluated as a function of local conditions, planned technology to be used and reliability of the monitoring system.

52.6 SLUDGE MANAGEMENT AT THE TREATMENT PLANT

(a) Qualitative and quantitative control

Quality and quantity controls are both essential for technical and financial management of the process. Cost per cubic meter or per tonne of disposed sludge should be considered regarding sludge treatment and final disposal activities. Though handling and freight costs are usually based upon moist sludge (cost per m³ of sludge), costs per kg TS (dry basis) are preferred when comparing different alternatives. Therefore, a reliable control of the sludge solids level is a relevant issue. The apparent uniformity in sludge cakes from mechanical dewatering systems conceals some variations that may occur in sludge characteristics, chemical conditioning or anomalies due to mechanical malfunctioning. Sludges dewatered in drying beds have variable final moisture. Chemical quality control for agricultural recycling is mainly concerned with metals (Cd, Ni, Pb, Cr, Hg, Zn, Cu), nutrients (N, P, K, Ca, Mg), fixed and volatile solids. The volatile/total solids ratio is a good parameter to assess sludge stabilisation, and hence potential odours generation and vector attracting capability. Minimum biological quality control parameters recommended for agricultural recycling are faecal coliforms (thermotolerant coliforms) and helminth eggs, including viability tests. Sludge quality controls are needed even for alternatives as sanitary landfills or incineration, although with different frequency and parameters.

(b) Sludge handling within the treatment plant

Processed sludge needs to be transported within the plant premises to a proper storage area, or sent to its final destination. If sludge handling occurs inside the plant yard, belt conveyors or trucks are usually employed.

(c) Storage

Storage within the plant premises must be sized based on the average storage time for the predicted sludge volumes and should consider the mechanical characteristics of the sludge. Sludge with solids content in the 12%–15% range has a pasty behaviour and is unable of support itself on 45° slope piles, thus a larger storage area is needed. Handling within the plant yard is done with front-end truck loaders and tipping trucks. The storage area pavement should be drained and impermeable to avoid underground contamination, as well as to facilitate loading and transport operations. If possible, these areas should be covered, avoiding rain from increasing the sludge moisture and minimising odour problems.

(d) Transportation

Suitable transportation depends upon sludge moisture content. While liquid sludges can be pumped or transported by tank-trucks, pasty and solid sludge can be transported by tipping trucks, quite often used in earth-moving works. Truck

bucket must be water resistant sealed and latched avoiding drops along the route. A plastic canvas should cover the load during transportation.

(e) Final destination monitoring

Final destination monitoring is a fundamental aspect to assure that objectives of treatment and final destination have been fulfilled. Control parameters and monitoring frequency are function of the type of destination and used technology, usually set by regulations from an environmental protection agency.

(f) Managerial system

The managerial system is the link co-ordinating and evaluating all phases, taking care of all necessary measures towards system efficiency. It must assure that samples are correctly collected and sent to the laboratories, and keep record data well organised and easily accessed to allow checking by state inspection agencies as well as for self-improvement evaluations of the system itself. Operational structure complexity should be compatible with the quantity of treated and disposed sludge. Plant workers might be used in case of small daily sludge volumes production, whereas for large systems a specific crew should be assigned to accomplish such tasks. The managerial system plays a key part in any alternative to wastewater sludge processing and final destination. Even when the water and sanitation company outsources the sludge management, it is still responsible for the safety and efficacy of the process, and must exercise a competent control and supervise all significant activities.

Land application of sewage sludge

*C.V. Andreoli, E.S. Pegorini, F. Fernandes,
H.F. dos Santos*

53.1 INTRODUCTION

For thousands of years organic matter has been considered an important soil fertiliser, and organic wastes from human activities were used as fertilisers in ancient times by Chinese, Japanese and Hindus (Kiehl, 1985; Outwater, 1994). In Europe, this became prevalent in 1840 to prevent epidemic outbreaks.

A number of treatment systems during the 19th and 20th centuries have consisted of direct land application of sewage. As technologies for preliminary, primary and secondary biological treatment and chemical precipitation have evolved, sewage land treatment gradually decreased in importance. However, the large increment in sludge production during the 1940s and 1950s, as a consequence of the expansion of sewerage systems, has played an important role in stimulating biosolids recycling whenever possible.

Land application of sewage sludge may be classified into two categories:

- **beneficial use: land application of treated sludge (biosolids)**, when advantage is taken on the fertilising and soil conditioning properties of sewage sludge
- **discard: final sludge disposal**, when soil is used as a substratum for residue decomposition or storage site, without beneficial reuse of sludge residuals

53.2 BENEFICIAL USE

53.2.1 Influence of sludge characteristics on agriculture

From an agronomic point of view, biosolids have nutrients essential to plants, and their presence in the biosolids depend upon the influent sewage quality and wastewater and sludge treatment processes used. Table 53.1 presents biosolid constituents from some wastewater treatment plants in Brazil.

Nitrogen and phosphorus are found in large quantities, whereas Ca and Mg are present in low amounts, except in biosolids treated by alkaline stabilisation. Potassium (K) appears in very low concentration, although in a readily absorbable form by plant roots, being usually supplemented by chemical fertilisers in solids with biosolids addition.

Micro-elements appear in variable quantities in sludges (Table 53.2), usually in higher concentrations for Fe, Cu, Zn and Mn than for B and Mo. When biosolids are applied as the only source of N for plants, the applied quantities of micronutrients often are sufficient for vegetable nutritional needs. It is important to point out that micro-elements are required in small quantities, and if biosolids are applied in larger quantities than crop agricultural needs, toxic effects may occur. Biosolid nutrient concentrations may not supply all plant needs, thus requiring supplemental sources of organic or inorganic fertilisers to cope with the particular crop nutritional needs. The usually supplemented elements are phosphorus – required in large quantities in some soils – and potassium, which has low concentration in biosolids.

Table 53.1. Biosolid constituents from some wastewater treatment plants in Brazil (% of dry matter)

Treatment plant	Type of sludge	N	P	K	Org. C	Ca	Mg	Source
Barueri-SP	Activ. sludge	2.25	1.48	0.01	21.00	7.29		Tsutya (2000)
Franca-SP	Activ. sludge	9.15	1.81	0.35	34.00	2.13		Tsutya (2000)
Belém-PR	Activ. sludge	4.19	3.70	0.36	32.10	1.59	0.60	Sanepar (1997)
UASB-PR	Anaerob. sludge	2.22	0.67	0.95	20.10	0.83	0.30	Sanepar (1997)
Sul-DF	Activ. sludge	5.35	1.70	0.18	34.70	2.68	0.41	Silva <i>et al.</i> (2000)
Eldorado-ES	Anaerob. pond	2.00	0.20	0.04				Muller (1998)
Mata da Serra-ES	Facult. pond	2.00	0.20	0.05				Muller (1998)
Valparaíso-ES	Sediment. pond	4.00	3.50	0.07				Muller (1998)

Table 53.2. Micronutrient contents in some Brazilian wastewater biosolids (ppm)

Treatment plant	Type of sludge	B	Fe	Cu	Zn	Mn	Mo	Source
Barueri (SP)	Activated			703	1,345		23	Tsutya (2000)
Franca (SP)	Activated	118	42,224	98	1,868	242	9	Tsutya (2000)
Belém (PR)	Aerobic			439	864			Sanepar (1997)
UASB (PR)	Anaerobic			89	456			Sanepar (1997)
Sul (DF)	Aerobic	22	20,745	186	1,060	143		Silva <i>et al.</i> (2000)

(a) Nitrogen

Nitrogen is the element with the highest economic value in biosolids, and to which crops present the highest response. Nitrogen comes from the microbial biomass present in sludge and from residues from the wastewater. In the sludge, nitrogen is present in inorganic (mineralised) forms as nitrates and ammonia, and organic forms as proteins, amino acids, amino sugars, starches, associated with polymers, and others.

The organic fraction makes up most of the N in the sludge, ranging from 70% to 90% depending on the type and age of the biosolid. The mineral forms (nitrite, nitrate and ammonia), although representing a small fraction of the total N, are readily available to plants, whereas the organic N must undergo a mineralisation process, slowly changing into mineral forms readily absorbed by plants.

Nitrogen can only be stored in soil in the organic form. Mineral N is an ephemeral element in soil due to its fast absorption by plants. It may also leak underground or escape to the atmosphere through denitrification (Kiehl, 1985).

Equation 53.1 represents, in a simplified way, the amount of N available to the first crop after the sludge application (adapted from Raji, 1998).

$$N_{\text{available}} = f_{\text{org}} (N_{\text{org}}) + f_{\text{vol}}(N_{\text{amon}}) + N_{\text{nit}} \quad (53.1)$$

where:

$N_{\text{available}}$	= N available to the first crop	f_{vol}	= 1 – volatilisation fraction
f_{org}	= sludge mineralisation fraction		of ammonia N in sludge
N_{org}	= organic N of the sludge	N_{amon}	= ammonia N in the sludge
		N_{nit}	= nitrate N in the sludge

The organic N mineralisation rate is highly variable, mainly with temperature, moisture and microbial activity in the soil. A general value for the mineralisation fraction (f_{org}) cannot be defined, as it varies widely from place to place and from one year to another. However, it usually ranges from 20% to 70% of the applied organic N. Likewise, the volatilisation fraction of ammonia N is also variable, mainly due to its exposure to the open air. Those losses can be reduced when the biosolid is incorporated into soil, because most of the volatilised ammonia will be trapped by soil particles, remaining available to plants. A typically adopted value of f_{vol} is 30% of volatilisation. Nitrogen in nitrate and nitrite forms, as already mentioned, although readily available to plants, may be quickly washed away by rainfall.

In this way, the sludge may thoroughly meet N requirements of the crops in one single application, slowly releasing the element into soil together with the utilisation by the plants. Literature reports 30% to 50% N availability during the first year of application, decreasing to 10% to 20% in the second year and 5% to 10% in the third year. The remainder quantity is considered part of the humified organic matter in the soil.

The great solubility of N poses a high contamination hazard to groundwater and that is the main reason why biosolid land application for agricultural purposes is normally limited by the N intake crop capability.

(b) Phosphorus

Phosphorus in sludge comes from residues, microorganism cells formed during wastewater treatment and phosphate-containing detergents and soaps. As shown in Table 53.2, sludge is also rich in phosphorus, with a bioavailability of 40% to 80% of the total P.

Plant requirements of P for vegetative growth and production are very low. However, as many soils have high capacity to fix P, the efficiency of chemical fertilisation becomes very low (only 5% to 30% of total P applied through chemical fertilisers are used by plants), which leads to P being the most applied nutrient through chemical fertilisers in many places. Soil may have high amounts of P (100 to 2,500 kg total P/ha), although the assimilable quantity by plants is extremely low, usually 0.1–1.0 kg/ha, due to the high capacity of fixation by solids (precipitation and adsorption).

Optimisation of P use in agriculture through biosolids can be achieved as follows:

- Biosolids can be seen as a P source, assuring a slow and continued release to plants.
- Biosolids influence P cycle in soil, increasing the availability of mineral fixed P, either through acids from organic matter decomposition, which partially solubilises the fixed mineral P in soil, or by chelating the soil soluble P for later release, or still by coating soil components that fix mineral P.

(c) Soil conditioner

Biosolids may still be used as soil conditioner after lime and/or other alkali addition. Such amendment raises pH, reduces toxic levels of Al and Mn, supplies Ca and Mg, improves the absorption of nutrients and stimulates microbial activity. However, caution is required, mainly in saline soils or in soils where Ca + Mg are highly concentrated, due to possible nutritional imbalance, salinisation and pH rising above 7.0, which may hinder crop growth and productivity.

(d) Organic matter

Biosolid organic matter is an excellent soil conditioner, improving its physical, chemical and biological properties, substantially contributing to plant growth and development. Physical characteristics of soil are improved through cementing action, particles aggregation, soil cohesion and plasticity reduction, and increment in its water retention capability. Organic fertilisation generally improves infiltration

and retention of water, increasing soil stability of aggregates and its resistance to eroding processes.

The addition of organic matter to a fine-textured soil (silty clay, clay or sandy clay) leads to a change in its structure, increasing its friability and porosity, allowing better air and water circulation and root development. In coarse-textured soils (sandy soils), the addition of organic material aggregates soil particles, thus forming earth clods and allowing the retention of larger volumes of water.

Biosolids can still contribute to improve the soil cation exchange capacity (CEC), a reservoir for plant nutritious elements, as well as pH buffering capacity and the microbial activity within the soil.

Table 53.3 summarises properties of stabilised organic matter and their effects on soils.

Table 53.3. General properties of humus and associated effects on soils

Properties	Characteristics	Effect on soil
Colour	Dark coloured in many soils	Facilitates soil warming
Water retention	Organic matter may hold water up to 20 times its weight	Minimises drought effects and seepage losses
Combination with clay minerals	Cements soil particles and forms aggregates	Facilitates water path through soil and gas exchange, and improves stability of soil structure reducing erosion risks
Chelating ability	Stable complexes may be formed with Mn, Cu, Zn and other cations	Fixes heavy metals and increases availability of micronutrients
Solubility in water	Salts and cations associated with organic matter also become insoluble	Limits organic matter loss due to leaching
Buffering effect	Presents buffering capacity	Helps to keep pH stable in soil
Nutrient holding capacity	Varies from 300 to 1,400 Cmol/kg	Increases soil cation exchange capacity (CEC)
Mineralisation	As the organic matter decomposes, nutrients are released to plants	Source of nutrients
Combination with xenobiotics	Influences bioactivity, persistence and biodegradability of pesticides	Poisonous substances become immobilised, and not absorbed by plants
Energy supply	Contains compounds that supply energy to the micro and mesofauna	Stimulates microbial life, increases soil biodiversity, reduces risks of insects and diseases. Antibiotics and certain phenolic acids are produced, fostering plant resistance to insect and pathogen attacks. Enzymes from microorganisms may solubilise nutrients

(e) Productivity

Better responses of biosolids land application are noticed in degraded soils with prior history of structure and fertility problems. Some experiments in the South of Brazil have shown productivity increases around 32% to 54% (Andreoli *et al.*, 2001). These high increases may reflect the low technological level of the agriculture being practised in the selected areas, since the soil in many cases received no fertilisers. High-technological managed crops present less substantial agronomic responses when biosolids are applied, since productivity was not very low prior to biosolids use. However, it is important to notice the significant economy in chemical fertilisers, mainly in nitrogen, as a consequence of biosolids application, besides the medium-term physical, chemical and biological improvements in the soil.

53.2.2 Environmental aspects**(a) Carbon fixation**

The several forms of sludge disposal, be it beneficially applied in agriculture or dumped in a dedicated land disposal site, interfere with the carbon dynamics in our planet.

Carbon on earth is present in several biosphere components, most of it (almost 96%) within oceans and fossil fuels, and only 1.67% in atmosphere. In the last 200 years, anthropic activities considerably reduced biomass carbon, due to deforestation and return to the atmosphere through burning of fossil fuels. From 6 to 8 billion tonnes (Gt) of C released annually into the atmosphere in these processes, 37.5% are transferred to the oceans, and 37.5 to 62.5 Gt are accumulated in the atmosphere (Lashof and Lipar, 1989).

The residence time of CO₂ in soil is approximately 25 to 30 years, and 3 years in the atmosphere. Soils have, therefore, a great potential in the handling of the carbon cycle and, hence, on the greenhouse effect. The estimate for the yearly carbon withdrawal from the atmosphere, considering techniques that increase biomass production in soil, may reach up to 1.23 Gt/year, considering 50% of the soils currently in use.

The influence of the sewage sludge in the retention of organic C in the soil was observed by Melo and Marques (2000) and Melo, Marques and Santiago (1993), with a substantial increase in the organic carbon content and the soil cation exchange capacity. Thus, the agricultural recycling of the sludge, as well as any other form of soil organic matter handling, exploits the direct benefits of productivity increase and the improvement of physical conditions of the soil, and must be stimulated for making up global policies towards carbon cycle balancing.

(b) Erosion and natural resources control

Soil erosion is one of the main environmental problems caused by agriculture, jeopardising the soil productive potential and bringing about large impacts on

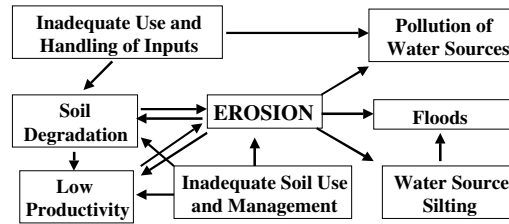

Figure 53.1. Environmental pollution causes and effects in agriculture

the rivers' water quality due to run-off of sediments, nutrients and residues from agricultural toxic products. Figure 53.1 depicts the interaction of the several processes and their interchangeability in terms of cause and effect.

Inadequate use and handling of the soil brings about great damages to soils and rivers. Together with losses due to erosion, most of the agricultural toxic products used in agriculture will end up in the waterbodies. Most of the applied fertilisers are also lost, contributing to the contamination of the water resources.

Strategies for controlling erosion consist in practices for soil handling and use aiming to reduce particles desegregation, increase water infiltration and control surface run-off. The organic matter applied through biosolids furthers a better association of soil particles and improves its structure, stimulates plant root development and the water infiltration through soil layers. It also helps a faster and denser plant growth, quickly covering the top soil, thus reducing raindrop erosion impacts. Table 53.4 lists a number of physical and chemical effects from land application of biosolids and consequences on natural resources conservation.

Table 53.4. Effects of biosolids land use on the control of erosion and environmental pollution

Biosolid	Action in soil	Consequences in the soil	Effects on environment
Organic matter	<ul style="list-style-type: none"> • Aggregation of soil particles • CEC improvement 	<ul style="list-style-type: none"> • Increases water infiltration • Increases resistance against rainfall impact • Reduces nutrient leaching losses • Improves soil fertility 	<ul style="list-style-type: none"> • Reduces surface run-off • Reduces surface water pollution • Reduces nutrients leaching and groundwater contamination
Nutrients	<ul style="list-style-type: none"> • Improvement of soil structure • Plant nourishment 	<ul style="list-style-type: none"> • Fosters plant growth • Increases microbial biomass • Accelerates plant growth 	<ul style="list-style-type: none"> • Increases soil covering • Improves soil aggregation

53.2.3 Sanitation sector

Land application of biosolids represents a good alternative for a serious problem that tends to aggravate in many developing countries. The perspective of increase in sewerage and wastewater treatment levels brings about the related increase in sludge volumes.

Land application of biosolids is seen worldwide as a beneficial solution, because it reduces pressure over natural resources exploitation, diminishes the amount of wastes with environmental disposal constraints (Brown, 1993), allows nutrient recycling, improves soil physical structure and leads to a long-term solution for the sludge disposal problem (Andreoli *et al.*, 1994).

Land application is an alternative that associates low cost with positive environmental impacts, when performed within safe criteria. Nevertheless, it depends on adequate planning based on reliable information on wastewater flow and characteristics, suitable agricultural areas at reasonable distances, and managerial capacity to cope with farmers' demand and proper environmental monitoring. Supply of biosolids must ensure a good product for agriculture, also safeguarding public health and environmental aspects.

53.3 REQUIREMENTS AND ASSOCIATED RISKS

53.3.1 Introduction

The main limitations of biosolids land application are soil contamination by metals and pathogenic organisms, and ground and surface water contamination by phosphorus and nitrogen. A worldwide effort has been noticed during the last several years towards the improvement in sludge quality, aiming to lower chemical and biological contamination through better sewer acceptance criteria and improved wastewater treatment technologies.

Chapter 48 addresses the main contaminants in sludge. In the present section, these are focused in terms of the land application of biosolids.

53.3.2 Biosolid quality

53.3.2.1 *Metals content*

Biosolid metals, when present above certain limits, may be toxic to soil biota, fertilised crops and humans. Since the content of these elements is usually higher in biosolids than in soils, and as their toxicity limits are very low, constant monitoring of the quantities of these elements applied together with the biosolids is required.

The main elements of concern are arsenic (As), cadmium (Cd), copper (Cu), chromium (Cr), mercury (Hg), nickel (Ni), molybdenum (Mo), lead (Pb), selenium (Se), zinc (Zn) and cobalt (Co).

Metal content in biosolids is quite variable (see Section 48.2), depending mainly on the quality of the treated wastewater. Most countries consider heavy metals as

a major limitation to land application of biosolids. The available technological alternatives for removal of these elements from biosolids are incipient and very expensive at the present time. The best alternative to preserve biosolid quality is the preventive control of trade effluents and illicit discharges into public sewerage systems.

Monitoring of the metals content in biosolids is the first step in a control programme, even though the most important issue concerns metals accumulation into soil, as a consequence of successive applications of sewage sludge.

Several countries have issued maximum allowable metals concentrations in soil. However, metal dynamics and their toxicity depends on several local factors, such as original content, soil texture, organic matter characteristics, type of clay, rainfall intensity, pH and cation exchange capacity, among others. Care should be taken when defining a generic value for all types of soils, to avoid relaxation or excessive constraints. The ideal is to define values for each large regional geomorphological unit, thus putting together groups of similar soil and climate.

53.3.2.2 *Pathogenic organisms*

Several disease-causing organisms, including bacteria, viruses, protozoans and helminths, tend to concentrate in the sludge during the treatment process and their quantity reflects the health profile of the sewered population. As pointed out in Section 48.4, they represent a threat to human and animal health, as they can be transmitted through food, surface water, run-off water, and vectors like insects, rodents and birds. To minimise health hazards, biosolids must be submitted to pathogen removal processes to reduce pathogen and indicator densities to values compatible with the applicable legislation and the intended use. Pathogen removal is covered in Chapter 51.

The adopted pathogen removal process affects biosolids management, handling and application. **Alkaline stabilisation** (lime addition), for instance, improves biosolids characteristics, making them suitable to be used as soil amendment. However, the added lime dilutes the nutrients proportionally to the amount added, and leads to a conversion of ammonia nitrogen to free ammonia (NH_3), lost by volatilisation during the maturation period.

Composting may be conducted until the final stabilisation of the biosolid, or be interrupted after the thermophilic phase, in which pathogens have been already eliminated. If undertaken until the final stage, the resulting organic matter will be stabilised and partially converted into humus, producing better effects on soil structure and conditioning. If only the thermophilic phase is reached, the still unripe compost is a good source of nutrients and substrate to the soil biological activity. Similar to limed sludge, it may also act as soil conditioner, after the organic matter has been converted into humus.

Thermal drying is an efficient stabilisation, dewatering and pathogen removal process, involving short-term high temperatures, through which biosolids may reach sterilisation. The resulting material presents low water content, excellent

physical aspect (usually granular) and some nutrient loss (mostly nitrogen) from the original biosolid.

53.3.2.3 Organic pollutants

EPA (1979) identifies 114 polluting organic compounds that are discharged into sewerage systems from domestic or industrial effluents. Some are volatilised during biological treatment, some are effectively reduced by treatment, while others may reach the sludge processing line and contaminate plant biosolids. Organic pollutants are also covered in Section 48.3.

Some highly toxic and persistent organic micro-pollutants that may be found in sludges are (a) aromatic and phenolic hydrocarbons, (b) pesticides, (c) polybrominated biphenyls (PBB) and (d) polychlorinated biphenyls (PCB).

When applied to land with the sewage sludge, they may decompose through solar energy (photo-oxidation) and undergo volatilisation or biodegradation, which may significantly change their structure or toxicity characteristics.

When directly absorbed by plant roots, some organic micro-pollutants are transported through capillary vessels, reaching the plant's aerial parts.

53.3.2.4 Biological stability and vector attraction

Biosolid storage areas and application sites may suffer from vector insects, small rodents and foul odour release. These problems are a consequence of poor stabilisation and high volatile solids content in the final product, which supposedly should have been eliminated through aerobic or anaerobic sludge digestion treatment stages.

Letting those volatile substances to be eliminated during biosolid storage or after its application poses an open invitation to insects and small rodents, which may trigger the biosolid recontamination process, eventually spreading disease vectors.

There are several parameters allowing the assessment of the degree of stability of the organic matter, and odour emission is one of those. The simplest and more direct methods are the determination of the fixed solids contents (ashes) and the reduction of volatile solids from the sludge.

53.3.3 Risks associated with the biosolids application area

53.3.3.1 Preliminaries

Besides biosolid quality, its safe use depends on suitable environmental characteristics of the site to keep contamination risks as low as possible. Application areas should be selected aiming at the best agronomic results, which will essentially depend on soil aptitude for biosolids application, compliance with environmental constraints and crop restriction.

A suitable soil facilitates biosolid incorporation, fosters biological activity and cycling of nutrients, organic matter and other components, with no hazards to human health, environment and soil potential productivity. Major risks of concern are:

- **groundwater contamination** due to leaching of biosolid components, mainly N, associated with the inner soil drainage
- **surface water contamination** due to surface run-off of biosolid components through soil erosion
- **direct contact of biosolids with humans and animals** due to application in areas close to residences or with public access, and inadequate or absent individual protection equipment, amongst others

The soil productive potential may be jeopardised by physical-chemical and nutritional imbalances, mainly related to soil pH and salt concentration. When the pathogen removal process is accomplished through alkaline agents such as lime, soil pH can rise to inadequate levels, disturbing nutrients availability. The frequent use of limed biosolid plus large amounts of Ca and Mg in the soil may cause nutrient imbalance and even soil salinisation.

53.3.3.2 *Soil aptitude*

Soil aptitude for biosolid use must be assessed in terms of the soil behaviour regarding its erodibility, inner drainage capability and difficulties it may offer to mechanised equipment.

Good soil characteristics for land application of biosolids are, according to EPA (1979): depth, high infiltration and percolation capacity, fine texture sufficient to allow high water and nutrient retention, good drainability and aeration, pH from alkaline to neutral (to reduce the mobility and solubility of metals).

Some relevant parameters related to soil aptitude to biosolids are shown in Table 53.5.

A soil aptitude rating system for biosolid application, relating the parameters from Table 53.5 with the associated risk level, is presented in Table 53.6 (Souza *et al.*, 1994). The rating system may help to define site aptitude, both at managerial and planning stages, defining preferential application zones from soil maps.

The aptitude itself is obtained from the most restrictive classification. For instance, a particular soil may be in Class I regarding depth, III regarding texture, III regarding its erosion susceptibility, IV regarding topography, I regarding rockiness, hydromorphism and pH. The final aptitude class of this soil will be IV, because higher risks are related to the land steep slope, high erosion and surface run-off.

The aptitude of the areas according to their classes may be interpreted as follows, as far as the potential for biosolids application is concerned:

- **Class-I soils:** very high potential
- **Class-II soils:** high potential

Table 53.5. Parameters involved in the assessment of soil aptitude for the use of biosolids

Parameter	Importance for the definition of aptitude
Depth	As the soil is a good filter, it hampers leaching of sludge components, reducing groundwater contamination. However, high solubility elements, such as nitrogen and potassium, may travel to deep layers and cause problems. Deep soils show lower risks, because of the higher difficulty in transportation and distribution of sludge and its by-products across soil profile. The minimum distance between top soil surface and rock or water table should be 1.5 m
Texture	Soil texture is related to its filtration capability and percolation easiness through soil profile, which may lead to groundwater contamination. Very permeable sandy soils easily leak sludge components. Conversely, very clayey soils hamper drainage
Erosion	Susceptibility to erosion favours transport of sludge components due to surface run-off. Erodibility potential is assessed by soil topography (shape, slope and slope length) and physical characteristics (texture and aggregation)
Topography	Topographical characteristics influence surface water run-off and particle dragging possibilities. Medium-texture soil on flat land poses no risks for sludge application, whereas a sandy-texture soil on slopes higher than 20% will certainly have erosion problems
Water table	Shallow water tables increase the probability of environmental contamination. Larger soil profiles imply longer contact between sludge elements and soil particles, minimising risks of contaminants leaching. A minimum 1.5 m depth from the soil surface to the water table should always be kept
Drainage and hydromorphism	Poorly-drained soils facilitate anaerobic soil conditions and high moisture, both favourable to pathogens survival and harmful to biological organic matter degradation. Hydromorphic soils, a general term for soils developed under conditions of poor drainage in marshes, swamps, seepage areas or flats present very shallow water tables, which may emerge, contaminating water bodies
Slope	Steep areas are susceptible to erosion due to high run-off speed, which may carry the sludge down to lower areas, polluting water bodies. Slopes should not surpass 20%, and recommended values are around 8%
Structure	Structure concerns how soil particles are organised in aggregates, and influences soil water motion, roots penetration and aeration. Difficulties in water infiltration are associated with sludge transport due to erosion, while lack of aeration lowers sludge degradation rate

- **Class-III soils:** moderate potential, strict practices for soil conservation are advised
- **Class-IV soils:** susceptible to be used, provided that compensating criteria like handling and cultivation practices are considered. Risks must be acknowledged if procedures are not strictly obeyed
- **Class-V soils:** under no circumstances should be used, due to unacceptable environmental risks

Table 53.6. Soil aptitude rating system for biosolids application

Factor	Criteria	Degree	Class
Depth (DT)	Ferralsols (oxisols), nitosols (alfisols), deep cambisols, deep inceptisols or deep acrisols/nitosols (ultisols/alfisols)	0–nil	I
	Cambisols (inceptisols) or acrisols/nitosols (ultisols/alfisols) with low-depth	2–moderate	III
	Lithosols (lithic group) or other units with shallow depth	4–strong	V
Surface texture (ST)	Clayey texture (35 to 60% clay)	0–nil	I
	Very clayey texture (>60% clay) and medium texture (15–35% clay) texture	1–light	II
	Silty texture (<35% clay and <15% sand)	2–moderate	III
	Sandy texture (<15% clay)	3–strong	IV
Susceptibility to erosion (SE)	Soils in flat slope (0–3%)	0–nil	I
	Clayey or very clayey soils in 3 to 8% slope	1–light	II
	Medium or silty texture soils in 3 to 8% slope, and clayey and very clayey-texture soils in 8 to 20% slope	2–moderate	III
	Wavy slope soils with sandy and/or abrupt character texture, or 20% to 45% slope associated with very clayey texture	3–strong	IV
	20% to 45% slope with medium and sandy texture >45% slope or steep slope, independently from its textural class	4–very strong	V
Drainage (DR)	Well-drained soils	0–nil	I
	Strongly drained soils	1–light	I
	Moderately drained soils	2–moderate	III
	Imperfectly and excessively drained soils	3–strong	V
	Poorly and very poorly-drained soils	4–very strong	V
Slope (S)	0–3% slope	0–nil	I
	3–8% slope	1–light	II
	8–20% slope	2–moderate	III
	20–45% slope	3–strong	IV
	Higher than 45% slope	4–very strong	V
Rockiness (R)	Soils with no rocky phase	0–nil	I
	Rockiness citation	2–moderate	IV
	Soils with rocky phase	4–strong	V
Hydromorphic properties (H)	Soils with no indication of hydromorphic properties	0–nil	I
	Soils with indication of hydromorphic properties	2–moderate	III
	Hydromorphic soils: gleysols (aquatic suborders)	3–strong	
pH	Soils with pH lower than 6.5 for limed sludge applications	0–nil	I
	Any pH-range for composted sludge		
	Soils with pH equal to or higher than 6.5 for limed sludge use	4–strong	V

Source: Adapted from Souza *et al.* (1994)

Example 53.1

Define the aptitude class of the following soil: ferralsol with moderate A horizon, clayey texture, evergreen rainforest, lightly-wavy topography.

Solution:

Using the criteria from Table 53.6, the soil aptitude rating system for biosolid application in the following table shows a soil suitable for land application of biosolids.

Criteria	Remarks	Restriction Level	Aptitude Class
Depth	Ferralsols (oxisols) are deep soils, normally with more than 1.5 m.	0–Nil	Class I
Surface texture	Clayey texture does not represent mechanisation difficulties	0–Nil	Class I
Susceptibility to erosion	The association of clay texture in lightly-wavy relief represents low erosion risks in well-managed soils	1–Light	Class II
Drainage	No draining problems (neither excessive nor poor)	0–Nil	Class I
Topography	Lightly-wavy topography, associated with inadequate handling, may lead to erosion	1–Light	Class I
Rockiness	There is no rockiness citation	0–Nil	Class I
Hydromorphism	It has no hydromorphic properties	0–Nil	Class I
Final classification	II ER1 R1 soil with high potential for biosolids use; suitable handling is recommended to avoid possible erosion		

Example 53.2

A region is being assessed in terms of the soil potential for possible land application of biosolids. The soil types, with the respective areas, are listed below. Rate the soils regarding their aptitude for biosolids application.

- **LRd1: Ferralsol (oxisol)** moderate A horizon with clayey texture rainforest evergreen phase lightly-wavy soil – 64,690 ha
- **LEd3: Ferralsol (oxisol)** moderate A horizon medium texture rainforest subevergreen phase lightly-wavy soil and virtually flat – 19,250 ha
- **LEe1: Ferralsol (oxisol)** moderate A horizon clayey texture rainforest subevergreen phase lightly-wavy soil and virtually flat – 18,630 ha
- **BV(a):** Association **Chernosol** (alfisol) shallow clayey stony texture under- evergreen forest phase strongly-wavy relief + **Lithosol** (Litholic subgroup – Entisols) clayey texture subdeciduous rainforest phase strongly-wavy and hilly topography (basic igneous rock substratum) – 62,610 ha

Example 53.2 (Continued)

- **TRe3: Nitosol** (alfisol) moderate A horizon clayey texture subevergreen rainforest lightly-wavy and wavy soil – 188,250 ha
- **PV3: Acrisol (ultisol)** Moderate A horizon sandy/medium texture rainforest subevergreen phase lightly-wavy soil – 6,560 ha

Solution:

The soil rating, based on criteria from Tables 53.5 and 53.6, is as shown in the following table.

Soil	Limiting factors							Class
	DT	ST	SE	DR	S	R	H	
LEe1	0	0	1	0	1	0	0	II SE1 S1
LEd3	0	1	1	0	1	0	0	II SE1 S1
TRe	0	0	2	0	1 and 2	0	0	II SE1 S1 III SE2 S2
PV3	0	1 and 2	2 and 3	0	1	0	0	IV SE3
LRd1	0	0	1	0	1	0	0	II SE1 S1
BV(a)	4	0	3 and 4	0	3 and 4	3 and 4	0	V

Therefore, the preferential zones map should have four aptitude classes: II SE1 S1, II SE1 S1 + III SE2 S2, IV SE3 and V.

Classes I, II and III soils have extremely high, high and moderate aptitude for biosolids application (see the following table). Only 19.21% of the surveyed area is unsuitable for biosolids (IV and V aptitudes), although fruit growing in Class-IV soil could be practised with special precaution as application in ditches.

Agricultural use of biosolids according to soil classes

Class	Soil	Area (ha)	Percentage of area (%)	Recommended use
II SE1 S1	LRd1	64,690	22.24	Suitable for biosolid application
	LEe1	18,630	5.17	
	LEd2	19,250	6.62	
II SE1 S1 III SE2 S2	TRe3	188,250	64.47	
<i>Total apt area</i>		<i>290,820</i>	<i>80.78</i>	
IV SE 3	PV3	6,560	1.82	Not recommended
V	RE10	62,610	17.39	Not allowed
<i>Total improper area</i>		<i>69,170</i>	<i>19.21</i>	
<i>Total area</i>		<i>359,990</i>	<i>100.00</i>	

Table 53.7. Environmental restrictions and rating of lands for biosolids application

Limiting factor	Minimum distance from application area	Soil class
Vicinity of watercourses, canals, ponds, wells, vegetable-producing plots, residential and public visitation areas	100 m	For Class-IV soils
	75 m	For Class-III and II soils
	50 m	For Class-I soils
Water sources for public water supply systems	2,000 m	Area of direct influence on water source*
	200 m	Area of indirect influence on water source**

* Direct influence: semi-circle area with 2,000-m radius upstream from water abstraction point

** Indirect influence area: up to 20 km upstream from water abstraction point

Source: Andreoli *et al.* (1999)

53.3.3.3 Site selection

Biosolid spreading and incorporation should be properly performed, otherwise it may pile onto soil surface and be carried by rainfall run-offs, concentrating in depressions in the area and eventually reaching watercourses. Even if proper pathogen removal has been undertaken during sludge treatment, inadequate biosolid distribution may alter nutrient and organic matter concentrations in water, leading to pollution and contamination.

Biosolid application sites should not be selected near public access places or housing developments to avoid foul odours, vector attraction annoyances and health hazards.

To keep land application of biosolids feasible, a number of countries have established rules, including restrictions for the areas and the crops that may be raised when using biosolids. The limits can be defined according to site soil aptitude, with less or more stringent criterion depending upon specific site characteristics, as shown in Table 53.7. The concern for potential contamination of public water sources is clearly stated, independently from the soil class.

53.4 HANDLING AND MANAGEMENT

53.4.1 Crops, associated risks and scheduling

Besides biosolid quality and site selection for biosolids land application, good agricultural practices are usually ruled by the local environmental agency, and usually include crops suitability, biosolid allowable application rates, application methods and incorporation alternatives. Important items for safe land application and crops suitability are suggested in Table 53.8.

As cereals usually undergo an industrial process before human consumption, they are the most recommended crops to be grown in sludge-amended soils. They can also feed animals or be incorporated into soil to improve its biological, chemical and physical properties (green manure).

Table 53.8. Indicated species and restrictions for cultivation with biosolids

Item	Specification
Recommendation	<ul style="list-style-type: none"> • Extensive agriculture, whose products are industrialised or not consumed <i>in natura</i> • Reforestation and forest management • Fruit growing, in ditches or incorporated prior to yearly blossoming • Grass, application of the lawn with incorporation • Hazardous land reclamation sites, observing maximum allowable accumulation of metals in soil • Dedicated land disposal, in which all detrimental sludge constituents are kept within the site (least desired option)
Restrictions	<ul style="list-style-type: none"> • Should not be used for legumes whose harvested parts have contact with the soil • Not recommended for fish culture • The cultivation of legumes and primary contact crops must not occur within 12 months after application of sewage sludge • Pastures: animals grazing should not be allowed within 2 months after application of sewage sludge
Remark	<ul style="list-style-type: none"> • Sludge submitted to a process to further reduce pathogens (PFRP) can be unrestrictedly used in areas and crops after authorisation granted by the environmental agency

Source: Adapted from Fernandes *et al.* (1999)

Reforestation areas present a special interest, since human consumption is not involved. Also crops such as coffee, sugarcane and tea-crops, which are not eaten raw, represent a potential segment. Metals and excess nitrates reaching groundwater and surface water are usually the limiting factor for a biosolids land application programme.

Fruit growing constitutes a good potential market, due to the high organic matter requirements. High amounts of organic fertilisers are recommended, both in orchard implementation and in yearly holding manuring. Should steep slope hamper the mechanical incorporation of sludge, application may be in ditches during orchard implementation only, keeping biosolid particles from being carried over due to erosion and surface run-off. This restriction must also be observed in coffee plantations.

Higher risk crops are those which have edible plant parts in direct contact with soil (primary contact), mainly legumes and vegetables such as lettuce, cabbage etc., or even below soil surface (carrot, beet, onion, turnip etc.), if they are to be eaten raw.

Animals should not graze on the land for 2 months after application of biosolids as a measure aiming two purposes: (a) to allow a perfect growing of the species in its maximum fodder production and (b) to avoid direct animal contact with the residues.

Nevertheless, if processes for further reduction of pathogens are adopted, these crops may be unrestrictedly fertilised with biosolids.

The above concepts are also relevant for planning purposes. Besides land aptitude, sustained biosolid application still depends on commercial exploitation of the crops in a particular region. The agricultural profile of the focused region is important for both volume assessment of biosolid application and biosolid distribution scheduling all year long, according to the demand of each cropping. A good distribution scheduling has the additional advantage of reducing storage, both in treatment yards and in rural properties. Storage is responsible for many drawbacks, such as odour, insects, physical space requirement, insecure operations and health regulations infringements.

53.4.2 Biosolids application rates

The major agricultural interest in land application of biosolids is associated with its nutrient content, mainly nitrogen, micronutrients and organic matter. Effects of organic matter are felt at long term, increasing soil resistance against erosion, activating microbial life and improving plant resistance against insects and diseases. On the other hand, nutrient effects can be observed at short and medium term. Careful planning is therefore necessary to avoid the application from jeopardising the quality of surface or ground water, as well as the productive potential of the soil.

The control of the application rates, besides being an instrument for controlling fertilisation, is another technical instrument for assessing and controlling the safe use of biosolids. The application rate is a function of the nutrient requirements of the species to be grown, the agronomic quality of the biosolids (mainly N content), the soil of the application site and the biosolids physical–chemical quality (metal content and reactive power).

As the N content in biosolids usually meets cropping needs, application rates are generally calculated as a function of the particular crop nitrogen requirement, whereas P and K are supplemented with chemical fertilisers.

(a) Nutrient recommendation and agronomic quality of the biosolid

The application rate must not lead to an N input greater than the crop requirements to avoid leaching to occur. The amount of N and P in sludge that becomes available through mineralisation of organic matter will depend on previous cropping (nutrients from crop residues) and soil type, and this should be based on a case-by-case assessment. Mineralisation is quicker on sandy soils than on clayey soils. Nitrogen from mineralisation will result in a lower fertiliser requirement. A value of 50% N availability is usually adopted for the first year after biosolid application.

(b) Calcium carbonate equivalence (CCE)

When lime treated sludge is applied, an excessive increase of the soil pH may occur, thus leading to nutrient imbalance.

Neutralisation potential increases with the increase in CCE value, because the acid neutralising potential is associated with calcium carbonate equivalence. One-third of 50% limed sludge (dry basis) is quicklime, which is equivalent

Table 53.9. CCE of some soil amendments used in agriculture

Soil conditioner	Calcium carbonate equivalence (%)
Dolomitic limestone	90–104
Calcitic limestone	75–100
Quicklime	150–175
Slaked lime	120–135
Basic slag	50–70
Gypsum	None

tosaying that when biosolid is land applied at 6 t/ha, a quicklime dose equal to 2 t/ha is also being applied. The quicklime used in the sludge disinfection has a CCE over 150%, whereas limestone, largely used in agriculture, averages a CCE of 75%. Hence, a double amount of dolomitic limestone is needed to achieve the same CCE provided by a given amount of quicklime applied with quick-limed sludge. Table 53.9 presents CCE values of some common soil amendment products.

Most tropical soils have an acidic pH and require liming to increase their productive potential. Limed sludge may effectively substitute limestone application.

Example 53.3

Calculate the biosolid application rate for a medium-productivity corn crop (4,000 to 6,000 kg of grains per hectare). Data:

Soil analysis

pH	Al ⁺⁺⁺	H+Al	Ca+Mg	Ca	Mg	K	CEC	P	C	m% ¹	V% ²	Sand	Silt	Clay
	cmolc/dm ³							mg/dm ³	g/dm ³	%				
4.8	0.2	5.7	5.1	3.6	1.5	0.41	14.2	4	19	3.5	38.8	4	20	76

¹ saturation of toxic aluminium: $m\% = Al^{3+} \times 1,000 / (Ca + Mg + K)$

² saturation of alkalis: $V\% = \text{Sum of Soil Alkalis} / \text{CEC} = (Ca + Mg + K) \times 100 / \text{CEC}$

Aerobic sewage sludge characteristics (% dry matter)

Type	Total N	Total P ₂ O ₅	K ₂ O	Ca	Mg	pH	O.M.	Moisture
Raw	5.00	3.70	0.35	1.60	0.60	5.9	69.4	85%
Limed	3.00	1.8	0.20	9.00	4.80	11.4	37.6	80%

Observation: the table shows the composition of both raw sludge and same sludge after lime addition. It should be noticed that the contents of Ca, Mg and pH are different as the limed biosolids keep their concentrations respectively proportional to the applied liming. N losses following the liming process being carried out are also emphasised. In the table, a lime dosage of 50 % of the sludge dry solids is assumed (1 kg of lime per 2 kg of dry solids).

Example 53.3 (Continued)

Limestone → CCE 75%

Corn plant nutrients requirements

Content in the soil	N	P (mg/dm ³)			K (cmolc/dm ³)		
		0–3	3–6	>6	0–0.15	0.15–0.3	0.3
Productivity (kg grains/ha)		P ₂ O ₅ to be applied (kg/ha)			K ₂ O to be applied (kg/ha)		
<4,000	50	60	40	30	50	40	30
4,000 to 6,000	80	80	60	40	70	50	40
>6,000	100	90	70	50	110	70	50

Source: Andreoli *et al.* (2001)**Solution:***(a) Crop demand*

From soil analysis and nutrient requirements the following fertilising rates are recommended:

- N fertilising requirements: **80 kgN/ha**
- P₂O₅: content in the soil: **4,00 mg/dm³** fertilising requirements: **60 kgP₂O₅/ha**
- K₂O: content in the soil: **0,41 cmolc/dm³** fertilising requirements: **40 kgK₂O/ha**

(b) Amount of available N in biosolid

$$N_{\text{avail}} = 0.5 \times N_{\text{bios}} \quad N_{\text{avail}} = \text{Available nitrogen for the first crop}$$

$$N_{\text{avail}} = 0.5 \times 3.00 \quad N_{\text{bios}} = \text{Total nitrogen in the biosolid}$$

$$N_{\text{avail}} = \mathbf{1.50 \% \text{ dry weight (= 0.015)}}$$

(c) Application rate

The biosolid dose is calculated as a function of N requirements in the crop (80 kg/ha), dividing this value by the available N content in the biosolid:

$$Q_{\text{dry}} = R \cdot F / N_{\text{avail}} \quad Q_{\text{dry}} = \text{amount of applicable biosolid (kg/ha)}$$

$$Q_{\text{dry}} = 80 / 0.0150 \quad R.F. = \text{recommendation of N fertilising (kgN/ha)}$$

$$Q_{\text{dry}} \cong \mathbf{5,300 \text{ kg/ha}}$$

(d) Biosolid applied depending on moisture content

$$Q_{\text{moist}} = Q_{\text{dry}} / (1 - \% \text{ moisture}) \quad Q_{\text{moist}} = \text{wet sludge (kg/ha)}$$

$$Q_{\text{moist}} = 5,300 / (1 - 0.8) \quad \% \text{ moisture} = \text{moisture (water) content of the sludge}$$

$$Q_{\text{moist}} = \mathbf{26,500 \text{ kg/ha}}$$

Example 53.3 (Continued)*(e) Biosolid effect on pH*

To have an estimated effect of limed biosolid on soil pH, total quicklime added together with biosolid must be compared with total lime required to correct soil pH aiming at the planned crop. If the quantity brought by the biosolid is higher, the biosolid application rate should be reduced.

- Checking lime requirement (soil base saturation method – %SB)

$$LR = (V2 - V1) \times CEC \times f/CCE$$

where:

LR = Lime requirement (t/ha)

V2 = SB% (base saturation of CEC) for desired crop production

V1 = SB% of the soil

CEC = Cation Exchange Capacity of the soil

f = incorporation factor (20 cm for biosolids) = 1

CCE = Calcium carbonate equivalent = 120 for quicklime

$$LR = (70 - 38.8) \times 14.2 \times 1/120$$

$$LR \cong 3,700 \text{ kg of quicklime per hectare}$$

- Quicklime added with biosolid:

$$Q_{\text{lime}} = Q_{\text{dry}}/3 \text{ (biosolid composition: 2/3 sludge and 1/3 lime)} \\ = \text{lime at 50\% dry matter)}$$

$$Q_{\text{lime}} = 5,300/3 \cong 1,750 \text{ kg/ha}$$

Soil liming is required.

- Lime supplement required

$$\text{Compl} = LR - Q_{\text{lime}}$$

where:

Compl = Limestone complement needed (kg/ha)

$$\text{Compl} = 3,700 - 1,750$$

$$Q_{\text{dry}} = 1,950 \text{ kg of limestone/ha}$$

- Available limestone required

$$\text{Dose} = \text{Compl} \times CCE_2/CCE_1$$

where:

Dose = Available limestone dose (kg/ha)

CCE₁ = CCE of limestone in biosolids

CCE₂ = CCE of lime required by soil

$$\text{Dose} = 1,950 \times 120/75 = 3,120 \text{ kg ha}$$

Example 53.3 (Continued)*(f) Nutrient supplied and required mineral supplementation*

Nutrients supplied from land application of biosolid (5,300 tonne dry matter)

Nutrient	Content in biosolid (%)	Available content in biosolid (%)	Application rate (kg/ha)	Recommended rate (kg/ha)	Supplement (kg/ha)
N	3.00	1.50	80	80	0
P(P ₂ O ₅)	1.80	0.90	48	60	12
K(K ₂ O)	0.20	0.20	11	40	30

The contribution of the biosolid in the soil fertilising is shown in the graph below.

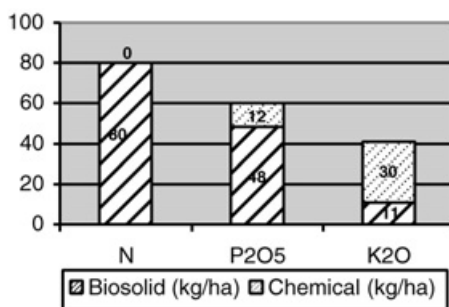

Nutrients in biosolid and in complementary chemical fertiliser

Example 53.4

Check if the biosolid applied dose in the previous example is compatible with the characteristics of the following soil:

Soil analysis

pH	Al ⁺⁺⁺	H+Al	Ca+Mg	Ca	Mg	K	CEC	P	C	m%	V%	Sand	Silt	Clay
	cmolc/dm ³							mg/dm ³	g/dm ³	%				
5.2	0.2	4.7	5.05	3.2	2.26	0.41	9.1	4	19	3.5	60	30	20	50

Solution:*(a) Calculation of the nutrient supply by the biosolid*

From the calculations of the previous example, nutrients were brought by the biosolid at the following doses:

N: 100 kg /ha

P₂O₅: 49 kg/haK₂O: 12 kg/ha

All meet crop requirements, but require supplementation.

Example 53.4 (Continued)**(b) Biosolid effect on pH**

- Checking lime requirement (soil base saturation method – %SB)

$$LR = (V_2 - V_1) \times CEC \times f/CCE$$

where:

LR = Lime requirement (t/ha)

V_2 = SB% (base saturation of CEC) for desired crop production

V_1 = SB% of the soil

CEC = Cation Exchange Capacity of the soil

f = incorporation factor (20 cm for biosolids) = 1

CCE = Calcium Carbonate Equivalent = 120 for quicklime

$$LR = (70 - 60) \times 9.1 \times 1/120$$

$$LR \cong 0.8 \text{ t} = 800 \text{ kg of quicklime per hectare}$$

- Lime added with biosolid:

$$Q_{\text{lime}} = Q_{\text{dry}}/3 \text{ (biosolid composition: 2/3 sludge and 1/3 lime)} \\ = \text{lime at 50\% dry matter)}$$

$$Q_{\text{lime}} = 5,300/3 \cong 1,750 \text{ kg/ha}$$

As $Q_{\text{lime}} > LR$, the application rate shall be corrected.

Soil liming to a pH higher than 6.5 can be detrimental to plant growth, partially because it diminishes essential micronutrients availability.

- Biosolid maximum dose that can be applied:

$$D_{\text{max}} = LR \times 3$$

$$D_{\text{max}} = 800 \times 3$$

$$D_{\text{max}} = 2,400 \text{ kg of sludge (dry basis) per hectare}$$

where:

D_{max} = maximum biosolid dose (kg/ha)

LR = Lime requirement (kg of lime /ha)

(c) Nutrient supplied and required mineral supplementation

Nutrients supplied from land application of biosolid (3,900.00 t dry matter)

Nutrient	Content in biosolid (%)	Available content in biosolid (%)	Application rate (kg/ha)	Recommended rate (kg/ha)	Supplement (kg/ha)
N	3.0	1.5	36	80	44
P(P ₂ O ₅)	1.8	0.9	22	60	38
K(K ₂ O)	0.2	0.2	5	40	35

The biosolid role as complement of nutrient brought by chemical fertiliser is better visualised in the graph that follows.

Example 53.4 (Continued)

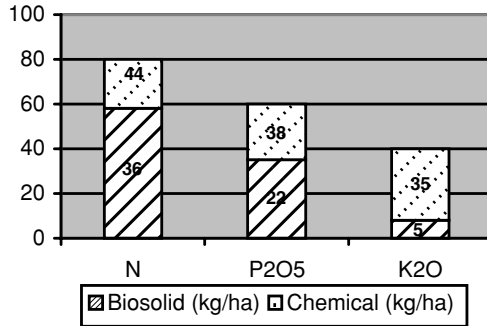

Nutrients in biosolid and in complementary chemical fertiliser

Example 53.5

Evaluate the amount of metal that will be added to the soil from a biosolid land application of 5.55 tonnes (dry matter per hectare), with the following composition:

Sludge characteristics

Element	Content in biosolid (mg/kg – dry basis)
Cd	12
Cu	500
Cr	300
Ni	150
Pb	200
Zn	1,400

Solution:

(a) *Added metal quantities*

$$Q_{\text{metal}} = \text{Bio}_{\text{dry}} \times C_{\text{metal}}$$

where:

Q_{metal} = quantity of applied element (g/ha)

Bio_{dry} = amount of applied biosolid (t dm/ha)

C_{metal} = concentration of the element in the biosolid (mg/kg = g/t)

(b) *Metal concentration increase in soil*

$$C_{\text{soil}} = Q_{\text{metal}} \times 1000 / (d \times 10,000 \times f)$$

Example 53.5 (Continued)

where:

C_{soil} = Metal concentration increase in soil (mg/kg of soil)

Q_{metal} = amount of applied element (g/ha)

d = soil density (kg/m^3) = 1,200

10,000 = area of one hectare (m^2)

f = incorporation depth (m) (in the example, 0.2 m)

Thus, the metal quantity brought by the biosolid is:

Heavy metal accumulation in soil due to biosolid application

Element	Total amount applied (g/ha)	Concentration increase in soil (mg/kg)	Yearly maximum rate (g/ha)		Maximum allowable concentration in soil (mg/kg)	
			EU	USEPA	EU	USEPA
Cd	67	0.03	150	1,900	20	20
Cu	2,750	1.15	12,000	75,000	50–210	770
Cr	1,665	0.69		150,000		1,530
Ni	832	0.34	3,000	21,000	30–112	230
Pb	110	0.05	15,000	15,000	50–300	180
Zn	7,700	3.21	30,000	140,000	150–450	1,460

Discussions on maximum allowable concentrations of metals in agricultural soils have been held for years, whenever biosolids land application programmes are considered. Metal concentrations in soil have a wide range variation. Some soils without biosolids amendment have natural metals concentrations higher than the maximum allowable concentrations in several countries. Well managed biosolid land application programmes are demonstrating that no harm, either to harvested crops or to the environment, are expected if legislation limits and sound operational procedures are followed, since the increase in metals concentrations in soil from biosolid amendment is negligible under such conditions.

53.5 STORAGE, TRANSPORTATION AND APPLICATION OF BIOSOLIDS

53.5.1 Storage of biosolids

After the maturation period, that is, the time needed to complete pathogen removal and comply with legal requirements, biosolid is ready to be transported and land applied.

Biosolids may have a continuous or batch production, and differences may occur as far as production and demand are concerned. Biosolids require maturation periods ranging from zero – in thermal drying processes – to 30–60 days in liming processes. As biosolids are under the responsibility of the sanitation company,

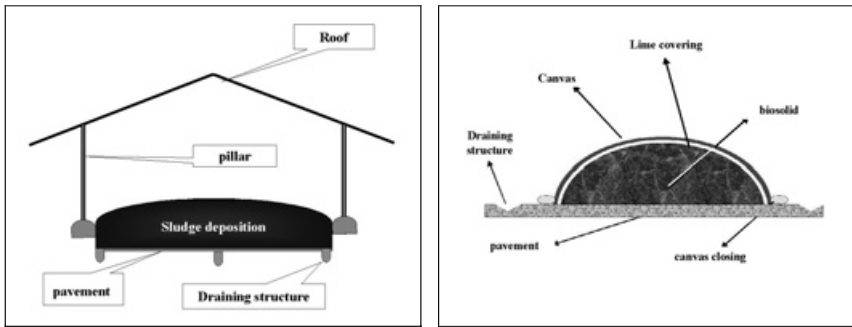

Figure 53.2. Conventional (adapted from Agrodevelopment SA, 1995) and simplified biosolid storage facility

during that period it must remain within the plant premises, and thus a storage yard must be designed and provided for. Figure 53.2 presents a diagram of the basic structure of a conventional and a simplified storage yard.

The storage facility comprises:

- **Paved floor:** pavement is needed to avoid infiltration of leached sludge liquid into the soil. Reinforced concrete or asphalt (pitch) is suitable for that matter. Pitch has higher resistance against chemicals, although less to traffic.
- **Leachate collection network:** leached flow must be redirected to the treatment plant headworks to be treated jointly with the incoming sewage flow, whereas the storm flow (diverted from the storage area perimeter) should join the final effluent disposal.
- **Ceiling height:** no special requirements for canvas covering. It must take into account the operational height of special equipment.
- **Covering:** indispensable for all storage yards. Either a roof or a plastic canvas may be suitable, provided that moisture from rainfall and unauthorised people are both kept away from stored biosolid.

The European Environmental Agency (1997) recommends storage areas of $1.50\text{--}0.80\text{ m}^3$ of biosolid volume per m^2 of storage area for biosolids with mechanical behaviour similar to solids, $0.80\text{--}0.40\text{ m}^3/\text{m}^2$ for somewhat plastic biosolids and less than $0.40\text{ m}^3/\text{m}^2$ for wetter ones.

The equilibrium angle increases with the moisture reduction and determines the maximum height of storage heap without side support.

53.5.2 Transportation

Transportation has a major impact on recycling costs and is directly dependent on sludge moisture content. The higher the moisture, the larger will be volumes to

Table 53.10. Amount of biosolids and number of trips necessary for a 6-tonne (dry matter) application

Type of biosolid	Moisture content (average)	Biosolid cake (tonne)	Number of 12 tonne trucks
Liquid sludge	98%	300	25.0
Thickened sludge	92%	75	6.3
Belt pressed	85%	40	3.3
Centrifuged	70%	20	1.7
Filter pressed	60%	15	1.3
Thermal dried	10%	7	0.6

Table 53.11. Biosolids solids content, transportation and handling

Type of biosolid	Typical solids content (%)	Type of transport
Liquid	1 to 10	Gravity or pumped flow, tanker truck transport
Cake	10 to 30	Tipping truck, leak-proof container
Dry pellets	50 to 90	Conveyor, truck

Source: EPA (1993)

be handled and transported, and therefore, the more troublesome and costly the transportation will be.

For instance, if moisture is reduced from 98% to 85%, the sludge volume becomes only 13% of its original volume, as shown in Table 53.10. As the table also indicates, to keep the application rate of 6 tonnes/ha, 15 to 300 tonnes of cake are needed (from dewatered filter-pressed cakes to liquid sludge), whereas only 7 tonnes are required if granulated thermal dried biosolids are used.

Besides sludge volume, also distance, vehicle type, capacity, road conditions and truck loading operation influence transportation costs. Larger carrying capacities lower the unit transportation cost, but roads and traffic shall be compatible, which is not always the case in tropical rural zones. Table 53.11 lists suitable hauling vehicles, depending upon cake moisture range.

Transportation distance and road conditions influence cost items such as fuel, lubricants and maintenance, whereas biosolid characteristics influence the transportation policy (cleaning costs, rejection to product, concerns for contamination). Thus, transportation distance viability is directly influenced by sludge solids content and transportation policy. Table 53.12 recommends safety measures regarding biosolids transportation.

53.5.3 Application and incorporation

Table 53.13 summarises the main biosolid land application practices in agriculture.

Liquid biosolid application is relatively simple. Drying processes are not necessary, and it may be immediately pumped to the application areas. This method

Table 53.12. Necessary cares in biosolids transportation

Item	Precautions
Volume control of hauled material	Bucket volumetric capacity should not be surpassed and freeboard should be kept to the top of the bucket/wagon side structure
Vehicle surface and tires cleaning	Tires and vehicle surface should be thoroughly washed when leaving treatment plant
Cargo covering	Although covering the sludge with canvas may not be necessary for dried sludge with high solids contents, it is a low-cost operation and may avoid undesirable situations
Safety locks	Safety locks should be verified to avoid accidental openings during sludge transportation. Complete check of all container locks should be carried out within plant yard and before truck loading starts
Use of bulk tractor trucks, bulk trucks or other	The sludge container should be leak-proof and perfectly fitted for sludge transportation
Loading and transportation	Loading should not be allowed during rainy days if there is no weather protection

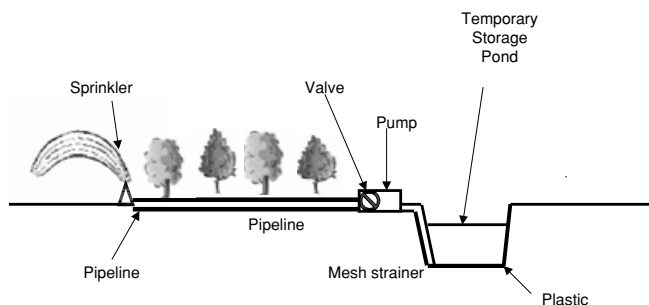

Figure 53.3. Typical sprinkler land application of biosolid (adapted from EPA, 1993)

is generally not used if hauling distance is above 5 km, due to larger liquid sludge volumes involved and implied associated costs. Figure 53.3 shows a sprinkler land application of biosolid.

Dry biosolid may be land applied with equipment used for animal manure application. Depending upon moisture content, pathogen-removed biosolids may vary from pasty (less than 25% solids) to solid (over 50% solids) consistency. Heat dried biosolids with 45 to 65% solids (55 to 35% moisture) have a tendency to stick, as well as 15–35% solids belt-pressed cakes (85–75% moisture), requiring more robust and powerful equipment for spreading.

Heat-dried granular biosolid, typically with 2–4 mm diameter, 90% solids and higher, may be handled, spread and land-applied using classical farming equipment, such as spreaders for lime, damp lime, fertiliser, poultry litter, bedding,

Table 53.13. Summary of main biosolid land application practices in agriculture

Application	Method	Description	Advantages	Disadvantages
Surface application of liquid biosolid	Spray irrigation	Pre-treated liquid biosolids are directly piped and pumped to sprinklers	Traffic in area is minimised Application is feasible on unprepared land	Pond storage or tank storage is needed High storage volume Foul odours during storage and application Sludge adhering to the foliage
	Hauler tank spreading	Liquid biosolid is either injected into soil or sprayed	Haul trucks transport and apply biosolid Smaller applied volumes	Foul odours Site slope limits application Soil may become excessively compacted Depends upon ideal climate and soil conditions
Surface application of solid or semisolid biosolid	Farm tractor and wagon spreading	Biosolid is transferred to farming equipment for application	Usual farming equipment	Foul odours during and after spreading Pond storage or tank storage is needed
	Dewatered sludge haul truck spreader	Solid or semisolid biosolids are transported and spread by trucks	Haul trucks transport and apply biosolid Eliminates odour problems	Solid or semisolid biosolids Unusual equipment in many places Soil may become excessively compacted Depends upon ideal climate and soil conditions
	Tractor powered box spreader	Dewatered biosolid is loaded into the spreading wagon and applied	Usual farming equipment Eliminates odour problems Reduces soil compaction problems	Solid or semisolid biosolid. Depends upon ideal climate and soil conditions
Sub-surface application of liquid biosolid	Tank truck or tractor with a chisel tool	Liquid biosolid is unloaded from tanker and loaded into the vehicle. A subsoil mixing plough is coupled to the vehicle. The biosolid is pumped into the subsoil through hoses coupled to the shafts of the subsoil mixing plough	Minimises odour problems and vector attraction Spreads and incorporates the sludge in a single operation	Unusual equipment in many places Huge volumes to be transported Need for storage pond Site slope limits application

Source: Adapted from U.S. EPA (1993)

compost, gypsum, sand, salt, cement, fly ash and any bulk material. The same equipment is suitable to apply sludge cakes from drying beds after lump breaking of an otherwise sticky sludge (about 50% solids).

Incorporation is a desirable practice and is recommended in a number of biosolid land application regulations. Incorporation avoids people and animals' direct contact with the biosolid and minimises risks of surface water contamination. Biosolid soil incorporation may be performed with classical farming equipment usually found in almost any rural property as disc plough, moldboard plough, disk tiller and chisel plough. Liquid digested or undigested sludge may be soil injected at the pre-determined application rate, 150–300 mm below the ground surface by a purpose-built tractor or truck, which breaks the ground surface and injects the biosolid, resealing the surface afterwards with special press wheels (Santos, 1979).

Regardless of the equipment used, an undesirable soil compaction may occur under the tire tracks which should be dealt with by farmers.

Correct equipment operation is even more relevant than the equipment itself. Ploughs and chisel ploughs promote deeper incorporation of biosolids into the soil, and should not be used unless the soil needs initial preparation. Disc tiller achieves incorporation at 10–15 cm depths, which is sufficient if basic soil preparation was performed before biosolid spreading.

53.6 OPERATIONAL ASPECTS OF BIOSOLID LAND APPLICATION

53.6.1 Introduction

The previous topics dealt with concepts, processes and methodologies required for the beneficial land application of biosolids. This information should be duly assessed and structured to provide a framework for planning activities, organisation, implementation and management of a recycling programme.

The planning process of any biosolid disposal alternative should start with data collection and assessment aiming to properly characterise the biosolids and the wastewater treatment system. This initial information should be compared to the applicable legal regulations for a preliminary evaluation of the feasibility of the intended application.

The following stages will involve public acceptance surveys and studies of quality and availability of future application site, means of transportation, climatic conditions, among others. Figure 53.4 shows schematically the main planning phases.

53.6.2 Preliminary planning

Preliminary planning performs an appraisal of legal and technical feasibility issues related to specific biosolid land application and systemises all pertinent information that will be needed to make the intended programme operational.

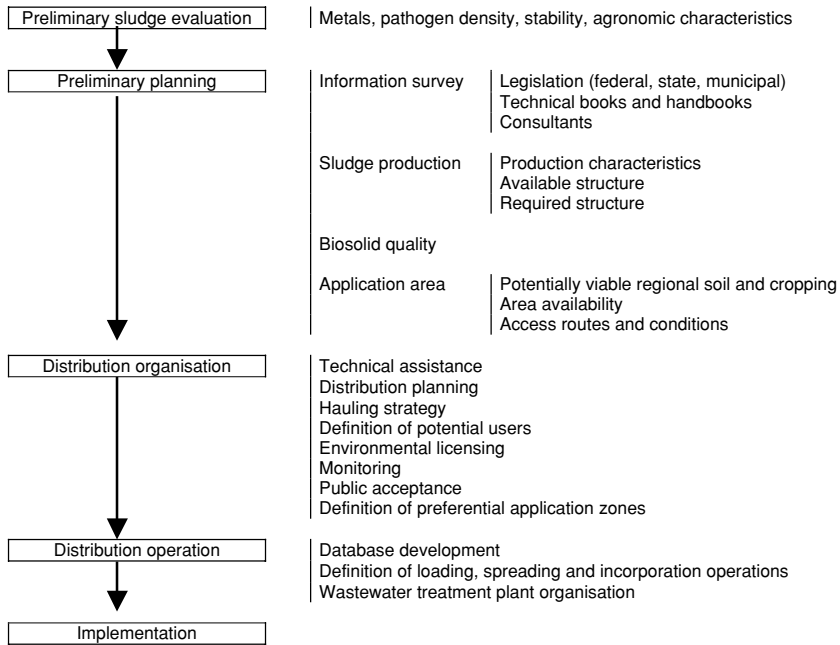

Figure 53.4. Planning of a feasibility study for land application of biosolids

53.6.2.1 Preliminary survey

All current publications covering local legislation and technical papers must be gathered and compiled with the help of skilled practitioners. The information gathered in this phase is fundamental for project development, mainly regarding legal restrictions.

53.6.2.2 Biosolids production

A report should be produced, describing in detail the wastewater treatment plants involved, covering the following items:

- *description of the treatment process* (from the inlet to the treatment plant to the sludge dewatering and final disposal, including all types of produced solids)
- *working regime* (continuous production, mixed or in batches)
- *system capacity* (design capacity, present incoming flow and potential increases)
- *available sludge handling facilities* (dewatering system, pathogen-removal system, transport/loading vehicles, laboratory, storage area, ancillary equipment, chemicals involved etc.)

- *biosolids production characteristics* (current and design volumes and physical-chemical and microbiological quality, aiming future forecasts compatible with planned sewerage system expansions)
- *available area* (sizing of existent and required area for present and future facilities, including pathogen-removal system and storage yard)
- *required area for biosolid land application and suitability of regional crops* (preliminary estimate may use Equation 53.2)

Required area (ha)

$$= \frac{\text{Biosolids production (tonnes dry solids)}}{\text{Average application rate (tonnes dry solids/ha per year)}} \quad (53.2)$$

Based upon the above information, long-term planning involving material and financial resources and required area arrangements can be done and implementation guidelines may be issued.

Example 53.6

From Example 47.1 (Chapter 47), estimate the agricultural area needed for land application of dewatered biosolids from the UASB reactors. Assume an average application rate of 6 tonnes of sludge dry matter per hectare (not considering potential environmental limitations, such as metal accumulation, N leaching, pathogens dissemination).

Data: sludge production calculated in Example 47.1: 1,500 kg of SS (dry matter)/day, for a 100,000-inhabitant population served by the system.

Solution

Considering an average 6-tonne application (=6,000 kg) of dry matter per hectare, and using Equation 53.2), the following area is needed:

$$\text{Required area} = (1,500 \text{ tonnes/d}) / (6,000 \text{ tonnes/ha}) = 0.25 \text{ hectares/day}$$

Example 53.7

The biosolid discharge from Example 53.6 (UASB-reactor dewatered sludge) occurs in monthly batches. Calculate the monthly area necessary for agricultural land application of the sludge.

Solution

$$\begin{aligned} \text{Monthly biosolids production} &= (1,500 \text{ kgSS/d}) \times (30 \text{ d/month}) \\ &= 45,000 \text{ kgSS/month} \end{aligned}$$

$$\text{Required area} = (45,000 \text{ kgSS/month}) / (6,000 \text{ kg/ha}) = 7.5 \text{ hectares/month}$$

Example 53.8

Estimate the area required for the land application of the sludge produced per inhabitant served by the sewage treatment processes listed in Table 47.1 (Chapter 47). Remarks:

- Within the ranges presented in the table for per-capita sludge-mass daily production (kgSS/inhabitant-d), adopt the average values
- Assume application rate of 6 ton SS/ha (not considering potential environmental limitations, such as metal accumulation, N leaching, pathogens dissemination)

Solution

Using Equation 53.2 and the average per-capita SS production data from Table 47.1, the following table and graph may be produced.

Daily sludge production and required area for biosolids recycling, for various wastewater treatment systems

Systems	Sludge production (gSS/inhabitant-d)	Yearly sludge mass produced by 1,000 inhabitants (tonnes SS/year)	Agricultural area needed for disposal (ha/1,000 inhabitants-year)
Primary treatment (conventional)	40	14.6	2.4
Primary treatment (septic tanks)	25	9.1	1.5
Facultative pond	23	8.4	1.4
Anaerobic pond – facultative pond	41	15.0	2.5
Facultative aerated lagoon	11	4.0	0.7
Complete-mix aerated lagoon – sediment pond	12	4.4	0.7
Conventional activated sludge	70	25.6	4.3
Activated sludge – extended aeration	43	15.7	2.6
High-rate trickling filter	65	23.7	4.0
Submerged aerated biofilter	70	25.6	4.3
UASB reactor	15	5.5	0.9
UASB + aerobic post-treatment	26	9.5	1.6

Note: biosolid application rate = 6 tonnes SS/ha

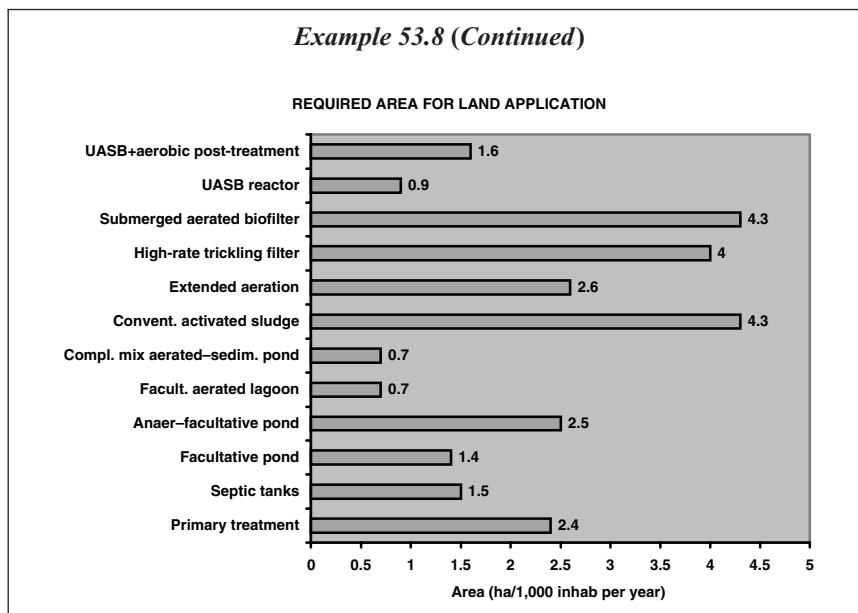

53.6.2.3 Biosolid quality

The continuous evaluation of the physical–chemical and microbiological characteristics of the biosolid, encompassing pathogen dissemination risks and soil metals accumulation, is indispensable to assess the feasibility of land application. The parameters to be evaluated must be those whose control is specified in the particular local legislation. Indispensable parameters are:

- *agronomic parameters*: N, P, K, Ca, Mg, S, C/N, pH, C
- *metals*: Cd, Cr, Cu, Zn, Pb, Ni, Hg
- *pathogen density*: viable helminths eggs, faecal (thermotolerant) coliforms
- *stability*: ash content

53.6.2.4 Application area

Application area assessment implies using all information gathered previously, including the biosolid production data, as well as regional land uses and soil characteristics, environmental restrictions and socio-economic local context.

(a) Source of information

Relevant data on land uses, regional crops and management practices can be obtained from agricultural state and municipal departments. Several such data are available on the Internet.

It is indispensable to contact the local environmental agency, for information gathering on regional environmental issues and ecological zoning. The identification of existing public water supply sources and protected watersheds is also essential for a sound biosolid management planning.

(b) Use of the soil and availability for biosolids use

Present and future land uses are always a significant issue for proper selection and definition of application areas.

Current use

The evaluation of the current use basically follows the guidelines mentioned earlier in this chapter. The municipal departments of agriculture must keep records of all relevant information regarding agriculture, reforestation, mining and other potential disposal sites, and may provide the interested party with pertinent maps, aerial photographs and satellite images of the particular region under study.

- **Farming.** Some farming practices such as small properties in a non-agricultural neighbourhood or traditional vegetable-growing communities may render unfeasible an application biosolids programme. Convenient places cultivate a wide variety of crops, from cereals to pasture and fruit growing, which facilitates the scheduling of the biosolid land application all year round.
- **Reforestation.** The cultivated forests can use high amounts of biosolids in a single application, since they are kept for long periods, thus representing a very important potential market.
- **Reclamation areas.** Degraded lands are found everywhere and some may be beneficially reclaimed with wastewater biosolids. The application load must consider future uses of the area, for instance, disturbed areas such as strip-mine sites are generally designed for a one-time application of biosolids based on metal loading limits. A single large application in such cases can provide organic matter and nutrients required to support establishment of a mixture of plants.
- **Landscape gardening.** Biosolids land application in public areas is a usual practice in developed countries and still infrequent in many developing countries. When contact with population is expected, biosolids pathogen-removal and stability processes must be stricter and demand careful observation. Private gardens can also benefit from biosolids application once careful criteria are followed.
- **Substrate.** Biosolids may replace the organic matter usually applied for substrate make up in soil cultivation, cuttings and flowers or organomineral fertilisers.

Future use

Future biosolid land application planning must consider preferential application zones, mainly if application sites are near densely populated areas. Those sites

Table 53.14. Climate impacts on biosolid application

Impact/Climate	Warm/Dry	Warm/Humid	Cold/Humid
Operation timing	All year round	Seasonal	Seasonal
Storage requirement	Low	High	High
Soil salinisation risk	High	Low	Moderate
Leaching potential	Low	High	Moderate
Erosion run-off risk	Low	High	High

Source: Adapted from EPA (1993)

demand more frequent monitoring, especially to avoid aesthetic problems and diminish direct or indirect contamination risks for the population. Information on those matters may have a long-term influence upon the feasibility of future application programmes.

(c) Access

Areas far away from the wastewater treatment plant or with poor access roads conditions are a major influence in the definition of preferential spreading zones.

(d) Land aptitude

Soil aptitude may be evaluated with the methodology proposed in the application example, as previously described in this chapter (see *Soil Aptitude*).

(e) Climatic features

Climatic features, also covered previously in *Soil Aptitude* in this chapter, concern application timing, soil salinization and leaching, and biosolids natural dewatering difficulties. Table 53.14 presents potential impacts of climatic changes when biosolids are land applied.

(f) Socio-economic context

In this phase definitions are required on:

- what is the regional agricultural profile and what problems may arise regarding public acceptance of the new technology
- whether regional farming equipment will be compatible with the planned work (that is, tractors, solid or liquid waste spreading devices, trucks, type of hauling practised, etc.)

53.6.3 Distribution planning

Once all pertinent data on local biosolids characteristics and volume are gathered and after knowing the pertinent agricultural regional profile, biosolid distribution may be conveniently planned and organised. Should any technical unfeasibility be detected without a perspective of acceptable solution, including legal and

environmental constraints, a different wastewater sludge disposal alternative should be considered at this time.

(a) Biosolid disposal alternatives

Preliminary survey and studies on wastewater sludge disposal alternatives are expected to point out which alternatives deserve further planning. Only those complying with technical, economical, environmental and legal constraints deserve deeper consideration analysis.

Sludge production and dewatering are in-plant operations. New wastewater plant designs should consider sludge disposal alternatives, since the design of the sludge handling facilities should be consistent with the required biosolid quality, mainly, if agricultural use is involved. This is particularly true regarding the selection of the pathogen-removal process, which shall be dependent on the desired final quality and influence the entire sludge handling operation:

- better quality biosolids may eventually be used in any crop, if complying with environmental control rules
- biosolids with higher pathogen densities have crop suitability limitations, especially those that are eaten raw or whose edible parts have direct contact with the biosolid fertilised soil

According to USEPA, biosolid pathogen-removal processes may be classified into Processes to Further Reduce Pathogens (PFRP) or Processes to Significantly Reduce Pathogens (PSRP). PFRP biosolids have excellent quality and do not have any crop restriction, whereas PSRP quality imply pathogen reduction down to adequate levels, and the biosolid should comply with stricter criteria. Pathogen removal should also influence biosolid agronomic characteristics, as mentioned earlier in this chapter.

Equipment acquisition, storage and maturation area or facilities, hauling and application techniques are all dependent on the definition of the pathogen-removal system.

(b) Treatment plant structure

Once it is established how the sludge will be treated and handled, the next step is either to organise the treatment plant to accomplish the task, or to retrofit the existent facilities. Aspects that need to be taken into account are:

- equipment and labour requirements
- storage requirements
- cleaning of hauling vehicle
- supervision at the treatment plant
- transportation

(c) Public acceptance

The beneficial use of biosolids, especially its agriculture recycling, is a worldwide practice, certainly representing a very good alternative for wastewater sludge disposal, provided that due care is taken. However, it will only be feasible if supported

by public acceptance, which is directly dependent upon public credibility on the safe use of the product.

The community participation must be considered as important as any technical design consideration, and the delay in the public participation may crystallise negative concepts that will hardly be overcome. Public involvement significantly diminishes the opposition to the programme. The goals of a public participation programme are:

- To increase awareness of technicians, scientists, users and consumers on advantages and precautions to be observed when beneficial uses of biosolids are considered
- To increase consciousness of the affected population about all process stages, stressing measures taken to assure that biosolid quality will not jeopardise public health
- To ask technicians, community leaders and politicians opinions and suggestions
- To assure public access on biosolid quality control results and impacts regarding areas fertilised with biosolids

Public education and interactivity are a major help to attain such goals. The educational programme must impartially approach advantages and disadvantages of biosolids use. Topics to be presented are:

- reasons for recycling option among other sludge disposal alternatives, such as incineration and landfills
- measures taken assuring that biosolid production, handling and application are safe operations
- crop and soil restrictions
- costs involved
- project advantages considering the economical benefits to farmers
- project advantages considering environmental improvement
- comprehensive description of the whole process, from biosolid generation up to its land application

The key to a successful interactivity lies on a direct and open communication channel between the involved community and the project technicians.

Marketing strategies should consider how to overcome the absence of correct knowledge on benefits and potential risks regarding biosolids land application. Prejudice against land application of the sludge is a common position, which makes marketing very important since the beginning of the project.

(d) Technical assistance

Agronomic assistance is an essential tool for a successful biosolid land application programme. The agronomic engineer or a specialised contractor should be responsible for the selection of the properties in which the biosolids will be applied and for technical advising on biosolids use. It is important to keep in mind the primary responsibility of the sanitation company regarding any problems that

Table 53.15. Alternatives for agronomic assistance

Strategy	Company	Advantages	Disadvantages
Association	State agency providing agricultural technical assistance	Credibility with the producer Multi- disciplinary technical support Local offices in almost every municipality Training ease Experience in technology spreading Regional knowledge Willingness to work with small producers	Bureaucracy Difficulty to achieve a profitable relationship with large producers
Business transactions	Private company providing agriculture technical assistance	Training easiness Contact with the local rural area Experience and interest in technology spreading Easiness to achieve a profitable relationship with large growers	Starting of a novel activity Restrict technical staff Lack of homogeneity from technicians from different municipalities Cost
	Specifically assigned professional to do the work	The own company rules the technical assistance Consistent selection criteria	Cost
Records	Autonomous professionals	Payment per area, number of prescriptions or biosolids applied volume	Lack of homogeneity in staff Lack of standardisation in information and reports

may eventually happen regarding this alternative of sludge disposal. Table 53.15 shows strategic alternatives, advantages and disadvantages of technical agronomic assistance programmes to farmers.

(e) Monitoring

Monitoring is an indispensable tool to assess whether positive or negative impacts are occurring from the current biosolids land application process. It helps maximise positive impacts and propose control measures for the negative ones. The monitoring programme must generate sufficient data to make biosolid recycling an environmentally and socially suitable operation in full compliance with legal parameters. Monitoring is covered in more detail in Chapter 55.

(f) Environmental licensing

The environmental operational license to start-up the wastewater treatment plant must be given only when the wastewater sludge disposal option has been approved by the local environmental agency. Usually, the sanitation company is required to

file a complete set of documents encompassing the biosolids disposal plan: sludge production flowsheet, dewatering, pathogen removal and handling, plus quality control and monitoring routines.

53.6.4 Distribution operation

The last planning phase covers the arrangements for implementing the activity involving staff selection and training, control programme adjustments, report and data record systems:

- **Selection and training of technical staff.** All operational and managerial personnel must be hired and trained in full compliance with the legislation and the environmental agencies requirements.
- **Control programme.** The control programme is a map of the recycling activity, where each programme stage is clearly represented, including risk maps with detailed contingency measures to be taken should an emergency happen.
- **Report and data record system.** Reports on the biosolid land application must be submitted to environmental agencies, showing monitoring results. The area utilisation history is built up and may be available for public consultation, amplifying reliance on competence of the responsible staff in charge of the sludge disposal. Those reports are usually filed for some years and encompass sludge treatment, pathogen removal, biosolids handling and land application. The producer is always responsible for the environmental effects of his waste. All areas where sludge has been applied should be registered, with control numbers for the particular biosolid lots handled, as well as their characterisation. Table 53.16 shows information to be registered and reported.

53.7 LANDFARMING

53.7.1 Preliminaries

In the sludge land disposal and treatment system known as *landfarming*, there is no productive use of sludge nutrients and organic matter. The process goal is the sludge biodegradation by soil microorganisms present in the tillable profile, while metals are held on top soil surface layers.

Soil supports microorganisms and oxidation reactions of the organic matter. As the area dedicated to landfarming does not aim at any crop cultivation, rates applied are much higher than those with agronomic purposes. Nevertheless, a number of environmental concerns are valid for both landfarming and agriculture, although with different limits since landfarming is associated with greater technological interventions to control environmental pollution.

Technically, it is feasible to promote compaction and impermeability of the soil layer down to a depth of 60–70 cm from the surface, to build a proper drainage

Table 53.16. Data recording and reporting

Activity	Information	Technician responsible		Information that must be reported
		Production	Assistance	
Biosolid production	Environmental permits for biosolid land application	✓		✓
	Distribution plan	✓		
	Metal content	✓		✓
	Pathogen density	✓		✓
	Biological stability	✓		✓
	Description of stabilisation and pathogen removal	✓		
	Biosolids quantity allowed to leave treatment plant	✓		✓
	Hauling records	✓		
	Responsibility Statement (signed by user)	✓		
Land application	Application site selection		✓	✓
	Area size		✓	✓
	Application date		✓	✓
	Amount of applied sludge		✓	✓
	Area description and aptitude records		✓	✓
	Handling practices and description records		✓	✓
	Soil pollutant accumulation records		✓	✓

system, and to collect and treat all percolates. Sludge application rates may then increase because nitrates subsoil contamination is being prevented. If these techniques are not applied, a greater groundwater quality control is necessary and sludge application rates would be lesser.

As the land farming soil is continuously revolved to provide aeration, vegetation usually does not grow in such sites, although some landfarming areas have species with the sole purpose to fix nutrients and increase evapotranspiration.

53.7.2 Basic concepts

Since the process objective is organic waste biodegradation on top soil, the pertinent parameters to define process efficiency are temperature, rainfall, soil pH, aeration, nutrient balance, soil physical state and sludge characteristics.

Due to the high sludge application rates lasting for several years, the main environmental concerns are related with the possible contamination of waters (both underground and surface). Therefore, an efficient and well-maintained surface drainage system should be provided from the beginning of the operation. Other negative environmental impacts like odours and undesirable attraction of vectors may occur. Figure 53.5 shows a cross-section of a landfarming cell.

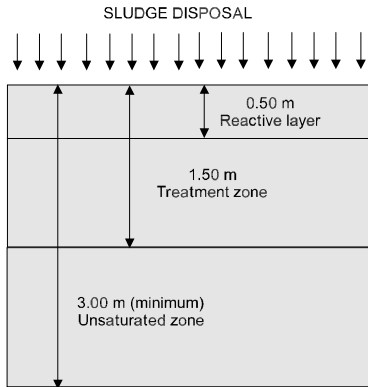

Figure 53.5. Schematic cross-section of a landfarming cell

In the reactive layer, the sludge bio-oxidation reactions occur through intense microbial activity during the biodegradation process. Periodically, it must be tilled to promote aeration and then harrowed levelled.

The ‘treatment zone’ is unsaturated by definition and should have no more than 1.50 m depth. This is where released components from biodegradation are fixed and transformed.

Water table should be at least 3.0 m deep during the wet weather season. Water table depths of 10–20 m are not unusual and are the ideal situation for process implementation. The deeper the water table, the safer will be the area.

The sludge application rate will be a function of the soil biodegradation capacity, which, as mentioned, depends on several factors. Organic matter biodegradation rate may be estimated by Bartha’s respirometric test. If organic matter biodegradation rate is known, waste treatability can be evaluated and best handling conditions may be selected, such as application rate, soil pH correction, ideal soil moisture and nutrient balancing.

The wastewater sludge to be tested shall be previously characterised with acute toxicity tests (if required by the environmental agency), fixed and volatile total solids, moisture content, organic carbon, nitrogen, phosphorus, heavy metals, oil and greases.

53.7.3 Selection of areas for landfarming

Most criteria given to select suitable biosolids land application sites for agricultural purposes are also pertinent to choose landfarming sites, with some particular considerations. According to EPA 625/1-83-016 (EPA, 1983), the following aspects must be considered during site selection for landfarming:

- distance of the area from the sludge production site
- condition of the transport roads

Table 53.17. Landfarming site selection criteria: main USEPA parameters

Parameter	Unacceptable	Desired
Slope	> 12%	< 3%
Soil permeability	> 1×10^{-5} cm/s for soil layers less than 0.6m deep	$\leq 1 \times 10^{-7}$ cm/s for soil layers deeper than 3.0 m
Distance from surface waters	< 90 m	> 300 m > 60 m for intermittent streams
Water table depth	< 3 m	> 15 m
Distance from drinking wells	< 300 m	> 600 m

- existence of an impermeable geological barrier, rocky-layer type, avoiding fracture zones
- absence of nearby aquifers
- transition distance between the selected site and populated areas, public interest sites or wells
- distance from water courses
- suitability of the topography
- climate conditions favouring high evaporation and transpiration rates
- well-drained soils, high cation exchange capacity and pH above 6.5

The selected area should be free from 100-year return period floods (ABNT, 1997) and should comply with soil regional uses as prescribed by law.

Table 53.17 summarises some parameters specified by EPA-625/1-083-016.

Regarding soil permeability, it should be high in the reactive layer to avoid puddles and anaerobic conditions. On the other hand, deeper than 3.0 m, low permeability (less than 1×10^{-7} cm/s) is desired to prevent infiltration. Such a water barrier can exist naturally or be made up by soil compaction or a synthetic liner.

53.7.4 Design and operational aspects

The required area must be determined in accordance with the respirometric test results and should be subdivided into several cells for easier environmental monitoring and control of the application and resting periods.

As soil conditions must be kept aerobic, if the spread sludge has a high moisture content, the application rates must be smaller.

Landfarming designs should specify sludge application rates, area handling, sludge application technology, sludge application frequency, equipment provided for process operation and soil handling regarding fertilisation and pH correction. They should also include storm water drainage system details and percolate system collection, including its corresponding treatment, if required.

A buffer area should also be sized for contingencial sludge storage, according to the particular site operational characteristics. Similar to sanitary landfills,

landfarming area projects must define appurtenances such as fences, balances, inner access roads, field office, shed and workshop for machine maintenance compatible with the site dimensions. The applied sludge should be surface spread and incorporated by an agricultural harrow.

The project must also include an environmental monitoring plan, an emergency plan and a closure plan.

53.7.5 Environmental monitoring

The unsaturated and also the saturated zones should be monitored. Both the soil and the soil solution must be monitored in the unsaturated zone to verify whether some migration from the treatment zone is occurring. The parameters subjected to monitoring should be selected in accordance with the sludge characteristics and must comply with the environmental agency requirements.

Information on the soil solution quality and the chemical soil composition below the treatment zone should be obtained from the sampling and analysis undertaken. All results shall comply with the environmental agency requirements.

The landfarming area must be built and operated preserving the groundwater quality. Groundwater monitoring should be carried out unless exempted by the environmental agency. There should be a sufficient number of installed monitoring wells, so samples withdrawn are able to truly represent the aquifer water quality. Brazilian practice (ABNT, 1997) recommends:

- The monitoring well system must consist of at least four wells: one upstream and three downstream following the direction of the preferential draining pathway of the groundwater.
- The wells must have a minimum diameter of 10 cm (4 inch) for proper sampling. To avoid contamination they must be lined and top covered.

The monitoring programme should:

- indicate the parameters to be monitored, considering the sludge characteristics and mobility of the components
- establish procedures for sampling and preservation of samples
- establish background values for all parameters of the programme. These values may come from upstream sampling before the beginning of the operation and may be later on compared to water quality results after regular start-up. Background tests have the advantage of determining when a particular contamination has occurred and whether it may be attributed or not to the start-up of a particular facility

53.7.6 Closure plan

After the area closure, the continuity of the operation in the treatment zone must be assured to achieve the highest possible decomposition, transformation and fixation of the applied constituents. The draining systems of rainwater and percolates

must also be kept operational, as well as the effluent treatment system, if existent. After closure, agricultural use of the area must not be allowed. Monitoring of the unsaturated zone must continue for one year after the last application.

Example 53.9

From Example 47.1 (Chapter 47), estimate the area needed for the sludge treatment by landfarming. The sludge comes from a treatment plant using anaerobic sludge blanket reactor (UASB) for a population of 100,000 inhabitants. Assume an application rate of 300 tonnes of sludge/ha·year (dry basis), based on Bartha's respirometric test.

Data: sludge production from Example 47.1: 1,500 kg of SS/d.

Solution:

Yearly sludge production: $1,500 \text{ kgSS/d} \times 365 \text{ d/year} = 547,500 \text{ kgSS/year}$

Application rate: 300,000 kgSS/ha year

Required area: $547,500/300,000 = 1.825 \text{ ha}$ or $18,250 \text{ m}^2$

Although the landfarming area is much smaller than the agricultural recycling area (Example 53.6), it is important to notice that a number of technical and control appurtenances are required for landfarming, such as drainage systems, banks, edgings, subsurface waterproofing, monitoring wells, etc. These are not needed for biosolid land application in agricultural areas.

Sludge transformation and disposal methods

M. Luduvic, F. Fernandes

54.1 INTRODUCTION

Worldwide urbanisation leads to the growth of large metropolitan areas, imposing constraints, amongst others, for sludge disposal alternatives. Freight costs and the adverse heavy traffic impact in metropolitan areas favours the adoption of sludge treatment and disposal alternatives within the wastewater treatment plant area. This scenario justifies the consideration of processes such as incineration and wet air oxidation.

Regardless of the adopted technology, all treatment and disposal processes present advantages and disadvantages, many of them regarding possible contamination of soil, receiving water bodies and atmosphere. Sludge combustion causes serious concerns towards atmospheric pollution and safe disposal of residual ashes.

Many countries are increasingly using the incineration process as a response to growing difficulties in maintaining landfills as a final sludge disposal route due to the increasing competition for space in landfills, disposal costs, legislation constraints and incentives to sludge recycling.

The present chapter deals with the following sludge transformation and disposal methods:

- thermal drying
- wet air oxidation
- incineration
- landfill disposal

Some of these processes are also described in other chapters of this book (Chapters 49 and 51). From the above alternatives, only landfills can be classified as a final disposal route, since the others, although presenting a high water-removal capability, still leave residues that require final disposal.

Landfills should only be selected as a final disposal alternative if wastewater sludge use is an unfeasible solution. Most municipal wastewater treatment plant sludges have physical–chemical properties useful for agriculture or industrial use, allowing the development of a more constructive attitude towards sludge. Under certain circumstances, sludge may be looked upon as a commodity and not as a useless residue.

54.2 THERMAL DRYING

Thermal drying is a highly flexible process, easily adapted to produce pellets for agricultural reuse, sanitary landfills disposal or incineration. The process applies heat to evaporate sludge moisture. The produced pellets can be used as fuel for boilers, industrial heaters, cement kilns and others. Pellet solids concentration varies from 65–95% (5%–35% water content). Main advantages of thermal sludge drying are:

- significant reduction in sludge volume
- reduction in storage and freight costs
- stabilised final product easily transported, stored and handled
- final product free of pathogenic organisms
- final product preserving the characteristics of soil amendment from sewage sludge
- final product suitable for unrestricted agronomic reuse, incineration or final disposal in landfills
- possibility of accommodation in small size packages

Main limitations of thermal drying processes are:

- production of liquid effluents
- release of gases into the atmosphere
- risk of foul odour and disturbing noise

Thermal drying processes may be classified as *indirect*, *direct* or *mixed*. Indirect processes produce pellets with up to 85% solids concentration. For solids contents higher than 90% and possible production of organomineral fertilisers, direct drying processes are recommended.

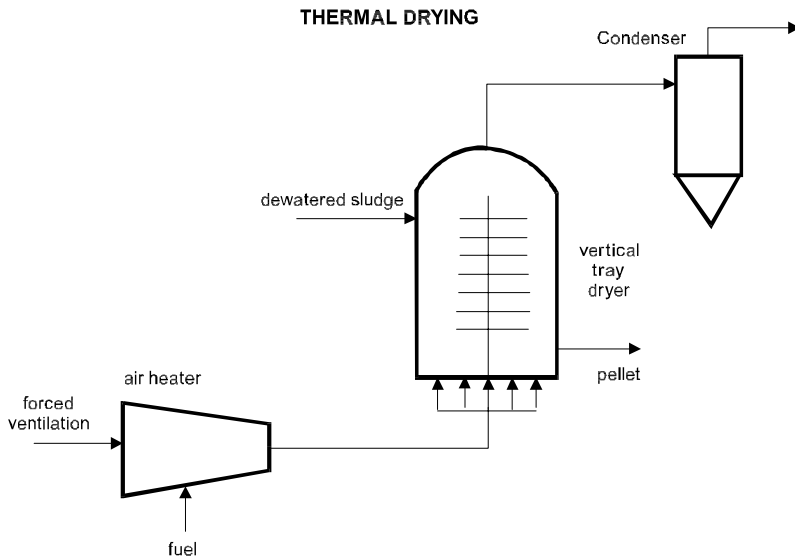

Figure 54.1. Thermal drying process operation

Liquid effluent is less than 1% of the total treatment plant flow and may be recycled to the plant headworks, provided sufficient capacity is available to deal with the additional organic load. When thermal drying anaerobic-sludge, surplus ammonia nitrogen may become a problem during liquid effluent treatment.

Both direct and indirect drying processes produce gaseous emissions with foul odours potential. The odour associated with the dry product, although less intense, is similar to the original sludge odour. It is highly recommended that the drying unit be isolated, preferably under a negative pressure environment to minimise gaseous release hazards.

Figure 54.1 presents a thermal drying process operation.

54.3 WET AIR OXIDATION

Originally developed in Norway for paper industry residues treatment, wet air oxidation was adapted for sewage sludge treatment in the United States during the 1960s. Despite its promising start, it did not achieve the expected results and was later adapted to treat high-toxicity industrial liquid wastewater. Wet oxidation is recommended when the effluent is too diluted to be incinerated, and toxic/refractory to be submitted to biological treatment.

The process is based on the capability of dissolved or particulate organic matter present in a liquid to be oxidised at temperatures in the range of 100 °C–374 °C (water critical point). The temperature of 374 °C limits the water existence in liquid form, even at high pressures. Oxidation is accelerated by the high solubility of oxygen in aqueous solutions at high temperatures. The process is highly efficient

in organic matter destruction of effluents in the 1%–20% solids concentration range, allowing enough organic matter to increase the reactor internal temperature through heat generation without external energy supply. The upper 200 g/L (20%) solids concentration limit avoids the surplus heat to raise the temperature above the critical value, which could lead to complete evaporation of the liquid. Wet air oxidation of organic matter can be described by Equation 54.1.

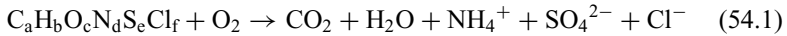

Theoretically, all carbon and hydrogen present can be oxidised to carbon dioxide and water, although factors such as reactor internal temperature, detention time and effluent characteristics influence the oxidation degree achieved. As can be noticed from Equation 54.1, organic nitrogen is converted into ammonia, sulphur into sulphate, and halogenated elements into their Cl^- , Br^- , I^- and Fl^- ions. These ions remain dissolved, and there is no production of sulphur or nitrogen oxides (SO_x and NO_x).

Due to the exothermic characteristic of Equation 54.1, the wet air oxidation process is able to produce sufficient energy to maintain a self-sustaining process. The autogenous operation calls for influent COD concentrations higher than 10 g/L, only a fraction of the 400 g COD /L concentration required to maintain autogenous operation in incinerators.

Recent technological developments and restrictions imposed by environmental legislation to final sludge disposal in several countries have renewed the interest in wet air oxidation use for sewage sludge stabilisation. Wet air oxidation processes are currently, once again, being considered for wastewater treatment plants serving large metropolitan areas.

Sewage sludge organic matter, when submitted to wet air oxidation, may be considered *easily oxidisable* or *not easily oxidisable*. In the first category are proteins, lipids, sugars and fibres, the most usual constituents of sludge, which account for approximately 60% of the total organic matter.

The main control variables of the wet air oxidation process are (a) temperature, (b) pressure, (c) air/oxygen supply and (d) solids concentration.

The process may be classified according to the working pressure as:

- *low pressure oxidation*
- *intermediate pressure oxidation*
- *high pressure oxidation*

The main purpose of low-pressure wet air oxidation is to reduce sludge volume and increase its dewaterability for thermal treatment, whereas intermediate and high-pressure oxidation are conceived to reduce sludge volume through oxidation of volatile organic matter into CO_2 and water.

In spite of its efficiency, wet air oxidation process is far from being a complete process and its application at an industrial scale requires efficient operation and maintenance. The most usual problems in industrial scale are:

- foul odours
- corrosion of heat exchangers and reactors

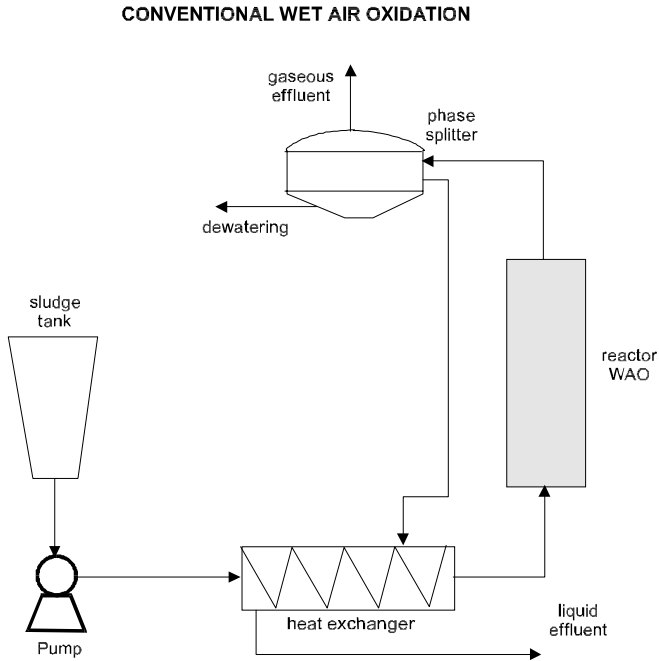

Figure 54.2. Conventional wet air oxidation system with a vertical reactor

- required power consumption to start-up the oxidation process
- high COD in liquid effluent
- high metal content in residual ashes

Figure 54.2 shows a vertical reactor wet air oxidation system. The influent sludge is pumped towards the Wet Air Oxidation (WAO) reactor, passing through a heat exchanger to raise its temperature. The WAO reactor effluent goes through a phase splitter, routing the sludge for dewatering, whereas the liquid flows back through the heat exchanger, where part of the heat is transmitted to the incoming sludge. The gaseous effluent is released into the atmosphere after being treated by an electrostatic precipitator and filtered for solid particles and odorous substances removal.

Wet air oxidation may use air or pure oxygen as oxygen supply. Compressed air as an oxidising agent is usually found in wastewater treatment plants.

Comparative studies for effluent treatment with up to 20% of solids have shown that capital costs for a wet air oxidation process are higher than those required for an incinerator, although the operational cost of the former is significantly lower, due to less external energy required. Wet air oxidation can treat almost any type of organic sludge produced at domestic or industrial wastewater treatment plants. The solid produced is sterile, not putrescible, settles readily and may be easily mechanically dewatered. Solids low nitrogen concentration and fairly high metals

Table 54.1. Typical operational ranges of wet air oxidation treatment of sewage sludges

Parameter	Type of oxidation process		
	Low pressure (thermal treatment)	Intermediate pressure	High pressure
Pressure (atm)	20.5–27.3	27.3–54.6	54.6–136
Temperature (°C)	148–204	204–260	260–315
Organic matter destruction (%)	5–10	10–50	50–90
Volume reduction (%)	25–35	30–60	60–80
Sludge sterilisation	yes	yes	yes
Autothermal reaction	no	yes	yes
Improvement in dewaterability	yes	yes	yes

content may render it unsuitable for land application aiming agricultural reuse, adding constraints for its final destination.

The gaseous output from a wet air oxidation process is a mixture of nitrogen, oxygen, carbon dioxide and hydrocarbons. The release of foul odours is directly dependent on the oxidation degree achieved inside the reactor.

A significant COD removal occurs and a large portion of it is transformed into low-molecular-weight volatile acids (e.g., acetic acid, propionic acid and others), which may reach COD values around 5,000–10,000 mg/L.

The liquid phase from intermediate and high-pressure wet air oxidation has smaller organic content and may be biologically treated. Its organic content is composed of low-molecular-weight volatile acids and amino acids. The COD:BOD ratio is about 2 and removal efficiencies higher than 80%–95% for COD and BOD are achievable. The process supernatant may be biologically treated, either by anaerobic reactors or activated sludge.

Table 54.1 presents a comparison among the main wet air oxidation processes used for sewage sludge treatment.

Wet air oxidation units are considered highly sophisticated, requiring skilled personnel for operation and maintenance. All reactor material should be made of stainless steel 316 to avoid corrosion from formed acids.

Wet air oxidation technology has been combined with the activated sludge process (Deep Shaft Technology), with reactors going down as deep as 1.6 km to achieve sludge treatment. Wet air oxidation in deep shafts makes pumps, heat exchangers and high-pressure reactors unnecessary items, which significantly diminishes capital costs. Deep Shaft Technology has been recommended where space is at a premium.

54.4 INCINERATION

Incineration is the sludge stabilisation process which provides the greatest volume reduction. The residual ashes volume is usually less than 4% of the dewatered sludge volume fed to incineration. Incinerators may receive sludge from several treatment plants and are usually built to attend over 500,000 population equivalents, with capacities higher than 1 tonne/hour.

Table 54.2. Calorific power of different types of sewage sludge

Type of sludge	Calorific power (kJ/kg dry solids)
Raw primary sludge	23,300–29,000
Anaerobically digested sludge	12,793
Activated sludge	19,770–23,300

Source: Adapted from WEF (1996)

Sludge incineration destroys organic substances and pathogenic organisms through combustion obtained in the presence of excess oxygen. Incinerators must use sophisticated filter systems to significantly reduce pollutant emissions. Gases released to the atmosphere should be regularly monitored to ensure operational efficiency and safety.

Incinerator design requires detailed mass and energy balances. In spite of the considerable concentration of organic matter found in dewatered sludge, sludge combustion is only autogenous when solids concentration is higher than 35%. Dewatered cakes with 20 to 30% total solids can be burned with auxiliary fuels, such as boiler fuel having low sulphur content. The calorific value of sludge is fundamental in reducing fuel consumption. The combustible components found in sludge are carbon, sulphur and hydrogen, present as fat, carbohydrates and proteins. Table 54.2 shows typical calorific values of different types of sludge.

Products from complete combustion of sludge are water vapour, carbon dioxide, sulphur dioxide and inert ashes. Good combustion requires an adequate fuel/oxygen mixture. Oxygen requirement for complete combustion is usually much higher than the stoichiometric value of 4.6 kg of air for every kg of O₂. Generally, 35%–100% more air is required to assure complete combustion, the necessary excess air depending upon the sludge characteristics and the type of incinerator.

The amount of oxygen needed for complete combustion of the organic matter can be determined from the identification of the organic compounds and from the assumption that all carbon and hydrogen are oxidised into carbon dioxide and water. The theoretical formula can be expressed as:

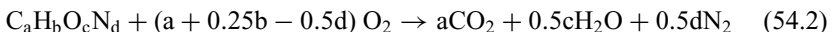

Two types of incinerators are currently in use for sewage sludge:

- *multiple chamber incinerator*
- *fluidised bed incinerator*

A multiple chamber incinerator is divided into three distinct combustion zones. The higher zone, where final moisture removal occurs, the intermediate zone where combustion takes place and the lower or cooling zone. Should supplementary fuel be required, gas or fuel oil burners are installed in the intermediate chamber.

A fluidised bed incinerator consists of a single-chamber cylindrical vessel with refractory walls. The organic particles of the dewatered sludge remain in contact with the fluidised sand bed until complete combustion.

Table 54.3. Example of the influence of solids concentration in a fluidised bed incinerator operation

Parameter	Sludge with 20% solids	Sludge with 26% solids
Volatile organics (%)	75	75
Available energy (MJ/mt DS)	3,489	4,536
Exhaustion temperature (°C)	815	815
Excess air required (%)	40	40
Air temperature (°C)	537	537
Fuel consumption (L/mt DS)	184	8
Processing capacity (kg DS/hour)	998	1,361
Power (kWh/ mt DS)	284	207
Gas washing water (L/mt DS·s)	30	26
Operating time (hour/d)	18.2	13.3

Source: Adapted from WEF (1992). DS = dry solids; mt = metric ton = 1,000 kg.

The present trend favours fluidised bed incinerator over multiple chamber furnaces, due to smaller operational costs and better air quality released through its chimney. Operation under autogenous conditions at temperatures above 815 °C assures complete destruction of volatile organic compounds at cost-effective price. Dewatering equipment nowadays is able to feed cakes higher than 35% total solids to incinerators, making autogenous combustion operation feasible. Table 54.3 illustrates the advantage of feeding sludge with higher solids concentration to a fluidised bed incinerator.

Use of incinerators in sludge treatment is restricted to wastewater treatment plants serving large urban areas due to high costs and sophisticated operation involved. Nevertheless, restrictions to agriculture sludge reuse caused by excessive metals concentrations, long hauling distance and volume constraints in urban landfills may favour incineration as a viable alternative for wastewater sludge treatment.

Atmospheric emissions from incinerators are controlled by optimising the combustion process and using air filters. Air pollutants released consist of solids evaporated or compounds formed during combustion, the main ones being:

- nitrogen oxides (NO_x)
- incomplete combustion products – carbon monoxide (CO), dioxins, furans, etc.
- acidic gases: sulphur dioxide, hydrochloric acid and hydrofluoric acid
- volatile organic compounds: toluene, chlorinated solvents

Solids are also present in atmospheric emissions from incinerators, consisting of thin particulate matter made up of metals and suspended solids condensable at room temperature. The metals concentration in suspended solids is directly dependent on the incinerated sludge quality. Electrostatic precipitators are widely used for removal of particulate matter from incinerator emissions.

In spite of considerable reduction in sludge volume, incineration cannot be considered a final disposal route, as residual ashes require an adequate final disposal.

Table 54.4. Typical composition of ashes from wastewater sludge incineration

Component	Composition (in dry weight)
SiO ₂	55%
Al ₂ O ₃	18.4%
P ₂ O ₅	6.9%
Fe ₂ O ₃	5.8%
CaO	5.4%
Cu	650 mg/kg
Zn	450 mg/kg
Ni	100 mg/kg
Cd	11 mg/kg

Efficient combustion assures complete destruction of organic matter present in the ashes inert inorganic matter with a considerable concentration of metals. The quantity of residual ashes varies according to the sludge being incinerated. For raw sludge 200–400 kg/tonne may be expected, whereas for digested sludge, 350–500 kg/tonne might be produced, due to the smaller concentration of volatile solids. Table 54.4 shows typical composition of ashes from wastewater sludge incineration.

Risks of inadequate ashes disposal are associated with the possible leaching of metals and their later absorption by plants. Final disposal in landfills is the most suitable ash disposal alternative, bearing in mind that disposal onto soil is not advisable. More recent technologies use a cement and ashes mixture, assuring reliable metals retention.

It is also possible to co-incinerate sludge in cement kilns or in thermoelectric power plants using mineral coal as fuel. Co-incineration reduces incineration capital as well as operational and maintenance costs, since they are integrated to the industrial process train.

Figure 54.3 shows a fluidised bed incinerator with washing system and gas cooling.

54.5 LANDFILL DISPOSAL

54.5.1 General considerations

Landfill is a technique for safe disposal of solid urban refuse onto soil, with no damage to public health and minimum environmental impacts, using engineering methods able to confine the disposed waste within the least possible area and smallest possible volume, covered with a soil layer after each working day, or at smaller time intervals, if necessary (ABNT, 1992).

For sludge disposal in landfills there is no concern regarding nutrients recovery or sludge use for any practical purpose. Anaerobic biodegradation takes place in sludge confined within cells, generating several by-products, including methane.

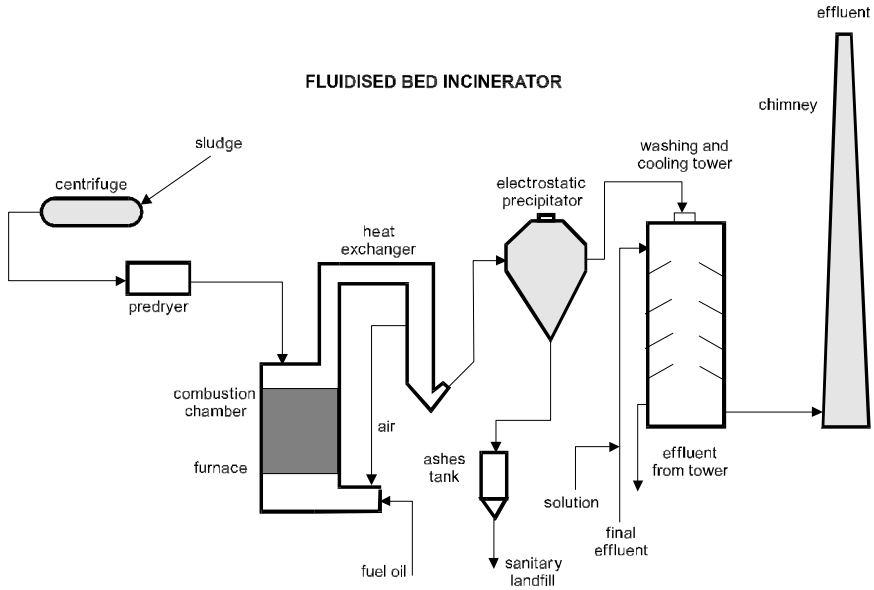

Figure 54.3. A fluidised bed incinerator with washing and cooling gas systems (adapted from CIWEM, 1999)

Sludge disposal into landfill depends on sludge properties and landfill characteristics. Two types of landfill disposal may be considered:

- **Exclusive (dedicated) sanitary landfills:** especially designed and constructed to receive sewage sludge, incorporating special features to cope with specific sludge properties and to comply with environmental constraints. Usually requires thermally dried sludges or cakes with high solids contents (>30%).
- **Co-disposal with urban solid waste:** wastewater sludge is disposed of in a landfill with municipal solid wastes. Mixing of sludge with urban wastes tends to accelerate the biodegradation process as a function of the nitrogen content and the sludge inoculation potential. The inconvenience of this alternative is the reduction of landfill lifetime if the amount of sludge is significant.

There are a significant number of technologies available to build, operate and maintain both types of landfills, as alternatives to land disposal of sludge.

Sludge from domestic wastewater treatment may be considered a non-inert residue, and is generally classified as non-hazardous residue. As a matter of fact, a number of sewage sludge samples have undergone waste extraction tests or metal leaching tests and solubilisation tests (Santos, 1996), demonstrating that sludge from municipal treatment plants is not a hazardous waste. Conversely, if wastewater contains a high concentration of industrial effluents, sludge may become heavily

contaminated, requiring disposal at a landfill site licensed to handle hazardous waste.

Landfills are a flexible solution as they may accommodate variable sludge volumes, absorb excess demands from other forms of final destination and operate independently from external factors. Sludge characteristics such as degree of stabilisation or pathogen level are not of primary concern while choosing landfill as a final disposal route.

An important consideration for a monofill implementation is availability of suitable land not far from the wastewater treatment plant. Site selection should be based on an extensive study applying multi-disciplinary criteria to locate the best environmental and economical option.

Besides approval from the environment agency and full compliance with stringent standards, neighbouring population of a future landfill site should be listened to and have their concerns taken into consideration during the design and construction phases.

54.5.2 Area selection and environmental impact considerations

One of the first activities that must be accomplished in a sanitary landfill project is an extensive evaluation of the environmental impacts associated with different implementation and operational phases of the landfill. Environmental assessment allows project definition of protection measures necessary to control and minimise negative impacts. Landfill site selection is critical, and several impacts may be eliminated or minimised if the selected site presents favourable characteristics. Landfill, when not properly designed or operated, may cause pollution to:

- air, through foul odours, toxic gases or particulate material
- surface water bodies, through percolate drainage or sludge transport by run-off
- soil and groundwater, by infiltration of percolated liquids

Table 54.5 presents a list of main environmental impacts one should take into consideration while searching for a suitable area to locate a landfill site.

A landfill site selection process should take into consideration the following steps:

- selection of macro-regions, considering access and waste generating points
- identification of all legal constraints within macro-regions and exclusion of affected areas
- preliminary evaluation of the remaining macro-regions, analysing:
 - topographic requirements: dry valleys and hillsides with slopes below 20%
 - geological and hydrogeological requirements: low-permeability lithology, not excessively fractured, soils not excessively deformable, ideally located near the watershed limit, and water table depth greater than 1.50 m

Table 54.5. Main environmental aspects for selection of landfills sites

Aspect to be considered	Characteristics to be evaluated
Surface and groundwater	Site geology and hydrology Localisation of surface water bodies Site location within the watershed and local use of water resources Local climate
Air	Local climate Direction of prevailing winds Distance and transition areas to housing developments
Soil	Soils characteristics Local flora and fauna Site geology and hydrology
Anthropic environment	Landscape changes Aesthetic changes Distance from housing developments Direction of prevailing winds Change in land value Local legislation

Source: Gómez (1998)

- preliminary selection using aerial photos to determine favourable sites located in the remaining areas that comply with the selective criteria listed above
- field survey and preliminary selection taking into account all gathered information
- development of technical studies comparing all potential areas
- environmental licensing of the selected landfill site

Although site selection is always complex, the level of complexity and design detail to be considered during this phase is a function of the volume of sludge to be disposed of.

54.5.3 Exclusive landfills or monofills

Exclusive landfills, dedicated landfills or monofills are designed to exclusively receive wastewater sludge. Most exclusive landfills in the United States use trenches, with 1–15 m width (Malina, 1993). Narrow trenches (1–3 m wide) allow truck unloading without vehicle traffic onto the disposal ditch. When narrow trenches are used, sludge total solids content can be lower than 30%, since it will be supported by the trench side walls. This kind of landfill requires large areas but allows operational simplicity and is recommended for small sludge volumes.

Large trenches (3–15 m wide) allow trucks' access to the disposal ditches to unload sludge. They require solids concentrations higher than 40% to support vehicle traffic (Nogueira and Santos, 1995).

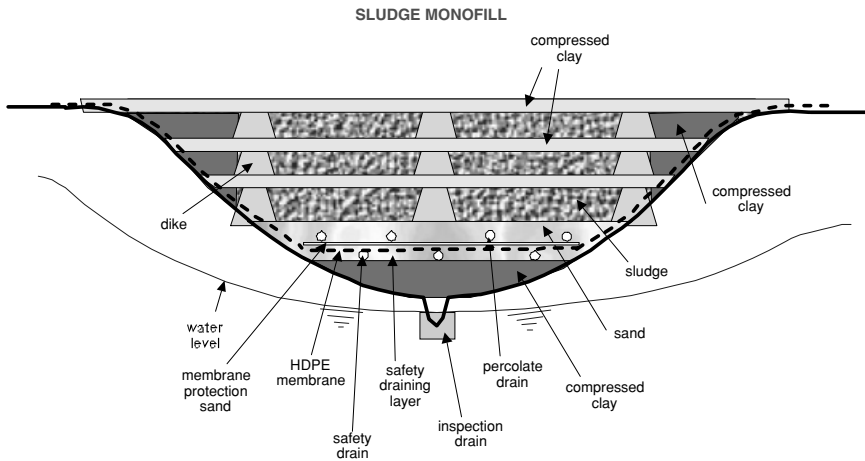

Figure 54.4. Cross section of a large sewage sludge monofill, comprising over-layered cells and dikes

Narrow trenches may accommodate 450–2,100 tonnes of sludge cakes (dry basis) per ha, including areas between trenches. Wide trenches, on the other hand, may be landfilled with 1,200–5,500 tonnes/ha (Malina, 1993).

Both concepts based on trenches are simple, proven technologies. Large size landfills require alternative engineering solution to allow the disposal of large volumes of sludge cakes in a relatively small area. Figure 54.4 presents an example of a landfill, with large over-layered cells spaced by dikes.

54.5.4 Co-disposal with municipal solid wastes

Co-disposal with municipal solid wastes requires sludge cakes with a solids concentration of at least 20%, otherwise leachates may increase excessively in the landfill, threatening side slopes stability.

In many places, bulldozers are usually employed for wastes compression and cell implementation. Low solids content sludge cakes may stick to tractor track plates, reducing its compaction capability.

Co-disposal has a lower application rate when compared to monofill rates, ranging from 200–1,600 tonnes/ha, on a dry basis (Malina, 1993). These are merely referential figures, as the sludge/urban waste ratio must be defined as a function of the characteristics of both residues and landfill itself.

54.5.5 Basic design elements

(a) Landfill capacity

Landfill sizing should be calculated based upon the sludge volume to be disposed of during a certain period, which usually ranges between 15 and 20 years. Future

Table 54.6. Example of required landfill volumes (demand factor) depending upon sludge total solids

Solids content in the sludge (%)	Volumetric demand per tonne of dry matter (m ³ /tonne dry solids)
15	6.93
20	5.43
25	4.30
40	2.75
90	1.10
Ashes	0.32

Source: Fernandes (1999)

expansions of the leachate drainage system should be anticipated in the design, considering yearly increments in wastewater sludge plus municipal refuse volumes. Sludge volumes should be computed according to the daily production on a dry basis. Moisture content will severely impact transportation, occupied volume and landfill operation, as exemplified in Table 54.6.

High moisture sludge cakes, besides occupying large fill volumes, may also lead to subsidence of the buried volumes due to the significant water losses resultant from landfill leaching.

The required monthly volume can be calculated as follows:

$$V = P.C.F \times 30 \quad (54.3)$$

where:

V = required fill volume for one month sludge cakes (m³/month)

P = daily sludge production, on a dry basis (tonne/day)

C = soil daily covering factor (usually 1.2 to 1.5)

F = volume demand factor (m³ of landfill per tonne of sludge cakes on a dry basis)

(b) Impermeabilisation of landfill bed

The earthmoving cutting plan of soil should be impermeable to prevent leaks and groundwater contamination.

Well-compressed clayey soil can reach an acceptable permeability coefficient ($K < 10^{-7}$ cm/s) if layer thickness is suitable.

Flexible membrane liners (FML) of various thicknesses are commercially available for non-hazardous wastes, such as wastewater sludges and/or municipal solid wastes. An FML thickness of 1–2 mm is usually considered acceptable.

(c) Stormwater drainage system

Surface drains are intended to detour stormwater and reduce the amount of leaching liquids in the landfill. Its network must be designed according to site

topography, avoiding the landfill leachate collection system and soil erosion at discharge point.

Definitive drainage collectors are usually made of open concrete pipes, whereas temporary drain systems, due to the dynamic landfill construction feature, may consist of open corrugated metal pipe, or a riprap channel.

Storm water drainage system must be compatible with the size of the catchment area, top soil permeability, rainfall rate and other site characteristics.

(d) Leachate collection system

Drainage sizing is not a simple task, as leachate flow depends upon a number of intervening factors, mainly local rainfall rate and moisture content of landfilled sludge.

Leachate collection system consists of a small-slope underground ditch, usually excavated in the soil. A porous non-woven geotextile membrane is put along the ditch bottom and large diameter rocks are settled on top. Once the rocks are conveniently placed, the blanket is folded wrapping up the rocks. A layer of coarse sand is then spread over the membrane for further protection against geotextile clogging before sludge is finally applied on top.

(e) Gas collection system

Anaerobic decomposition of the organic matter produces gases (CH_4 , CO_2 , H_2S and others), which need to be collected to avoid its uncontrolled dispersion.

Gas collection system may consist of perforated pipes, vertically settled, externally surrounded by stones to keep holes free from clogging, and horizontally apart no more than 50 m from each other. They are usually settled over the leaching collection system, facilitating gas circulation.

(f) Leachate treatment

As leachates contain a high concentration of pollutants (Table 54.7), they should not be disposed of before undergoing treatment.

Table 54.7. Typical ranges for leachates constituents

Parameter	Concentration
TOC	100–15,000 mg/L
COD	100–24,000 mg/L
Cd	0.001–0.2 mg/L
Cr	0.01–50 mg/L
Zn	0.01–36 mg/L
Hg	0.0002–0.0011 mg/L
Pb	0.1–10 mg/L
Faecal coliforms	2,400–24,000 MPN/100mL

Source: Malina (1993)

Table 54.8. Support buildings and appurtenances in sludge landfills

Item	Comments
Sentry-box	Intended for controlling admittance. May have logbooks, notepads and documentation regarding truck weighing, if necessary
Scale	Necessary if hauling payment is based on weight carried to site
Isolation distances	The area must be enclosed to avoid foreign personnel admittance. A wire fence or a barbed wire may be provided. A live shrub fence is advised as visual barrier
Shed and workshop	A shed with dimensions compatible with machine and materials routinely used should be provided. This shed can also keep basic tools used in machinery daily maintenance
Office	Located nearby the sentry-box or in another place within the site. The office should keep landfill operational record data, documentation, change rooms and water closets
Internal roads	Access inner roads allow truck traffic to the working front and may change from time to time due to landfill dynamics. Roads shall assure good transit even in rainy days

Biological methods are usually employed for leachate treatment. Conventional stabilisation ponds are not recommended when leachates are highly concentrated. There is no widely accepted solution for leachate treatment systems. One of the difficulties is simply the heterogeneity of the effluent, with a broad variation in composition due to the large range of wastes disposed of in landfill sites. The most used leachate treatment process is the aerobic biological treatment, however, special attention is required while assessing nutrients availability, as nutrient addition may be necessary. Physicochemical treatment is also employed, mainly to improve effluent quality (polishing) and to reduce metals and phosphorus concentration. Other solutions, such as recycling or irrigation, might also be feasible if leachate volumes are not excessively high.

54.5.6 Support buildings

Table 54.8 shows main ancillary buildings and appurtenances usually needed in a landfill site.

54.5.7 Landfill monitoring

The landfill must be monitored throughout its lifetime and for many years after operation is discontinued, since leachates and gases will continue to be produced for over 20 years after its closure.

Water table monitoring is certainly the most important item to be evaluated. This may be done using 30-cm diameter monitoring wells made with PVC or steel lining. Perforation must cease few meters below the water table level and the shaft must have its top end sealed to keep water off outer contamination.

All water inside the pit should be drained off using a portable pump before sample collection takes place. Collecting frequency and parameters to be analysed must be defined in the monitoring plan.

For municipal solid waste landfills, one monitoring well is recommended upstream and three downstream, located at convenient places. Wells location should be performed by an experienced hidrogeologist according to a monitoring plan approved by the local environmental agency.

The monitoring should also include other items, such as gas production and differential settlement control, according to the assigned future use of the area.

54.5.8 Landfill closure

Once the useful volume of a landfill is filled, its lifetime is over and the area can be released for other uses.

The landfill project must consider a closure plan defining the future use of the area. This is very important, as it can orient the operation of the landfill, especially when close to lifetime span, when levels and plans need to be implemented to conform to the expected future use.

Since landfill sites are usually far from the urban perimeter, the future use of the area is normally associated with parks, green areas and sports activities. Housing projects should not be allowed, unless adequate foundation, gas collection system and safety measures are provided.

Example 54.1

From Example 47.1 (Chapter 47), wastewater from 100,000 inhabitants is treated by an anaerobic sludge blanket reactor (UASB). Estimate the area yearly needed for disposal of the dewatered sludge in an exclusive sanitary landfill using both alternatives: narrow (3 m) and large (15 m) trenches. Data from Example 47.1:

- Dewatered sludge solids production: 1,500 kgSS/d
- Daily dewatered sludge volume production: 4.0 m³/d
- Sludge density: 1,050 kg/m³

Trench dimensions adopted in this example:

- Trench length: 100.00 m
- Trench depth: 2.50 m

Solution:

(a) *Initial information*

$$\begin{aligned} \text{SS concentration in sludge to be landfilled} &= (1,500 \text{ kg/d}) / (4,0 \text{ m}^3/\text{d}) \\ &= 375 \text{ kg/m}^3 \end{aligned}$$

$$\text{Solids content} = (375 \text{ kg/m}^3) / (1,050 \text{ kg/m}^3) = 0.36 = 36\%$$

Example 54.1 (Continued)

Trench depth is defined by the water table level and available equipment. Small size bulldozers can deal with 2.50 m depth trenches. This is a popular equipment amongst local government departments as well as contractors. The 2.50 m depth assumes a minimum vertical distance of 1.50 m between the trench bottom and the water table level.

(b) Narrow trenches (3 m)

Volumetric capacity of each trench: $3.00 \text{ m} \times 2.50 \text{ m} \times 100.00 \text{ m} = 750 \text{ m}^3$

A daily disposal routine requires sludge to be covered at the end of every day shift. Assuming a 25% soil-to-sludge ratio by volume, the trench will be able to store $750 \text{ m}^3 / (1.00 + 0.25) = 600 \text{ m}^3$ of sludge (wet weight). The remaining 150 m^3 is for soil cover volume.

Example 47.1 shows that for a dewatered sludge volume of $4.0 \text{ m}^3/\text{d}$ and specific weight of 1.05, the total sludge mass (dry solids + water) hauled to the landfill is $4.0 \times 1.05 = 4.2 \text{ tonne}/\text{d}$. The weight determination is necessary whenever freight is paid by weight instead of volume.

Therefore, 1 m^3 of landfill volume can accept 1.05 tonne of sludge (wet weight). Then:

Yearly sludge production: $4.2 \text{ tonne}/\text{d} \times 365 \text{ d}/\text{year} = 1,533 \text{ tonne}/\text{year}$.

Yearly sludge volume: $4.0 \text{ m}^3/\text{d} \times 365 \text{ d}/\text{year} = 1,460 \text{ m}^3/\text{year}$.

Number of required cells: $(1,460 \text{ m}^3) / (600 \text{ m}^3/\text{cell}) = 2.43 \text{ cells}$.

Assuming 10 m between contiguous cells and not computing external border space, which is variable from site to site, and assuming a rectangular shaped terrain, a possible cell arrangement is presented in the following diagram:

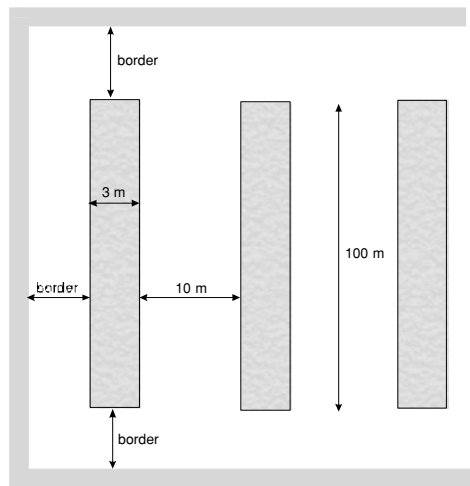

Example 54.1 (Continued)

In a period of one year 2.43 cells are necessary.

The effective area occupied by the cells is:

$$\text{Area} = 2.43 \times 100 \text{ m} \times (3 \text{ m} + 10 \text{ m}) = 3,159 \text{ m}^2/\text{year}$$

This area may change if depth and distribution of the cells are rearranged.

(c) Large trenches (15 m)

Volumetric capacity of each trench: $15 \text{ m} \times 2.5 \text{ m} \times 100 \text{ m} = 3,750 \text{ m}^3$.

Assuming 25% as the covering coefficient, the useful capacity will be $3,750 \text{ m}^3/1.25 = 3,000 \text{ m}^3$.

Yearly sludge volume: $1,460 \text{ m}^3/\text{year}$ (calculated in Item b)

Number of cells required: $(1,460 \text{ m}^3)/(3,000 \text{ m}^3/\text{cell}) = 0.49$ cells

Just 0.49 cell would be sufficient to absorb the yearly sludge production, which is equivalent to saying that one cell shall be enough to absorb the sludge production of approximately 2 years.

Assuming the same spacing between cells, the yearly needed area is:

$$\text{Area} = 0.49 \times 100 \text{ m} \times (15 \text{ m} + 10 \text{ m}) = 1,225 \text{ m}^2/\text{year}$$

(d) Comments

In this particular case, considering a 36% total solids sludge cakes, any of the two alternatives could be used. If centrifuges or belt presses had been used for sludge dewatering, solids content would be below 25%, and large trenches would not be recommended, due to their incapability to support traffic vehicles onto sludge layers.

It is interesting to notice from Table 54.6 how significant is the impact of sludge cake solids content in landfill: as solids content increases, the required volume for disposal is substantially reduced. As it can be seen, a 15% total solids sludge demands 6.93 m^3 of useful landfill volume for 1.0 tonne of sludge (dry basis), whereas a 25% solids sludge demands a landfill volume of only 4.30 m^3 per tonne (dry basis).

Environmental impact assessment and monitoring of final sludge disposal

A.I. de Lara, C.V. Andreoli, E.S. Pegorini

55.1 INTRODUCTION

Feasible alternatives for final sewage sludge disposal, as stated by Agenda 21, are a worldwide concern. They should focus on adequate waste management and accomplish the following principles: all residues should be minimised, reuse and recycling should be practised whenever possible and remaining residue should be properly disposed.

The primary concern of the selected sludge disposal alternative should be health and environmental protection. Achievement of such goals requires a sound assessment of environmental impacts and risks regarding the selected disposal method, aiming to minimise negative impacts and emphasise the positive ones.

From the early stages of a wastewater treatment plant planning and design, beneficial use or final disposal alternatives for the produced sludge should be considered, along with pertinent technical, economic, operational and environmental aspects of the problem. The entity that generates a residue is responsible for its safe and adequate destination, and this is particularly true for water and sanitation companies.

The hazards and indicators of risk associated with sludge disposal methods are discussed in the present chapter, together with the corresponding monitoring programme. It should be emphasised that impacts can be positive or negative, that is, they can add value or depreciate a particular disposal alternative. A summary of the main sludge disposal alternatives is listed in Table 5.16 (Chapter 5), with a balance between advantages and disadvantages presented in Table 5.17. Chapters 53 and 54 discuss positive and negative impacts, but these are analysed in the present chapter in an integrated view with the main disposal alternatives.

55.2 POTENTIALLY NEGATIVE ENVIRONMENTAL IMPACTS

Table 5.18 (Chapter 5) presents potential environmental hazards or impacts related to the main sludge disposal alternatives. These impacts may be more or less complex, depending upon the amount of sludge to be disposed of and on the physical, chemical and biological characteristics of the sludge, as well as frequency, duration and extent of the disposal. These factors, amongst others, determine the importance and magnitude of the impacts related with the selected sludge disposal alternative.

The present section analyses negative impacts arising from the following sludge disposal routes:

- ocean disposal
- incineration
- sanitary landfill
- landfarming
- beneficial land application

(a) Ocean disposal

Marine disposal is a forbidden practice in most countries, since it is potentially able to produce negative impacts to the marine environment. Sewage sludge may bring pathogens, toxic organic compounds and metals. Some of these may settle to the bottom of the sea, contributing to alter the benthic community, leading to death of sensitive species, or bioaccumulating metals and toxic compounds in the trophic chain, finally reaching human beings through ingestion of contaminated fish and mussels. Moreover, plankton growth and resulting increase in dissolved oxygen consumption is furthered by nutrients in sludge.

According to Loehr (1981), estimates about sludge disposal impacts on oceans are not consolidated. There is not enough information about the residue dispersion dynamics in seawater, organic matter decomposition rate, transport of toxic elements and pathogenic organisms, composition of benthic fauna and production of aquatic wildlife in coastal areas. These arguments show that marine disposal is an alternative whose environmental effects cannot be easily measured and controlled.

Table 55.1. Potential air pollution due to sludge incineration

Pollutant source in sludge	Pollutant
Volatile solids	Organics (PCB and others) Odour Hydrocarbons
Ashes	Suspension of particulates Metals
Burning process	Carbon monoxide Partially oxidised hydrocarbons Sulphur oxides (SO ₂ , SO ₃) Nitrogen oxides (NO _x)
Ashes handling	Pollutants in ashes
Auxiliary fuel incineration	Ash pollutants Pollutants from combustion process

(b) Incineration

Incineration is not considered as a final disposal practice by several authors, since this process generates ashes as residue, which must be adequately disposed of. Depending on the sludge characteristics, 10 to 30% of the total dry solids are transformed into ashes, which are commonly landfilled. Ashes landfilling are an additional impact related to incineration, since compounds not eliminated by thermal destruction, as metals, are concentrated in the ashes.

The main impact of sludge incineration is air pollution through emission of gases, particulates and odour (see Table 55.1). The severity of this impact may be higher if the system is not properly operated. Neighbouring communities may face health problems due to atmospheric pollution and are directly affected by the aesthetic aspects.

(c) Landfill

Like any other form of wastewater sludge disposal, sludge monofills or co-disposed with municipal solid wastes require adequate site selection.

The main impact of landfills is on surface or groundwater that might become contaminated by leaching liquids carrying nitrates, metals, organic compounds and pathogenic microorganisms. As a result of the anaerobic stabilisation process carried out in landfills, gases are produced, which need to be exhausted and controlled.

Environmental impacts from landfilling wastewater sludges may decrease if the site is well located and protected, leachate treatment is provided, gases are properly handled and the landfill is efficiently managed and operated.

(d) Landfarming

Landfarming is an aerobic treatment of the biodegradable organic matter that takes place on the upper soil layer. Sludge, site, soil, climate and biological activity

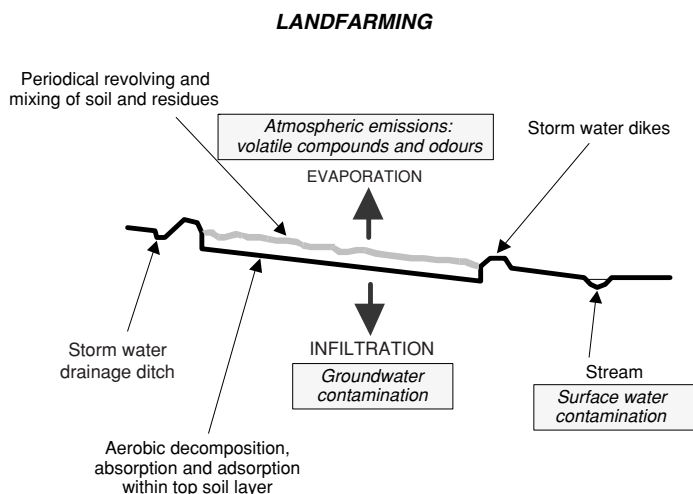

Figure 55.1. Schematics of landfarming and possible associated environmental impacts (adapted from CETESB, 1985)

interact in a complex dynamic system in which the component properties modify with time. Since it is an open system, wrong planning and management may cause contamination of water sources, food and soil itself (Figure 55.1).

Land treatment of wastewater sludges are usually destined for environmentally hazardous residues with high concentration of hardly decomposable pollutants which, when successively applied, will accumulate on soils. These substances may then render the landfarming areas impracticable for any further use.

(e) Beneficial land application

Land application of sludge may alter the physical, chemical and biological soil characteristics. Some changes are beneficial, whilst others may be undesirable. Positive impacts are related to organic matter and nutrients added to soil, fostering its physical and chemical properties and microbial activity.

Negative impacts are consequences of (a) accumulation of toxic elements, mainly metals, organics and pathogens, on soil; (b) leaching of constituents resulting from sludge decomposition, mainly nitrates; (c) storm run-off flows, contaminating nearby areas and water bodies; (d) volatilisation of compounds that, although less significant, may lead to foul odours and vector attraction (Figure 55.2).

The severity of those negative impacts depends on the disposal technique. Land reclamation and agricultural recycling, discussed below, are two possible methods of land application.

Land reclamation. Large amounts of sludge are employed in the recovery of degraded areas, either those resulting from inadequate agricultural handling or

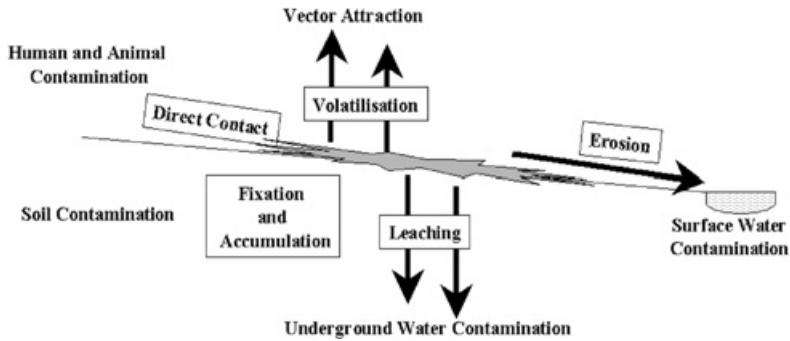

Figure 55.2. Direct impacts of sludge disposal on soil

from extractive activities, increasing the amounts of undesirable elements in soil, depending upon sludge characteristics. When applying high rates of sludge on land, careful analysis of imbalances that may occur between soil nutrients and leached nitrates is required.

Degraded areas are not structurally defined, typically presenting top and sub-surface layers mixed up, and having direct influence of climatic variations which may increase the susceptibility to erosion and leaching. As public access to those often-distant areas is restricted, odours and vectors are less significant items. Should erosion be a serious consideration on a particular degraded area, application of high rates of sludge is inappropriate, because this may lead to deterioration of run-off quality.

Agricultural land application. The main impacts of agricultural recycling are associated with the contamination hazards by toxic elements and pathogens, since both may affect environmental quality and public health. Applied rates should be based on crop nitrogen demand to avoid leaching and nitrates to the water table. Especially in case of lime-treated sludges, pH control to reach the desired level is important, together with nutrients balance in sites with continuous application. These risks are minimised through careful selection of the application sites, considering sludge, soil and physical characteristics, aiming to control:

- toxic elements and pathogenic organisms (accumulation and fixation) input
- natural dispersion mechanisms (storm run-off and leaching)
- indirect contamination (population and water-bodies vicinity, animal grazing and edible crops contamination)
- nutrients balance

55.3 MONITORING INDICATORS AND PARAMETERS

Accomplishment of an efficient monitoring relies on suitable environmental indicators. Each sludge disposal method has an appropriate indicator for impact assessment of the selected alternative. For instance, monitoring water quality may

Table 55.2. Main indicators related with impacts of sewage sludge disposal

Impact	Indicators
Water pollution	<ul style="list-style-type: none"> • changes in water quality • concentration of contaminants (toxic compounds and pathogens) • bioindicator species of environmental quality
Air pollution	<ul style="list-style-type: none"> • presence of gases and toxic substances • presence of particulates • odours
Soil pollution	<ul style="list-style-type: none"> • changes in physical, chemical and biological soil properties • concentration of contaminants (toxic compounds and pathogens)
Transmission of diseases	<ul style="list-style-type: none"> • pathogens density in soil • vectors attractiveness on application site (rodents and insects) • pathogenic organisms and toxic compounds concentration in crops
Food chain contamination	<ul style="list-style-type: none"> • concentration of contaminants in water, soil and crops • disturbances in wildlife communities • bioindicator species
Aesthetic and social problems	<ul style="list-style-type: none"> • acceptability in disposal area neighbourhood • consumers and producers acceptability of goods from sludge-amended areas • properties depreciation near sludge disposal sites

be more suitable and relevant for a particular disposal alternative than odour emission. Obviously, both must be monitored, but the impact on water quality resources has greater magnitude and importance than foul odours, since it potentially affects more people. Table 55.2 presents the main indicators related with the impacts of sewage sludge disposal alternatives.

Analytical parameters must be defined for each indicator to provide quantitative and qualitative data in the monitoring process that may lead to conclusions on the practice being carried out for sludge disposal. The selection of proper indicators and monitoring parameters depends on the adopted disposal alternative, sludge characteristics, monitoring objectives and requirements of local environmental legislation. Parameters used for water, soil and crop monitoring of sludge disposal sites are shown in Table 55.3.

Microbial soil communities can also be employed as monitoring parameters. According to Lambais and Souza (2000), both microbial soil biomass and its metabolic activities which can change the microbial communities may be affected by potentially pollutant agents, implying that such parameters may be useful for environmental impacts assessment and soil quality monitoring. Cardoso and Neto (2000) suggest the following parameters: CO₂ release, carbon biomass, enzymatic activity, counting of nitrogen-fixing microorganisms and mineralisation of nitrogen.

Table 55.3. Typical physical and chemical parameters for sludge disposal sites monitoring

Source	Parameters
Groundwater	pH, conductivity, total hardness, total dissolved solids, sulphates, total organic carbon, nitrate, nitrogen, total phosphorus, surfactants, metals or trace organics selected as necessary, indicator organisms
Surface water	Faecal coliforms, total phosphorus, total Kjeldahl nitrogen, dissolved oxygen, BOD, temperature, pH, suspended solids
Soil	Nitrates, total nitrogen, phosphorus, pH, conductivity, organic carbon, exchangeable cations (calcium, magnesium, potassium, sodium), metals (lead, mercury, chromium, cadmium, copper, nickel, zinc), CEC (Cation Exchange Capacity), texture, other components ¹
Crop	Metals (lead, mercury, chromium, cadmium, copper, nickel, zinc), macronutrients (NPK), other components ¹

¹ Other components, such as As, Fe, Mo, Se, PCBs, DDT and Dieldrin, must be analysed only if there are reasons to believe that significant quantities may be present in the sludge.

Source: Adapted from Granato and Pietz (1992)

55.4 MONITORING PLAN

Monitoring plans are useful instruments to control and assess the efficacy of the entire sludge disposal operation. They allow (a) to control and supervise impacts, (b) to follow the implementation and execution of the control measures, (c) to adjust, calibrate and validate models and parameters, and (d) to serve as reference for future studies monitoring propositions.

Monitoring responsibilities must be defined among the various parties involved: environmental agency, entrepreneur, other governmental and departmental agencies and the affected community.

Monitoring efficacy will depend on a plan identifying impacts, indicators and parameters, sampling frequencies, sampling points and analytical methods, leading to comparative and publishable results. The following elements are necessary while preparing a monitoring plan:

Monitoring goals. Clear and objective statement on monitoring purposes as a function of the selected final disposal alternative and possible related impacts.

Review of existing data. Encompasses a description of the selected alternative, characteristics of the disposal area(s), evaluation of the impacts and sludge characteristics. All information gathered on the final disposal site prior to process start-up may suit as future reference for comparison purposes. These tests prior to sludge application should be undertaken on the possible sources of concentration of contaminants (air, water, soil).

Definition of impacts. Relates to the potential consequences (impacts) the proposed activity may have upon the environment.

Selection of impact indicators. There is no list of applicable parameters for all cases. The legal requirements established for different kinds of wastes disposal in each region may serve as groundwork for choosing parameters. Existent constituents in sludge which may be present in concentrations that may deteriorate environment quality should be necessarily monitored.

Critical levels. Environmental critical levels allow the interpretation and assessment of the impact intensity, and may be either single figures or range limits.

Analytical and data collection methodology. Selection of laboratory sampling methods and procedures should consider the capability of existent laboratories near the disposal area, the parameters to be analysed and the size of the total disposal area. Sampling methodology must guarantee representativeness of the indicator, and the analytical procedures must be defined and calibrated to produce reliable data within a pre-defined accuracy.

Sampling points. Data should be collected where the occurrence of an impact is more likely to occur, allowing characterisation of the areas with lower or higher alterations.

Monitoring frequency. Sampling frequency of the selected parameters should be defined for both the sludge and the disposal area, and should allow identification of critical periods within seasonal variations.

USA sludge regulation – USEPA 40CFR Part 503 (EPA, 1993) requires that land applied **sludge** be monitored for metals, density of pathogens and parameters indicating vector attraction reduction. Frequency of sampling is dependent on the quantity of biosolids applied during one year (Table 55.4). Table 55.5 presents the monitoring frequency requirements established for the Brazilian State of Paraná, which has a large programme of biosolids recycling.

Monitoring frequency for the **sludge disposal areas** must be determined through assessment of the effects of the application to structure a database with the information gathered from each application site. A sampling network should be established on the application site and surroundings, defining sampling points

Table 55.4. Monitoring frequency for pollutants, pathogen density and vector attraction reduction (USEPA 40CFR Part 503)

Amount of biosolids land applied (tonne/year) – dry basis	Frequency
0–290	Once a year
290–1,500	Four times a year
1,500–15,000	Six times a year
≥15,000	Once a month

Source: EPA (1993)

Table 55.5. Sampling frequency for characterisation of biosolids for agriculture recycling (Paraná State, Brazil)

Biosolid land application (tonne/year) – dry basis	Frequency
<60	Once a year (prior to the highest demand harvest)
60–240	Every 6 months (once before summer harvest and another before winter harvest)
>240	Every biosolid lot of 240 tonne (dry matter) or every semester (whichever comes first)

Source: Fernandes *et al.* (1999)

Table 55.6. Monitoring frequency for wastewater sludge monofills and dedicated land disposal (DLD) sites

Parameter	Sludge		Groundwater ¹		Soil ²	
	Unit	Frequency	Unit	Frequency	Unit	Frequency
Total nitrogen	mg/kg	Monthly	mg/L	quarterly	mg/kg	quarterly
Nitrate nitrogen	mg/kg	Monthly	mg/L	quarterly	mg/kg	quarterly
Ammonia nitrogen	mg/kg	Monthly	mg/L	quarterly	mg/kg	quarterly
Phosphorus	mg/kg	Quarterly	mg/L	quarterly	mg/kg	2/month
Potassium	mg/kg	Quarterly	mg/L	quarterly	mg/kg	2/month
Cadmium	mg/kg	Quarterly	mg/L	quarterly	mg/kg	2/month
Lead	mg/kg	Quarterly	mg/L	quarterly	mg/kg	2/month
Zinc	mg/kg	Quarterly	mg/L	quarterly	mg/kg	2/month
Copper	mg/kg	Quarterly	mg/L	quarterly	mg/kg	2/month
Nickel	mg/kg	Quarterly	mg/L	quarterly	mg/kg	2/month
pH	–	Monthly	–	quarterly	–	quarterly
PCB	mg/kg	Yearly	mg/L	yearly	mg/kg	yearly
Water level	–	–	Meter	quarterly	–	–
CEC	–	–	–	–	meq/100g	quarterly

¹ One well each 20 ha of DLD

² One sample at 15 cm, 45 cm and 75 cm for each 8 ha of DLD

Source: Griffin *et al.* (1992)

including all possible media (air, water, soil, and crops), depending on the selected disposal alternative.

Wastewater sludge monofills and dedicated land disposal (DLD) sites might be monitored as advised by Griffin *et al.* (1992) (Table 55.6). The authors still recommend monthly monitoring of gas collection points in landfills with a portable gas detector, increased to weekly verifications if high levels of gases are identified.

For reclamation of **degraded areas**, Gschwind and Pietz (1992) present a minimum list of parameters, which should be included in routine water, soil and vegetation laboratory analyses (Table 55.7).

Data tabulation, analysis and evaluation. The analytical results could lead to a database with detailed information from the sludge disposal site, supported by a geo-referenced system.

Table 55.7. Minimum sampling procedure in degraded areas

Sample	Procedure
Water	<ul style="list-style-type: none"> • Collect at least three samples from every groundwater well and lysimeter station, prior to sludge application • Collect monthly water samples, after the application of sludge, during one year • For samples prior to sludge application and for those corresponding to the first three months after application, pH, Cl, NO₃-N, NH₄-N, Org-N, Fe, Al, Mn, Cu, Cr, Co, Pb, Cd, Ni, Zn and faecal coliforms should be analysed • From the 4th to the 11th month after application, only pH, NO₃-N, NH₄-N, Zn, Cu, Pb, Co, Ni, Cd, Cr and faecal coliforms should be analysed • In the 12th month after application, pH, Cl, NO₃-N, NH₄-N, Org-N, Fe, Al, Mn, Cu, Cr, Co, Pb, Cd, Ni, Zn and faecal coliforms should be analysed • Water sampling may end after one year, unless if $\frac{3}{4}$ of the data indicate that the process should continue. If more sampling is needed, the samples should be collected quarterly until sufficient data is gathered to allow conclusions • Monitoring of wells should continue after the first year to corroborate the data acquired in the last data collection
Soil	<ul style="list-style-type: none"> • Soil samples should be collected before sludge application. Surface samples should be collected at several points and analysed for pH, verifying whether liming is needed to raise pH level up to 6.5. Also soil CEC (Cation Exchange Capacity) should be determined. Samples from soil profile must be collected from pits excavated for lysimeters at 0–15 cm, 15–30 cm, 30–60 cm and 60–90 cm depths • One year after sludge application, soil samples should again be collected at 0–15 cm, 15–30 cm, 30–60 cm depths • All soil samples must be analysed for pH, P, Ca, Mg, K, Na, Fe, Al, Mn, Cu, Zn, Cr, Co, Pb, Cd, Ni and N Kjeldahl • Two years after application, the topsoil should once more be analysed for pH to check whether it still remains below 6.5
Vegetation	<ul style="list-style-type: none"> • Foliar samples should be analysed by the end of the growing season, after biosolid application. Separate samples from each planted species must be collected and analysed for N, P, K, Ca, Mg, Fe, Al, Mn, Cu, Zn, Cr, Co, Pb, Cd and Ni • For sown sites in fall seasons, vegetation samples should be collected at the end of the next season

Source: Gschwind and Pietz (1992)

Data analysis is essential in the decision-making process of whether a particular sludge disposal site should continue to be used, and provides useful input related to corrective measures that might be taken to achieve the desired programme goals. Furthermore, the analysis should also contribute to a better assessment of the parameters effectiveness and suitability of the analytical methods being used.

Maximum allowable concentrations for pollutants are useful as references for data interpretation. However, it should be borne in mind that specific legislations

reflect local or regional characteristics, and may not be widely applicable in every country or region. The best approach would be for each region to develop its own studies aiming at soil characteristics identification to establish proper legal parameter values.

Reports. The entity in charge of the final sludge disposal must establish a sound relationship with the community and environmental agencies, especially those in the surroundings of the sludge disposal area. Periodical reports should be sent to environmental agencies, showing clearly and objectively the interpreted monitoring results. This helps to build a historical database, open for public consultation. The reports and analytical results should be filed in the sludge-generating site, for occasional inspection by environmental protection agencies.

Information to population. The involved community should have access to any relevant information about environmental impacts such as to guarantee the transparency of the process.

Final remarks. Monitoring should be viewed as an integral part of the final sludge disposal process, since every alternative may potentially affect air, soil, water and crop quality.

The joint participation of the community and environmental agencies in all stages of the process, from the conception of the disposal project to the execution of its monitoring, allows improvements and control over the process, minimising possible negative impacts from the selected sludge disposal alternatives.

A monitoring plan is a dynamic instrument within the process, and in constant improvement from the very beginning of its implementation, because it is fed by the analysis of the results obtained and moves forward by the continuous research progress on sludge beneficial uses and disposal.

Part Seven

References

- ABNT (1989). *Projeto de estações de tratamento de esgotos* (in Portuguese), NB 570, Associação Brasileira de Normas Técnicas.
- ABNT (1992) NBR 8,419 (in Portuguese), Associação Brasileira de Normas Técnicas, Rio de Janeiro.
- ABNT (1997) *Tratamento no solo (landfarming)* (in Portuguese). NBR 13,894, Associação Brasileira de Normas Técnicas, Rio de Janeiro.
- ADEME (1998) *Connaissance et maîtrise des aspects sanitaires de l'épandage des boues d'épuration des collectivités locales*.
- Agrodevelopment, S.A. (1995) *Elaboração do plano piloto para gestão e reciclagem agrícola de lodo da ETE-Belém* (in Portuguese). Harry, J. Convênio de cooperação técnica SANEPAR – Governo Francês.
- Aisse, M.M., Van Haandel, A.C., Von Sperling, M., Campos, J.R., Coraucci Filho, B., Alem Sobrinho, P. (1999) Tratamento final de lodo gerado em reatores anaeróbios. In *Tratamento de esgotos sanitários por processo anaeróbio e disposição controlada no solo* (coord. J.R. Campos) pp. 271–300 (in Portuguese), PROSAB.
- Andreoli, C.V., Barreto, C.G., Bonnet, B.R.P. (1994) Tratamento e disposição final do lodo de esgoto no Paraná (in Portuguese). *Sanare*, **1**(1), 10–15.
- Andreoli, C.V., Pegorini, E.S. (1999) Distribution plans and legal permission requirements for land application of biosolids in Paraná, Brazil. In *IAWQ Specialized Conference on Disposal and Utilization of Sewage Sludge*, 71–78.
- Andreoli, C.V., Lara, A.I., Fernandes, F. (1999) *Reciclagem de biossólidos – Transformando problemas em soluções* (ed. Sanepar) (in Portuguese).
- Andreoli, C.V., Von Sperling M., Fernandes, F. (2001) Lodo de esgotos: tratamento e disposição final. *UFMG – Sanepar* (in Portuguese) 484 pp.
- Ayres, R.M., Lee D.L., Mara, D.D., Silva, S.A. (1994) The accumulation, distribution and viability of human parasitic nematode eggs in the sludge of a primary facultative waste stabilization pond. *Trans. R. Soc. Trop. Med. Hyg.* **87**, 256–258.
- Berron, P. (1984) Valorisation agricole des boues d'épuration: aspects micro biologiques, *ISM*, **11**, 549–556.
- Brown, L. (1993) *Qualidade de vida – Salve o planeta*. São Paulo: (ed. Globo) (in Portuguese).

- Cardoso, E.J.B.N., Fortes Neto, P. (2000) Aplicabilidade do biossólido em plantações florestais: III Alterações microbianas no solo. In *Impacto ambiental do uso agrícola do lodo de esgoto*. BETTIOL, W. e CAMARGO, O.A. (orgs). Jaguariúna, SP: EMBRAPA Meio Ambiente, p. 197–202 (in Portuguese).
- CEMAGREF (1990) *Les systèmes de traitement de boues des stations d'épuration des petites collectivités*. Documentation technique, FNDAE 9, 85. Centre National du machinisme agricole du génie rural des eaux et des forêts, Paris.
- CETESB (1985) *Resíduos sólidos industriais*. Série Atas da Cetesb, São Paulo: CETESB/ASCETESB (in Portuguese).
- Chernicharo, C.A.L. (1997) *Princípios do tratamento biológico de águas residuárias. Vol. 5. Reactores anaeróbios*. DESA-UFGM. 245 pp (in Portuguese).
- CIWEM (The Chartered Institution of Water and Environmental Management) (1996) Sewage sludge – Utilization and disposal. In *Handbook of UK Wastewater Practice*, 110 pp.
- CIWEM (The Chartered Institution of Water and Environmental Management) (1999) Sewage sludge – Conditioning, dewatering, thermal drying and incineration. In *Handbook of UK Wastewater Practice*, 110 pp.
- Crites, R., Tchobanoglous, G. (2000) *Tratamiento de aguas residuales en pequeñas poblaciones* (in Spanish), McGraw-Hill, Colombia.
- Da Silva, S.M.C.P., Fernandes, F., Soccol, V.T., Morita, D.M. Principais contaminantes do lodo (2001) In *Princípios do tratamento biológico de águas residuárias. Vol. 6. Lodo de esgotos. Tratamento e disposição final* (in Portuguese) (eds. C.V. Andreoli, M. Von Sperling, M., F. Fernandes), p. 484, Departamento de Engenharia Sanitária e Ambiental – UFGM. Companhia de Saneamento do Paraná – SANEPAR.
- EPA (1979) *Process Design Manual – Sludge Treatment and Disposal*. U.S. Environmental Protection Agency.
- EPA (1983) *Land Application of Municipal Sludge – Process Design Manual*. EPA/625/1–83–016, United States Environmental Protection Agency, Cincinnati.
- EPA (1987) *Design Manual – Dewatering Municipal Wastewater Sludges*. EPA/625/1–87/014, United States Environmental Protection Agency.
- EPA (1990) *Autothermal Thermophilic Aerobic Digestion of Municipal Wastewater Sludge*. EPA/625/10–90/007, United States Environmental Protection Agency.
- EPA (1992) *Control of Pathogens and Vector Attraction in Sewage Sludge Under 40 CFR part 503*. Office of Water, Office of Science and Technology Sludge Risk Assessment Branch. Washington, DC.
- EPA (1992) *Control of Pathogens and Vector Attraction in Sewage Sludge*. EPA/625/R–92/013, United States Environmental Protection Agency.
- EPA (1993) *Land Application of Biosolids – Process Design Manual*. United States Environmental Protection Agency, Cincinnati.
- EPA (1994) *A Plain English Guide to the EPA Part 503 Biosolids Rule*. EPA/832/R–93/003, United States Environmental Protection Agency.
- EPA (1995) *A Guide to the Biosolids Risk Assessments for the EPA Part 503 Rule*. EPA/832/B–93/005, United States Environmental Protection Agency.
- EPA (1999) *Biosolids Generation, Use and Disposal in the United States*. EPA/530/R–99/009, United States Environmental Protection Agency.
- European Environmental Agency (1997) Sludge treatment and disposal. *Environmental Issues Series*. p.52.
- Feix I., Wiart J. (1998) *Les agents pathogènes. Connaissance et maîtrise des aspects sanitaires de l'épandage des boues d'épuration des collectivités locales*, ADEME, p. 75.
- Fernandes, F. (1999) *Relatório PROSAB 01, Tema 4*. Universidade Estadual de Londrina (in Portuguese).
- Fernandes, F., Lara, A.I., Andreoli, C.V., Pegorini, E.S. (org.) (1999) Normatização para a reciclagem agrícola do lodo de esgoto. In *Reciclagem de biossólidos: transformando*

- problemas em soluções*, (coord. C.V. Andreoli, A.I. Lara, F. Fernandes), pp. 263–291, Curitiba. Sanepar/Finep. (in Portuguese).
- Fernandes, F., Silva, S.M.C.P. (1999) *Manual prático para compostagem de biossólidos*. PROSAB – Programa de Pesquisa em Saneamento Básico – ABES, Rio de Janeiro, 84 p (in Portuguese).
- Fernandes, F. (2000) Estabilização e higienização de biossólidos. In *Impacto ambiental do uso agrícola do lodo de esgotos*. (ed. Embrapa Meio Ambiente) (in Portuguese).
- Ferreira Neto, J.G. (1999) *Fluxograma ETE Brasília Norte e ETE Brasília Sul* (in Portuguese).
- Gaspard P.G., Schwartzbrod J. (1995) Helminth eggs in wastewater: quantification technique. *Wat. Sci. Technol.* **31**(5/6), 443–446.
- Gaspard P.G., Wiart J., Schwartzbrod J. (1996) A method for assessing the viability of nematode eggs in sludge. *Environ. Technol.* **17**, 415–420.
- Gómez, J.S. (1998) *Impacto ambiental em rellenos sanitarios*. Asociación Mexicana para el Control de los Residuos Sólidos Peligrosos. (in Spanish).
- Gonçalves, R. (1996) Sistemas aeróbios com biofilmes. In *Seminário internacional. Tendências no tratamento simplificado de águas residuárias domésticas e industriais*. (Anais). Belo Horizonte (**6/8**), 128–143 (in Portuguese).
- Gonçalves, R. (coord) (1999) *Gerenciamento do lodo de lagoas de estabilização não mecanizadas*. PROSAB. (in Portuguese).
- Granato, T.C., Pietz, R.I. (1992) Sludge application to dedicated beneficial use sites. In *Municipal Sewage Sludge Management: Processing, Utilization and Disposal*, (eds. C. Lue-Hing, D.R. Zens and R. Kuchenrither) Water Quality Management Library, **4**, 417–454.
- Griffin, R.A. Lue-Hing, C., Sieger, R.B., Uhte, W.R., Zenz, D. (1992) Municipal sewage sludge management at dedicated land disposal sites and landfills. In *Municipal sewage sludge management: processing, utilization and disposal*, (eds. C. Lue-Hing, D.R. Zens and R. Kuchenrither) Water Quality Management Library, **4**, 299–376.
- Gschwind, J., Pietz, R.I. (1992) Application of municipal sewage sludge to soil reclamation sites. In *Municipal Sewage Sludge Management: Processing, Utilization and Disposal* (eds. C. Lue-Hing, D.R. Zens and R. Kuchenrither). Water Quality Management Library, **4**, 455–478.
- Hall, J.E. (1998) Standardizing and the management of biosolids – The international experience. In *Anais do I Seminário sobre Gerenciamento de Biossólidos no Mercosul*, Curitiba-PR, pp. 113–122.
- Helou, L.C. (2000) *Otimização de estações de tratamento de esgotos convencionais por lodos ativados com aproveitamento dos efluentes para reúso*. São Paulo, out/2000. Tese (doutorado) – Escola Politécnica, Universidade de São Paulo. 265 p (in Portuguese).
- Hess, M.L. (1973) *Lagoas de estabilização*. Capítulo 6: lagoas anaeróbias. CETESB, São Paulo, 2nd edn (in Portuguese).
- Imhoff, K. (1966) *Manual de tratamento de águas residuárias*. Editora da Universidade de São Paulo (in Portuguese).
- JICA (1993) *Textbook for the Group Training Course in Sewage Works Engineering*, vol. III.
- Jordão, E.P., Pessoa, C.A. (1995) *Tratamento de esgotos domésticos*. ABES, 3rd edn, p. 683 (in Portuguese).
- Kiehl, E.J. (1985) *Fertilizantes orgânicos*. Piracicaba: Agronômica Ceres (in Portuguese).
- Lambais, M.R., Souza, A.G. (2000) *Impacto de biossólidos nas comunidades microbianas do solo*. In: BETTIOL, W., CAMARGO, O.A. (orgs.). Jaguariúna, SP: EMBRAPA Meio Ambiente, 2000. pp. 269–280 (in Portuguese).
- Lashof, D.A., Lipar, D.A. (1989) *Policy Options for Stabilizing Global Climate*. Draft report to congress. EPA, Washington, DC.
- Loehr, R.C. Environmental impacts of sewage sludge disposal. In *Sludge and Its Ultimate Disposal* (ed. J.A. Borchardt. Ann Arbor Science. 179–210.

- Ludovice, M. (2000) Experiência da Companhia de Saneamento do Distrito Federal na reciclagem de biossólido. In: *Impacto ambiental do uso agrícola do lodo de esgoto*. ed. BETTIOL e CAMARGO. Jaguariúna, SP: EMBRAPA Meio Ambiente. 312 p (in Portuguese).
- Malina, J.F. (1993a) Sludge treatment and disposal. In *II Seminário de Transferência de Tecnologia*. ABES, Rio de Janeiro.
- Malina, J.F. (1993b) Effectiveness of municipal sludge treatment processes in eliminating indicator organisms. In *Joint Residuals Conference*, AWWA/WEF, Arizona.
- Medeiros, M.L.B., Thomaz Soccol, V., Castro, E.A., Toledo, E.B., Borges, J., Paulino, R., Andraus S. (1999) Aspectos Sanitários. In *Reciclagem de biossólidos. Transformando problemas em soluções*. pp. 120–179 (in Portuguese).
- Melo, W.J., Marques, M.O. (2000) Potencial do lodo de esgoto como fonte de nutrientes para as plantas. In *Impacto ambiental do uso agrícola do lodo de esgoto*. Bettiol, W. e Camargo, O.A. (coord.), Jaguariúna: EMBRAPA Meio Ambiente, pp. 109–141 (in Portuguese).
- Melo, W.J., Marques, M.O., Santiago, G. (1993) Efeito de doses de lodo de esgoto sobre a matéria orgânica e a CTC de um latossolo cultivado com cana. In *Congresso Brasileiro de Ciência do Solo* (24.:1993: Goiânia). Anais . . . Brasília: SBCS, vol. 2, pp. 253–254 (in Portuguese).
- Metcalf and Eddy (1991) *Wastewater Engineering: Treatment, Disposal, Reuse*, Metcalf and Eddy Inc., Mac Graw Hill, New York.
- Morita, D.M. (1993) Tratabilidade de águas residuárias contendo poluentes perigosos- estudo de caso. Tese (doutorado), Escola Politécnica, Universidade de São Paulo, (in Portuguese).
- Muller, P.S.G. (1998) Caracterização físico-química, microbiológica e estudos de desidratação em leite de secagem de lagoas de estabilização. Dissertação de mestrado, UFES, Vitória-ES (in Portuguese).
- Nogueira, R., Santos, H.F. (1995) *Cobertura final de células de lodo com solo – Um ensaio realizado – III Simpósio sobre barragens de rejeitos e disposição de resíduos – REGEO'95*, Ouro Preto, MG (in Portuguese).
- Oorschot, R. Van, Waal, D., Semple, L. (2000) Options for beneficial reuse of biosolids in Victoria. *Wat. Sci. Technol.* **41**(8), 115–122.
- Outwater, A.B. (1994) *Reuse of Sludge and Minor Wastewater Residuals*. S.1.: Lewis Publishers.
- Passamani, F.R.F., Motta, J.S., Figueiredo, Gonçalves, R.F. (2000) Pasteurização do lodo de um reator UASB na remoção de coliformes fecais e ovos de helmintos. In *I Seminário Nacional de Microbiologia Aplicada ao Saneamento*, pp. 251, 5–7 Junho 2000, Vitória, Espírito Santo. (in Portuguese).
- Passamani, F.R.F., Gonçalves, R.F. (2000) Higienização de lodos de esgotos. In *Gerenciamento de lodos de lagoas de estabilização não-mecanizadas*. Ed. ABES – PROSAB (in Portuguese).
- Qasim, S.R. (1985) *Wastewater Treatment Plants: Planning, Design and Operation*, Holt, Rinehart and Winston.
- Raij, B. van (1998) Uso agrícola de biossólidos. In *I Seminário sobre Gerenciamento de Biossólidos do Mercosul* (anais), Curitiba: SANEPAR/ABES pp. 147–151 (in Portuguese).
- SANEPAR (Companhia de Saneamento do Paraná) (1997) *Manual técnico para utilização agrícola do lodo de esgoto no Paraná*. Curitiba: SANEPAR (in Portuguese).
- SANEPAR (Companhia de Saneamento do Paraná) (1997) *Reciclagem agrícola do lodo de esgoto: estudo preliminar para definição de critérios para uso agrônomico e de parâmetros para normatização ambiental e sanitária*. Curitiba: SANEPAR (in Portuguese).
- SANEPAR (Companhia de Saneamento do Paraná) (1999) *Uso e manejo do lodo de esgotos na agricultura*. ed. PROSAB/FINEP (in Portuguese).

- Santos, H.F. (1979) *Aplicação do lodo de estações de tratamento de esgotos em solos agrícolas*, Revista DAE, 122, pp. 31–48 (in Portuguese).
- Santos, H.F. (1996) *Uso agrícola do lodo das estações de tratamento de esgotos sanitários (ETE's): Subsídios para elaboração de uma norma brasileira*. Dissertação para obtenção do grau de mestre em Saneamento Ambiental, Universidade Mackenzie, SP São Paulo (in Portuguese).
- Sapia, P.M.A. (2000) *Proposta de critérios de recebimento de efluentes não-domésticos para o sistema público de esgoto da Região Metropolitana de São Paulo*. Dissertação (mestrado), Escola Politécnica, Universidade de São Paulo (in Portuguese).
- Schwartzbrod, J., Mathieu, C., Thevenot, M.T., Baradel, J.M., Schwartzbrod, L. (1990) Sludge parasitological contamination. In *Treatment and use of sewage sludge and liquid agricultural wastes* (ed. L'Hermitte). Congrès d'Athènes (GR), 1–4 Oct 1990, Elsevier Appl. Sci.
- Silva, J.E., Dimas, V.S.R., Sharma, R.D. (2000) Alternativa agrônômica para o biossólido: a experiência de Brasília. In *Impacto ambiental do uso agrícola do lodo de esgoto*. Bettiol, W. e Camargo, O.A. (coord.), Jaguariúna: EMBRAPA Meio Ambiente, pp. 143–162 (in Portuguese).
- Souza, M.L.P., Andreoli, C.V., Pauletti, V. (1994) Desenvolvimento de um sistema de classificação de terras para disposição final do lodo de esgoto. In *Simpósio Luso-Brasileiro de Engenharia Sanitária e Ambiental*, vol.1, tomo 1, pp. 403–419 (in Portuguese).
- Thomaz Soccol, V. (2000) Riscos de contaminação do agrossistema com parasitos pelo uso de lodo de esgoto. In *Impacto ambiental do uso agrícola do lodo de esgoto*. ed. BETTIOL e CAMARGO. Jaguariúna, SP: EMBRAPA Meio Ambiente. 312 p.
- Thomaz Soccol, V., Paulino, R.C., Castro, E.A. (1997) Helminth eggs viability in sewage and biosolids sludge in Curitiba, Parana, Brazil. *Brazilian Arch. of Biol and Technol.* 40(4), 829–836.
- Thomaz Soccol, V., Paulino, R.C., Castro, E.A. (2000) Metodologia para análise parasitológica em lodo de esgoto. In *Manual de métodos para análises microbiológicas e parasitológicas em reciclagem agrícola de lodo de esgoto*. Andreoli and Bonnet, Curitiba, 2nd edn. rev e ampl. 28–41 (in Portuguese).
- Tsutya, M.T. (2000) Alternativas de disposição final de biossólidos gerados em estações de tratamento de esgotos. In *Impacto ambiental do uso agrícola do lodo de esgoto*. BETTIOL, W. e CAMARGO, O.A. (coord.), Jaguariúna: EMBRAPA Meio Ambiente, p. 69–105 (in Portuguese).
- UEL (1999) *Manual prático para compostagem de biossólidos*. ed. PROSAB/FINEP (in Portuguese).
- Van Haandel, A.C., Lettinga, G. (1994) *Anaerobic Sewage Treatment: A Practical Guide for Regions with a Hot Climate*, John Wiley and Sons.
- WEF (Water Environment Federation) (1992) Sludge incineration: Thermal destruction of residues. *Manual of Practice*. FD–19.
- WEF (Water Environment Federation) (1996) Operation of municipal wastewater treatment plants. *Manual of Practice*. 11.
- WEF/ASCE (Water Environment Federation/American Society of Civil Engineers) (1992) *Design of municipal wastewater treatment plants*.
- WHO (World Health Organization) (1989) *Health Guidelines for the Use of Wastewater in Agriculture and Aquaculture*. Technical Report Series 778 (Geneva, 1989).
- WPCF (Water Pollution Control Federation) (1991) Operation of municipal wastewater treatment plants. *MOP 11* (III).

Index

- A²O process, 1014, 1016
- acetate-using microorganisms, 666
- acetoclastic methanogens, 666, 671
 - Methanosaeta* genera, 666
 - Methanosarcina* genera, 666
- acetogenic bacteria, 665, 666, 1220, 1221
- acetotrophic methanogenesis, 303, 304
- acid-producing bacteria, 688
- acidifiable COD, 672
- acidification, 555
- acidogenesis, 665
- acidogenic bacteria, 541, 666, 668, 1220, 1221. *See also* methanogenic microorganisms
- activated sludge, 111, 237, 839
 - conventional, 173
 - extended aeration, 173, 206
 - floc, 841
 - for post-treatment of anaerobic effluent, 848, 1042, 1045
 - intermittently operated activated sludge, 173
 - recirculation, 872
 - sedimentation tank. *See* activated sludge sedimentation tanks
 - with biological nitrogen and phosphorus removal, 174, 209, 210, 211
- activated sludge process
 - MLSS, 856
 - MLVSS, 856, 859
 - organic matter removal, 855
 - biodegradable solids, 869, 871
 - BOD, 868
 - excess sludge, 881, 887
 - nitrogen, 898
 - substrate removal, 862
 - volatile biodegradable solids, 869
 - volatile solids, 871
 - variables in, 856
- activated sludge process variants
 - comparison between, 848, 850
 - flow based division
 - continuous, 843, 844
 - intermittent, 843, 846
 - influent based division
 - effluent from anaerobic reactor, 843
 - effluent from primary sedimentation tank, 843
 - effluent from wastewater treatment process, 843
 - raw sewage, 843
 - sludge age based division
 - conventional, 843, 844, 849, 857
 - extended aeration, 843, 845, 849, 857
 - UASB-activated sludge system, 848, 849
- activated sludge reactor
 - continuous flow, 906
 - design, 908, 912
 - for organic matter removal, 907, 908
 - physical configurations
 - Carrousel-type oxidation ditches, 909, 911, 913
 - complete-mix, 909, 910
 - Pasveer-type oxidation ditches, 909, 911, 913
 - plug-flow, 910, 912
 - step aeration, 910
 - sludge age selection aspects, 906
 - step feeding, 910
 - See also* activated sludge system

- activated sludge sedimentation tanks
 - design for clarification, 923
 - design for thickening, 923
 - design principles, 922
 - Dortmund tanks, 915
 - hydraulic loading rates, 916
 - primary, 939, 940
 - secondary, 916, 937
 - solids flux theory, 920
 - solids loading rates, 916
- activated sludge system, 178
 - alternated aeration, 1029
 - biochemical reactions, 840
 - biodegradable volatile removal, 871
 - biological solids production, 877
 - biomass concentration, 840
 - BOD removal, 845, 868
 - comparison with anaerobic UASB reactors, 841
 - configuration, 826
 - considerations, 826
 - continuous flow, 202, 839, 844–845, 855
 - conventional, 202, 204–206, 842, 844
 - cyclic (CASS), 1028
 - design criteria, 827
 - effluent BOD concentration, 863
 - effluent post-treatment, 842
 - excess sludge production, 877, 879
 - excess sludge removal, 881, 883
 - extended aeration, 202, 206
 - food/microorganism ratio, 841
 - for organic matter removal, 942
 - functional relations with sludge age, 897, 899
 - hydraulic control, 881
 - intermittent flow, 202
 - intermittent operation, 207
 - MCRT, 840
 - nutrient requirements, 893
 - operational problems, 1074
 - oxygen requirements
 - carbonaceous oxygen demand, 887
 - oxygen demand for nitrification, 892
 - particulate BOD in, 865, 867
 - reactor volume calculation, 859
 - recirculation, 354
 - relations with sludge age
 - oxygen consumption, 898
 - suspended solids production, 898
 - volatile solids production, 898
 - removal of carbon and nutrients, 202
 - sludge digestion, 869
 - sludge quality influencing factors, 874
 - sludge recirculation, 840
 - soluble effluent BOD, 863, 865
 - SRT, 840
 - substrate removal, 862
 - suspended BOD, 865
 - suspended solids
 - concentration, 857, 866
 - mass balance, 872
 - removal, 871
 - temperature influence, 896
 - total effluent BOD, 865
 - UASB-activated, 848, 849
 - VSS fraction, 865
 - VSS removal, 871
 - with intermittent operation, 846, 847
 - See also* activated sludge reactor; conventional activated sludge
- activated sludge system configuration
 - aeration tank, 839
 - excess sludge removal unit, 840
 - settling tank, 839
 - sludge recirculation unit, 840
- activated sludge system design for anaerobic effluents post-treatment
 - design example, 1045
 - design parameters
 - biological nutrient removal, 1044
 - for reactor, 1044
 - for secondary sedimentation tank, 1044
 - hydraulic loading rate, 1042
 - MLSS concentration, 1042, 1044
 - nitrification, 1044
 - secondary sedimentation system, 1042
 - sequencing batch activated sludge reactor, 1044
 - sludge age, 1042
 - solids loading rate, 1042
- model parameters and coefficients
 - aeration coefficients, 943
 - kinetic and stoichiometric parameters, 943
 - relation between solids, 943
 - See also* conventional activated sludge system design
- active autotrophic biomass, 371
- active biomass
 - active autotrophic, 371, 963
 - active heterotrophic, 370, 962
 - phosphorus fraction in, 994
 - See also* inert residue
- active decomposition zone, 83

- active heterotrophic biomass, 370
- adhesion index. *See under* population
 - forecast and sewage system
- adsorbed water removal, 1243, 1244
- adsorption
 - dissolved solids, 169
 - process for COD removal, 676
- advanced primary treatment, 181
- advection process in DO balance
 - mechanism, 86
- aerated lagoons
 - complete-mix. *See* complete-mix aerated lagoons
 - facultative. *See* facultative aerated lagoons
 - mechanical aerators and, 553
 - See also* stabilisation ponds
- aerated ponds
 - nitrogen removal efficiency, 611
 - operational problems, 643
- aerated static pile composting, 271, 1239, 1298
- aeration
 - aspects in composting, 1296
 - atmospheric reaeration, 86, 88
 - diffused air, 457, 471
 - level regulation methods, 1065
 - mechanical, 457, 474
 - rates (submerged aerated biofilter), 1151
 - tank, 204, 839
 - tests. *See* aeration tests
 - treated wastewater, 116
 - water body, 116
 - See also* aeration system
- aeration coefficients
 - oxygen transfer efficiency, 471
 - oxygenation efficiency, 470
 - power level, 472
- aeration kinetics
 - diffusion coefficient, 464
 - DO concentration
 - with oxygen consumption aeration, 466
 - without oxygen consumption aeration, 465
 - mass transfer coefficient, 464
 - oxygen transfer, 466
 - See also* gas transfer mechanisms
- aeration system
 - biological nitrogen removal systems
 - design criteria, 1005
 - for sequencing batch reactors design, 1033
 - for submerged aerated biofilters, 1148
 - intermittent cycle extended (ICEAS), 1029
- aeration tests, 478
 - clean water test
 - steady-state method, 480
 - unsteady-state method, 480
 - under operating conditions
 - steady-state method, 480
 - unsteady-state method, 480
- aerators, 187, 237, 474
- aerobic biofilm reactors, 174, 179, 211, 1113. *See also* aerobic reactors
- aerobic biological sludge, 247
- aerobic biological treatment
 - carbonaceous organic matter oxidation, 886
 - nitrogenous matter oxidation (nitrification), 886
- aerobic conversion of carbonaceous matter, 373
- aerobic digester, 1234–1236
 - thermophilic, 1239
 - See also* aerobic digestion; anaerobic digester
- aerobic digesters design parameters
 - hydraulic detention time, 1234
 - mixing, 1235
 - organic loading, 1234
 - oxygen demand, 1234, 1235
 - power requirements, 1234
 - temperature, 1235
- aerobic digesters operational performance parameters
 - digested sludge odour and aspect, 1235
 - sludge dewaterability, 1235, 1236
 - supernatant quality, 1235, 1236
 - volatile solids reduction, 1235, 1236
- aerobic digestion, 259–260, 1214
- autothermal thermophilic (ATAD), 1302
- composting, 1239
- conventional, 1234
- thermophilic, 272, 1238
- with pure oxygen, 1238
- See also* anaerobic digestion
- aerobic reactors
 - biofilm reactors, 211, 1113
 - classification
 - hybrid reactors, 1114
 - reactors with attached biomass, 1114
 - reactors with suspended biomass, 1114
 - high rate trickling filters, 174, 213

- aerobic reactors (*cont.*)
 - hydrodynamic conditions in, 1118
 - low rate trickling filter, 174, 211
 - mass transfer aspects, 1115
 - metabolic conversion processes, 1115
 - oxygen transfer aspects, 1115
 - rotating biological contactors, 215
 - submerged aerated biofilters, 214
 - systems with nitrification, 1118
 - See also* anaerobic reactors
- aerobic sludge digestion. *See* aerobic digestion
- aerobic sludges, 1320
- aerobic systems, 661. *See also* anaerobic systems
- aerobic treatment combined with anaerobic treatment, 809
- aerobic zone, 503. *See also* anaerobic zone; facultative zone
- agricultural land application, 1396
- agricultural occupation, 135
- agricultural recycling, 1396
- agricultural reuse based sludge disposal, 276
- agriculture
 - biosolids land application, 1345, 1356
 - biosolids nutrient concentrations
 - nitrogen, 1330
 - organic matter, 1331
 - phosphorus, 1331
 - soil conditioner, 1331
 - sewage sludge land application, 1329
- agriculture considerations for sludge processing
 - environmental constraints, 1321
 - pedological constraints, 1321
- agriculture, environmental aspects in
 - carbon fixation, 1333
 - erosion and natural resources control, 1333, 1334
- agronomic quality of biosolid, 1345
- air flotation, dissolved, 257, 1246
- air temperature influence on stabilisation ponds, 511
- algae, 34
 - ammonia assimilation by, 610, 611
 - blooms, 136
 - Chrysophyta*, 506
 - Cyanobacteria*, 505
 - Green algae*, 505
 - nitrate assimilation by, 610
 - phyla *Bacillariophyta*, 506
 - pigmented flagellated, 505
 - stratification influence, 509
- algae genera
 - Anabaena*, 506
 - Anacystis*, 506
 - Chlamydomonas*, 505
 - Chlorella*, 505
 - Euglena*, 505
 - Oscillatoria*, 506
 - Phormidium*, 506
- alkaline stabilisation
 - advantages and disadvantages, 1306
 - biosolids management and, 1336
 - design and operational aspects
 - industrial systems, 1307
 - simplified systems, 1307
 - dewatered sludges, 1306
 - for pathogen reduction, 1305
 - for sludge treatment, 1305
 - liquid sludges, 1305
 - operational troubleshooting, 1308
 - problems, 1309
 - technologies using alkaline agents, 1308
- alkalinity
 - anaerobic process, 691
 - anaerobic sludge digesters, 1230
 - based wastewater characteristics, 34
 - buffer capacity and, 689
 - monitoring, 691
 - requirements for nitrification, 976
 - supplementation, 692
 - volatile acids interaction, 690
- alternated aeration activated sludge system, 1029
- amictic lakes, 143
- ammonia concentration problem causes and control
 - high influent ammonia loads, 1102
 - insufficient MLSS concentration, 1102
 - nitrifying bacteria growth inhibition, 1101
- ammonia, 45, 369, 370
 - and organic nitrogen, 33
 - assimilation by algae, 610, 611
 - denitrification process and, 47
 - nitrification process and, 47
 - organic nitrogen and, 45
 - oxidation, 375
 - pH range for, 46
 - removal efficiency, 613
 - removal, 611
 - stripping, 610
 - toxicity, 694
 - See also* ammonification; Total Kjeldahl Nitrogen

- ammonia forms distribution
 - free, 45, 46, 47
 - ionized, 46, 47
- ammonification, 170, 369, 375
- Amoebas*, 310
- anabolism, 377. *See also* catabolism
- anaerobic bacteria, 540
- anaerobic biological sludge, 247
- anaerobic conversion of carbonaceous matter
 - acidogenic phase, 374
 - methanogenic phase, 374
- anaerobic conversion stages
 - acids formation, 541
 - liquefaction, 541
 - methane formation, 541
- anaerobic decay, 555
- anaerobic digester, 261
 - cylindrical, 1222
 - design, 1221
 - egg-shaped, 1222
 - heat balance features, 1227
 - low-rate, 711
 - mixing in, 1223
 - monitoring, 1233
 - one-stage high-rate, 712
 - operation and control aspects
 - CO₂ concentration in biogas, 1230
 - detention time, 1229
 - feeding frequency, 1229, 1231
 - methane production, 1230
 - pH and alkalinity, 1230, 1231
 - volatile acids concentration, 1230
 - two-stage high-rate, 713
 - See also* aerobic digester
- anaerobic digestion, 259–260, 1215
 - acetogenesis, 665
 - acidogenic microorganisms, 667
 - alkalinity monitoring, 691
 - alkalinity requirements, 688
 - biochemistry of, 667
 - biogas production aspects, 1224
 - COD balance, 671, 672
 - COD removal, 674
 - environmental requirements, 681
 - hydrolysis and acidogenesis, 665
 - intermediate volatile acids, 669
 - metabolic pathways, 664
 - metabolic pathways
 - (sulphate-reduction), 668
 - methane formation, 670
 - methane production estimation
 - considering chemical composition, 676
 - considering degraded COD, 677
 - methane production, 676, 680
 - methanogenesis, 666
 - methanogenic microorganisms, 667
 - microbial groups, 664
 - microbial groups (sulphate-reduction), 668
 - microbiology of, 664
 - nutrients requirements, 681
 - m micronutrients, 685
 - nitrogen, 683
 - phosphorus, 683
 - sulphur, 683
 - oxi-reduction reactions, 670
 - pathogens reduction aspects, 1221
 - pH requirements, 688
 - process description, 1219
 - reaction kinetics, 1219
 - sulphate reduction, 667, 680
 - temperature and heat balance, 1225
 - temperature requirements, 685
 - thermodynamic aspects, 669
 - toxic materials
 - ammonia, 694
 - metals, 696
 - salts, 693
 - sulphide, 694
 - volatile acids requirements, 688
 - wastewater characteristics, 671
 - wastewater degradation, 676
 - See also* aerobic digestion; anaerobic systems; anaerobic technology
- anaerobic digestion requisites
 - inhibiting substances, 1218
 - metals, 1218
 - preliminary treatment, 1217
 - solids concentration, 1218
- anaerobic digestion system
 - primary, 1224
 - secondary, 1224
- anaerobic effluent post-treatment
 - activated sludge for, 848, 1042
 - activated sludge system example, 1045
 - additional BOD removal, 617, 618, 619
 - nutrient removal, 617, 619
 - pathogenic organism removal, 617, 619
 - submerged aerated biofilters for, 1144
- anaerobic filters, 173, 198, 717
 - downflow, 729
 - effluent recirculation, 732
 - for effluent post-treatment, 811
 - upflow, 729

- anaerobic filters start-up
 - coarse solids removal, 792
 - grease removal, 792
 - sludge wastage, 793
- anaerobic organisms
 - acetogenic, 1219, 1220
 - acidogenic, 1220
 - characteristics, 1220
 - hydrolytic acidogenic, 1219
 - methanogenic, 1219, 1220
- anaerobic pond/facultative pond, 171, 496
- anaerobic ponds, 186, 715
 - bad odours generation, 541
 - BOD concentrations, 540
 - BOD removal efficiencies, 541, 545, 546
 - effluent BOD concentration, 541, 545
 - followed by facultative ponds, 541
 - for domestic sewage treatment, 540
 - helminth eggs removal, 604
 - operation start-up, 637
 - operational problems, 639
 - organic matter conversion, 540
 - sludge accumulation, 547
 - See also* stabilisation ponds
- anaerobic ponds design criteria
 - depth, 542, 545
 - detention time, 542, 544
 - geometry, 542, 545
 - volumetric organic loading rate, 542
- anaerobic reactors, 659
 - anaerobic filter, 198
 - biofilm reactors, 174
 - BOD removal, 617
 - effluent, 617
 - for effluents post-treatment, 805, 810
 - sedimentation tanks, 199
 - septic tank, 198
 - UASB, 198, 200
 - with internal recirculation, 725
 - See also* aerobic reactors
- anaerobic reactors monitoring
 - digester stability, 781
 - reactor efficiency, 780
 - sludge quantity and quality, 781
- anaerobic reactors design
 - anaerobic filters, 728
 - design criteria
 - efficiencies of anaerobic filters, 737
 - effluent distribution and collection systems, 736
 - hydraulic detention time, 734
 - hydraulic loading rate, 735
 - organic loading rate, 735
 - packing medium height, 734
 - sludge sampling and removal devices, 736
 - temperature, 734
 - effluent recirculation, 732
 - packing medium, 730
 - performance relationships, 732
 - reactor configuration, 729
 - UASB reactors, 740
 - upflow velocity, 732
- anaerobic reactors operational control
 - anaerobic filters operation, 792
 - foul odours prevention, 789
 - health and safety aspects, 776
 - importance of, 774
 - information aspects, 777
 - maintenance aspects, 777
 - operation aspects, 777
 - operational conditions optimisation, 775
 - operational parameters verification, 775
 - operational precautions, 790
 - operational troubleshooting, 799
 - influent flow characteristics, 800
 - preliminary treatment, 801
 - sludge drying beds, 804
 - sludge in reactor, 803
 - UASB reactor performance, 802
 - reactors start-up, 791
 - sludge measurement and characterisation, 785
 - sludge wastage aspects
 - excess sludge production, 786
 - excess sludge wastage, 787
 - system monitoring, 777
 - UASB reactors operation, 793
- anaerobic sewage treatment, 617
- anaerobic sludge blanket reactor, 617. *See also* UASB reactors
- anaerobic sludge digester. *See* anaerobic digester
- anaerobic sludges, 1320
- anaerobic systems, 177, 661, 662
 - advantages and disadvantages, 660
 - anaerobic filter, 173
 - biomass in, 697
 - effluent BOD removal efficiencies, 806
 - UASB, 172
 - See also* aerobic systems; anaerobic treatment systems
- anaerobic systems classifications
 - attached growth
 - expanded bed, 716
 - fixed bed, 716
 - rotating bed, 716
 - dispersed growth, 716

- anaerobic technology
 - combined with aerobic treatment, 809
 - domestic sewage treatment, 805
 - limitations
 - regarding microbiological indicators, 808
 - regarding nitrogen and phosphorus, 807
 - regarding organic matter, 806
- anaerobic treatment, 111, 659
- anaerobic treatment systems
 - additional BOD removal, 618
 - combined treatment systems, 726
 - conventional systems, 710
 - high-rate systems, 710, 716
 - nutrient removal, 619
 - pathogenic organisms removal, 619
- anaerobic zone, 503. *See also* aerobic zone;
facultative zone
- anaerobically digested sludge, 259
- comparison with raw sludge, 1217
- anionic flocculants, 1249
- annual costs of wastewater treatment process, 284
- anoxic zones, 979–980
- applied flux, 441. *See also* solids flux theory
- assimilation capacity of rivers, 80
- ATAD. *See* autothermal thermophilic aerobic digestion
- atmospheric pressure influence on oxygen transfer, 467
- atmospheric reaeration. *See* reaeration
- attached bacterial growth, 717. *See also* dispersed bacterial growth
- attached biomass, 317
 - growth, 311
 - reactors, 1114
 - See also* dispersed biomass growth
- automated process control, 1063
- automatic control aspects of wastewater treatment plants, 1063
- autothermal thermophilic aerobic digestion
 - defined, 1302
 - operational regime, 1302
 - system, 1322
 - systems design considerations, 1302, 1304
 - See also* thermophilic aerobic digestion
- autotrophic active biomass, 963
- autotrophic organisms, 89
 - carbon source for, 300
 - See also* chemoautotrophs
- bacteria
 - acetogenic, 666
 - acidogenic, 541, 666, 668
 - anaerobic, 540
 - caused diseases, 52
 - chemoautotrophic, 308
 - coliform. *See* coliform group
 - facultative chemoheterotrophic, 308
 - filamentous, 1055
 - floc-forming, 1055
 - heterotrophic, 81, 88
 - hydrolytic fermentative, 665
 - pathogenic, 1208
 - See also* bacterial growth
- bacteria and viruses removal
 - pH, 579
 - solar radiation, 579
- bacteria categories
 - Bacilli*, 308
 - Cocci*, 308
 - Spirilla*, 308
 - Vibrios*, 308
- bacteria classification (temperature-based)
 - mesophilic, 309
 - psychrophilic, 309
 - thermophilic, 309
- bacterial decay
 - aerobic treatment, 388
 - anaerobic treatment, 389
 - decay kinetics
 - bacterial decay coefficient, 127
 - Chick's law, 126
 - coliform concentration calculation, 127
 - intervening factors, 126
 - in water bodies, 126
 - net bacterial growth, 389
- bacterial die-off, 79
- bacterial growth
 - attached, 717
 - dispersed, 716, 720
 - endogenous respiration stage, 380
 - in flocs, 698
 - synthesis stage, 380
- bacterial growth curve
 - decline or decay phase, 382
 - exponential-growth phase, 382
 - lag phase, 381
 - stationary phase, 382
- bacterial growth kinetics
 - aerobic treatment, 385
 - anaerobic treatment, 385
 - bacterial concentration, 399
 - bacterial decay, 388

- bacterial growth kinetics (*cont.*)
 - cell wash-out time, 399
 - gross solids production, 389
 - Monod formulation, 383, 384
 - net solids production, 390
 - specific gross bacterial growth, 383
 - substrate assimilation and, 389
- bacterial metabolism, 183
 - heterotrophic, 381
- bacteriophages, 56
- baffled anaerobic reactor, 721
- baffled ponds
 - for coliform removal, 592
 - for helminth eggs removal, 607
- Bardenpho process
 - anoxic zone, 1001
 - final reaeration zone, 1001
 - five-stage (Phoredox), 1014, 1016
 - four-stage, 997, 1001
 - nitrogen removal efficiency, 1001
 - post-denitrification aspects, 1001
 - pre-denitrification aspects, 1001
 - system design criteria, 1003
- batch reactors, 331
- belt cleaning, 1284
- belt presses, 269
 - design, 1280
 - for sludge dewatering, 261
 - for sludge thickening, 257
 - operational aspects, 1284
 - performance, 1280
 - process description, 1280
 - See also* filter presses
- beneficial land application. *See* land application, beneficial
- benthic (sediment) demand, 87, 88
- biochemical oxidation of carbonaceous matter
 - anabolism, 377
 - catabolism, 378
 - ultimate oxygen demand, 379
- biochemical oxygen demand. *See* BOD
- biodegradability
 - carbonaceous matter, 368
 - classification of organic matter, 37
 - nitrogenous matter, 369
 - of industrial wastewater, 61
 - of wastewater, 42
- biodegradable biological solids, 870. *See also* biodegradable solids
- biodegradable COD, 672
- biodegradable nitrogenous matter
 - ammonia, 370
 - rapidly biodegradable, 369, 962
 - slowly biodegradable, 369, 962
- biodegradable organic matter, 369
- biodegradable solids, 871
 - suspended, 414
 - volatile, 869
- biodegradable suspended solids
 - gross production in reactor, 413
 - net production in reactor, 414
- biodegradable volatile solids removal, 871
- biodiscs, 1136, 1140
- biofilm
 - control at rotating biological contactors
 - design criteria, 1138
 - formation process, 315
 - in attached biomass growth, 314
 - thickness characteristics, 316
 - See also* floc
- biofilm reactors, 111
 - aerobic, 174, 179, 211, 1113
- biofilter
 - phases
 - gas phase, 215
 - liquid phase, 215
 - solid phase, 214
 - submerged aerated, 213, 1142
- biogas components
 - carbon dioxide gas, 1225
 - hydrogen sulphide, 1225
 - methane, 1225
- biogas production, 795
 - in anaerobic digestion, 1224
- biological cells
 - cell membrane, 299
 - cell wall, 299
 - cytoplasm, 299
 - nucleic acids
 - DNA, 300
 - RNA, 299
 - organelles, 299
 - See also* microbial cells
- biological COD removal, 674
- biological denitrification, 978
- biological excess sludge, 206
- biological loading rate for UASB reactors, 748
- biological nitrogen removal, 209, 998, 1014. *See also* biological phosphorus removal; combined nitrogen and phosphorus removal; nitrogen removal

- biological nitrogen removal systems
 - Bardenpho process, 997, 1001
 - design criteria for, 1003
 - intermittent operation reactor, 997, 1003
 - oxidation ditch, 997, 1001
 - performance comparison between, 1003
 - post-denitrification systems, 997, 998
 - pre-denitrification systems, 997, 1000
 - sequencing batch reactor, 1026
- biological nitrogen removal systems design criteria
 - aeration systems, 1005
 - internal recirculation, 1006
 - primary sedimentation, 1005
 - reactor, 1006
 - secondary sedimentation tanks, 1006
 - stirrers, 1005
- biological nutrient removal
 - activated sludge system design and, 1044
 - continuous flow systems for, 997
 - denitrification principles, 960, 978
 - eutrophication problems, 959
 - nitrification principles, 960, 965
 - nitrogen removal, 209, 998, 1014
 - phosphorus removal, 960, 986
- biological phosphorus removal, 1014
 - Acinetobacter* for, 986
 - between anaerobic and aerobic conditions, 987
 - by excess sludge, 989
 - PAOs, 986, 987
 - sequencing batch reactor for, 1027
 - under aerobic conditions, 986, 988
 - under anaerobic conditions, 986, 987
 - See also* biological nitrogen removal; combined nitrogen and phosphorus removal; phosphorus removal
- biological phosphorus removal influencing factors
 - design parameters, 989
 - detention time, 991
 - excess sludge treatment methods, 991
 - sludge age, 990
 - environmental factors
 - dissolved oxygen, 989
 - nitrate in anaerobic zone, 990
 - pH, 990
 - temperature, 990
 - influent sewage characteristics, 989, 991
 - suspended solids in effluent, 989, 992
- biological phosphorus removal modelling
 - effluent phosphorus concentration, 996
 - phosphorus fraction in suspended solids, 993
 - phosphorus removal with excess sludge, 995
- biological reactors
 - carbon removal in, 907
 - in-vessel, 271
 - See also* aerobic reactors; anaerobic reactors
- biological reactors loading rates
 - food-to-microorganism ratio, 404
 - sludge age, 407
 - sludge load, 404
 - substrate utilisation rate, 407
 - surface loading rate, 410
 - surface organic load, 410
 - total suspended solids, 405
 - volatile suspended solids, 405
 - volumetric hydraulic load, 410
 - volumetric organic load, 409
- biological selectors
 - configuration
 - complete-mix reactors, 1057, 1058
 - plug-flow reactors, 1057, 1058
 - filamentous bacteria, 1055
 - floc-forming bacteria, 1055
- biological selectors classification (based on oxygen availability)
 - aerobic, 1059, 1060
 - anaerobic, 1059, 1060
 - anoxic, 1059, 1060
- biological sludge, 245
 - aerobic, 247
 - anaerobic, 247
 - See also* excess sludge
- biological solids, 1183
 - biological solids distribution in reactor
 - gross production of
 - biodegradable suspended solids, 413
 - fixed suspended solids, 413
 - non-biodegradable volatile suspended solids, 414
 - total suspended solids, 413
 - volatile suspended solids, 413, 414
 - inorganic fraction, 411
 - net production of
 - biodegradable suspended solids, 414
 - total suspended solids, 415
 - volatile suspended solids, 414
 - organic (volatile) fraction
 - biodegradable, 411
 - non-biodegradable (inert), 411

- biological solids production, 877
 - gross solids production, 389
 - substrate removal rate, 391
- biological stabilisation, 1214
 - aerobic, 259, 1215
 - anaerobic, 259, 1215
- biological treatment for pathogen removal, 1292
- biological treatment of industrial wastewater
 - biodegradability, 61
 - BOD, 61
 - nutrient availability, 61
 - toxicity, 61
 - treatability, 61
- biological unit processes (wastewater treatment), 168
- biological wastewater treatment, 297
 - aerobic, 709, 1320
 - anaerobic, 1320
 - ecology of, 306
 - metals removal potential, 1198
 - oxidation, 367
 - protozoa role, 310
 - reduction, 367
 - total nitrogen and, 33
- biological wastewater treatment processes
 - reaction kinetics, 319, 320
 - reactor hydraulics, 330
- biological wastewater treatment systems
 - activated sludge, 173, 202
 - aerobic biofilm reactors, 174, 211
 - anaerobic systems, 172, 198
 - land disposal, 172, 191
 - metals removal efficiencies, 1201
 - stabilisation ponds, 171, 184
- biomass (carbon source-based groups)
 - autotrophic, 370
 - heterotrophic, 370
- biomass (viability-based groups)
 - active, 370–371
 - inert residue, 370
- biomass characterisation
 - active biomass
 - autotrophic, 371, 963
 - heterotrophic, 370, 962
 - inert residue, 963
- biomass concentration, 840
 - effluent BOD, 403
 - effluent substrate, 401, 402
 - influent BOD, 403
 - influent substrate, 401
- biomass concentration in reactor
 - with solids recirculation, 400
 - without solids recirculation, 401
- biomass growth
 - attached, 311, 314
 - dispersed, 311, 312
- biomass in anaerobic systems
 - biomass retention, 697
 - microbial activity evaluation, 702
 - microbial mass evaluation, 700
- biomass modelling
 - cell wash-out time, 399
 - hydraulic detention time, 396
 - hypotheses, 397, 398
 - in complete-mix reactor, 392
 - mass balance in reactor, 392
 - solids recirculation concept, 393
 - solids retention time, 396
 - systems with solids recirculation, 394, 400
 - systems without solids recirculation, 394, 400
- See also* substrate modelling
- biomass production
 - aerobic treatment, 390
 - anaerobic treatment, 390
 - BOD concentration, 389
 - COD concentration, 389
 - gross solids production, 389
 - net solids production, 390
 - suspended solids, 389
 - volatile suspended solids, 389
- biomass representation
 - suspended solids, 371
 - volatile suspended solids, 371
- biomass retention
 - by attachment, 698
 - by flocculation, 698
 - by granulation, 699
 - in anaerobic systems, 697
 - interstitial retention, 700
- biosolids, 248, 1168
 - agronomic quality, 1345
 - application and incorporation
 - dry biosolid, 1355
 - heat-dried granular biosolid, 1355
 - liquid biosolid, 1354
 - as soil conditioners, 1331
 - disposal alternatives, 1364
 - management trends, 1317
 - nitrogen in, 1330
 - nutrient recommendation, 1345
 - organic matter, 1331
 - phosphorus in, 1331

- recycling, 1321
- storage aspects, 1352
- transportation aspects, 1353
- use. *See* biosolids use
- biosolids land application
 - agriculture, 1329, 1345
 - carbonate calcium equivalency, 1345, 1346
 - nutrient recommendation, 1345
 - associated risks, 1343
 - crops suitability aspects, 1343
 - erosion control, 1334
 - for environmental pollution control, 1334
 - limitations. *See* biosolids quality
 - risks, 1335, 1337
 - direct contact with humans and animals, 1338
 - groundwater contamination, 1338
 - surface water contamination, 1338
 - sanitation sector usage, 1335
 - site selection aspects, 1343
 - soil aptitude, 1338
 - See also* biosolids use
- biosolids land application operational aspects
 - distribution operation
 - control programme, 1367
 - technical staff selection and training, 1367
 - distribution planning
 - biosolid disposal alternatives, 1364
 - environmental licensing, 1366
 - monitoring, 1366
 - public acceptance, 1364
 - technical assistance, 1365
 - treatment plant structure, 1364
 - preliminary planning
 - application area, 1361
 - biosolids production, 1358
 - biosolids quality, 1361
 - preliminary survey, 1358
- biosolids management
 - alkaline stabilisation and, 1336
 - composting and, 1336
 - thermal drying and, 1336
- biosolids quality, 1316
 - and pathogen removal processes
 - alkaline stabilisation, 1336
 - composting, 1336
 - thermal drying, 1336
 - biological stability and vector attraction, 1337
 - metals content, 1335
 - organic pollutants, 1337
- biosolids use
 - farming, 1362
 - future use, 1362
 - landscape gardening, 1362
 - reclamation areas, 1362
 - reforestation, 1362
 - substrate, 1362
- BNR. *See* biological nutrient removal
- BOD
 - advantages, 39
 - and deoxygenation kinetics, 94
 - effluent BOD, 403, 523
 - industrial wastewater, 61
 - influent BOD, 403, 523
 - limitations, 40
 - particulate effluent, 521
 - removal. *See* BOD removal
 - soluble effluent, 521, 523
 - soluble or filtered, 183
 - standard, 39
 - suspended or particulate, 183
 - ultimate. *See* ultimate BOD
 - See also* COD
- BOD concentration, 78
 - anaerobic ponds, 540
 - concentration problems
 - particulate BOD, 1098
 - soluble BOD, 1099
 - effluent BOD, 567, 863
- BOD load
 - domestic, 76
 - industrial, 76, 67
 - infiltration water, 76
 - total, 76
- BOD removal, 518
 - activated sludge system, 845
 - complete-mix aerated lagoons, 567
 - facultative aerated lagoons, 555
 - post-treatment of anaerobic effluent, 617, 618
 - sequencing batch reactor for, 1027
- BOD removal coefficients
 - anaerobic ponds, 545, 546
 - complete-mix model
 - facultative pond design, 523
 - removal coefficient, 523
 - dispersed-flow model
 - dispersion number, 526
 - removal coefficient, 526
 - facultative ponds
 - primary, 523
 - secondary, 523
 - plug-flow model, 530

- BOD removal efficiency
 activated sludge system, 868
 anaerobic ponds, 541
 complete-mix model, 530
 conventional activated sludge system, 946
 dispersed-flow model, 530
 plug-flow model, 530
 trickling filter, 1128
 UASB reactors, 750, 751
- BOD_u. *See* ultimate BOD
- bottom of stabilisation ponds
 groundwater contamination problem, 626
 soil permeability aspects, 626
 waterproofing aspects, 626
- break-point chlorination, 170
- bulking sludge, 1078. *See also* rising sludge
- bulking sludge problems
 causes
 low DO concentration, 1079
 low floc load, 1088
 nutrient deficiency, 1088
 pH concentrations, 1087
 rapidly biodegradable carbohydrates presence, 1089
 septicity, 1089
 detection, 1078
- cake
 defined, 1244
 discharge, 1274
 moisture content, 1284
- capillary water removal, 1243, 1244
- carbon dioxide gas as biogas component, 1225
- carbon fixation, 1333
- carbon removal in biological reactor, 907
- carbon source for
 autotrophic organisms, 300
 heterotrophic organisms, 300
- carbon/nitrogen ratio for composting, 1295
- carbonaceous matter
 biodegradable, 368, 369
 inert (nonbiodegradable), 368
See also nitrogenous matter
- carbonaceous matter conversion
 aerobic conversion, 373
 anaerobic conversion, 374
 biochemical oxidation, 377
See also nitrogenous matter conversion
- carbonaceous organic matter
 in sewage, 37
 oxidation, 886
 quantification methods
 BOD, 38
 COD, 38, 42
 TOC, 38, 43
 ultimate BOD, 38, 40
See also nitrogenous organic matter
- carbonaceous oxygen demand
 for endogenous respiration, 888
 for substrate oxidation, 888
 method for excess sludge removal, 887
See also COD
- carbonate calcium equivalency, 1345, 1346
- Carrousel-type oxidation ditches, 909, 911, 913, 1001
- CASS. *See* cyclic activated sludge system
- catabolism, 378
 fermentative, 302
 oxidative, 302
See also anabolism
- catchment area and eutrophication
 agricultural occupation, 135
 occupation by woods and forests, 134
 urban occupation, 135
- catchment area and water quality
 human beings interference, 3
 natural conditions, 3
See also land use and water quality
- cation exchange capacity, 1332
- cationic polyacrylamides, 1249
- cationic polyelectrolyte, 1270
- cationic polymers, 1250
- CCE. *See* carbonate calcium equivalency
- CEC. *See* cation exchange capacity
- cell wash-out time, 399
- cells in series and in parallel, 351–353
- cells, microbial, 300. *See also* biological cells
- cellular water removal, 1243, 1244
- central-feeding circular tank, 915
- centrifugation, 266
 as sedimentation process, 1267
 performance, 1270
- centrifuges
 advantages, 1270
 design, 1271
 efficiency, 1270
 for sludge dewatering, 261, 1265, 1269
 horizontal shaft, 266
 vertical shaft, 266
 for sludge thickening, 257
 operational aspects, 1273

- centrifuges types
 - countercurrent, 1269
 - decanter-type, 1269
 - horizontal-shaft, 1268
 - vertical-shaft, 1268
- CEPT. *See* chemically enhanced primary treatment
- CFSTR. *See* continuous-flow stirred tank reactors
- chemical oxygen demand. *See* COD
- chemical precipitation
 - after biological treatment, 1319
 - pre-precipitation aspects, 1319
 - See also* precipitation
- chemical sludge, 244, 245, 248
- chemical stabilisation, 259, 1214
- chemical treatment for pathogen removal, 1291
- chemical unit processes (wastewater treatment), 168. *See also* biological unit processes; physical unit operations
- chemically enhanced primary treatment, 181
- chemoautotrophic bacteria, 308
- chemoautotrophs, 88, 301, 963
- chemoheterotrophs, 301
- chemotrophic organisms energy source, 300
- chlorides-based wastewater characteristics, 34
- chlorination, 842
 - as pathogen removal mechanism, 218
 - break-point, 170
- chlorine demand for disinfection, 842
- Chlorophyta*. *See* green algae
- Ciliates*, 310
- circular secondary sedimentation tank, 917, 955
- circular sedimentation tank, 939
- clarification criteria for secondary sedimentation tanks, 922–929
- Class-A sludges, 1289, 1291
- Class-B sludges, 1289
- Class-I soils, 1338
- Class-II soils, 1338
- Class-III soils, 1339
- Class-IV soils, 1339
- Class-V soils, 1339
- clay for preparing pond's bottom, 627
- clean water test
 - steady state method, 480
 - unsteady state method, 480
- cleanwater zone, 84
- Clostridium perfringens*, 56
- coagulants, metallic. *See* metallic coagulants
- coagulation, 1248
- coarse solids removal, 180
 - objectives of, 174
 - problem of anaerobic filter, 792
 - problem of UASB reactor, 794
- coarse solids by-products, 246
- COD, 33
 - advantages, 42
 - limitations, 42
 - See also* BOD; ultimate BOD
- COD balance
 - acidifiable, 672
 - biodegradable, 672
 - hydrolysable, 674
 - recalcitrant, 673
 - soluble and particulate, 673
- COD removal
 - adsorption, 676
 - biological COD, 674
 - efficiencies in UASB reactors, 750, 751
 - in wet air oxidation reactor, 1378
 - non-biological COD, 675
 - precipitation, 675
- COD solubility
 - filtered, 673
 - particulate, 673
 - soluble, 673
- COD/TKN ratio, 992
- coliform, 126
 - quality requirements, 590
 - removal in activated sludge system, 842
- coliform concentration
 - arithmetic mean, 591
 - geometric mean, 591
- coliform die-off coefficient
 - complete-mix regime, 588
 - dispersed-flow regime, 584
 - facultative ponds, 587
 - maturation ponds, 587
 - plug-flow regime, 589
 - primary ponds, 587
 - secondary ponds, 587
 - tertiary ponds, 587
- coliform group
 - E. coli*, 53–55
 - faecal, 53, 54, 55
 - thermotolerant, 53, 54, 55
 - total, 53, 54, 55

- coliform removal efficiency, 128
 - of complete-mix ponds, 580, 581
 - of dispersed-flow ponds, 582, 583
 - of plug-flow ponds, 580, 581
- coliform removal pond design criteria
 - baffled ponds, 592
 - depth, 592
 - detention time, 592
 - length/breadth ratio, 592
 - ponds in series, 592
- colour characteristics of ponds, 534
- combined (anaerobic/aerobic) treatment
 - advantages, 809
- combined nitrogen and phosphorus removal
 - A²O process, 1014–1016
 - design criterion, 1018
 - five-stage Bardenpho process, 1014–1016
 - in anaerobic zone, 1014
 - UCT process, 1015–1016
 - recirculation aspects, 1014
 - removal processes selection, 1017
 - sequencing batch reactor for, 1028
 - See also* nitrogen removal; phosphorus removal
- combined sewerage, 11. *See also* separate sewerage
- complete-mix aerated lagoons, 495–496
 - BOD removal, 567
 - dissolved organic matter, 567
 - effluent BOD concentration, 567
 - followed by sedimentation ponds, 564
 - influent BOD, 565
 - land requirements, 564
 - oxygen requirements, 569
 - oxygenation efficiency, 570
 - particulate effluent BOD, 569
 - power requirements, 570
 - process description, 565
 - recirculation absence, 565
 - sludge accumulation, 571
 - soluble effluent BOD, 567
 - suspended organic matter, 567
 - volatile suspended solids concentration, 567
 - See also* stabilisation ponds
- complete-mix aerated lagoons design criteria
 - depth, 566
 - detention time, 566
 - See also* sedimentation pond design criteria
- complete-mix behaviour of activated sludge reactors, 909, 910
- complete-mix cells in series, 344
- complete-mix effluent coliform concentration, 580
- complete-mix model based BOD removal
 - BOD removal coefficient, 523
 - facultative pond design, 523
- complete-mix ponds
 - coliform die-off coefficient, 588
 - coliform removal efficiency, 580, 581
- complete-mix reactor, 331, 332
 - biodegradable substances
 - with first-order reaction, 340, 343
 - with zero-order reaction, 338, 342
 - concentration profiles, 339
 - conservative substances, 338, 342
 - dispersion, 347
 - effluent BOD concentration, 518, 519
 - first order reaction coefficients, 357, 358
 - in series, 341
 - influent concentration variations, 366
 - mass accumulation, 337
 - transient analysis, 365
 - under steady-state conditions, 339
 - See also* plug-flow reactors
- complete-mix reactor modelling
 - biological reactors loading rates, 404
 - biological solids distribution, 411
 - cell wash-out time, 399
 - effluent substrate, 402
 - hydraulic detention time, 396
 - mass balance, 392
 - reactor with solids recirculation, 394
 - reactor without solids recirculation, 394
 - sludge age, 407
 - sludge load, 404
 - solids retention time, 396
 - substrate and biomass modelling, 392
 - substrate utilisation rate, 407
 - surface organic load, 410
 - suspended solids concentration, 400
 - volumetric hydraulic load, 410
 - volumetric organic load, 409
- completely-stirred tank reactor, 92, 565
- composting
 - advantages and disadvantages, 1241
 - aerated static pile composting, 1239
 - biosolids management and, 1336
 - in-vessel composting, 1239
 - requirements, 1240
 - windrow composting, 1239

- composting for pathogens reduction
 - aeration aspects, 1296
 - carbon/nitrogen ratio, 1295
 - characteristics, 1293
 - initial mesophilic phase, 1294
 - moisture monitoring, 1296
 - pH parameter, 1297
 - sludge physical structure, 1295
 - temperature aspects, 1296
 - thermophilic phase, 1294
- composting methods
 - aerated static pile, 271, 1298
 - in-vessel system, 271, 1298
 - windrow, 271, 1297
- composting systems
 - operational troubleshooting aspects, 1302
 - operational troubleshooting, 1303
- compression settling, 424
- concrete coatings, 767
- conditioning. *See* sludge conditioning
- conservative substances
 - complete-mix reactors, 338, 342
 - plug-flow reactors, 333
- constructed wetlands, 172, 195
 - subsurface flow, 196
 - surface flow, 196
 - See also* natural wetlands
- contaminants in sludge
 - metals, 1197, 1198
 - pathogenic organisms, 1197
 - trace organic contaminants, 1197
- continuous-flow activated sludge reactors
 - design parameters, 908
 - design, 912
 - intermediate plants, 907
 - larger plants, 907
 - smaller plants, 907
 - organic matter removal
 - biodegradable solids, 869, 871
 - BOD, 868, 908
 - carbon, 907
 - excess sludge, 881, 887
 - nitrogen, 898
 - organic carbon, 908
 - substrate, 862
 - volatile biodegradable solids, 869
 - volatile solids, 871
 - physical configurations
 - Carrousel-type oxidation ditches, 909, 911, 913
 - complete mix, 909, 910
 - Pasveer-type oxidation ditches, 909, 911, 913
 - plug-flow, 910, 912
 - step aeration, 910
 - step feeding, 910
- continuous-flow systems
 - activated sludge system, 839, 844–845, 1033
 - conventional activated sludge, 844
 - extended aeration, 845
 - for biological nutrient removal
 - biological nitrogen removal, 997
 - combined removal of nitrogen and phosphorus, 1014
 - for organic matter removal, 855, 906
 - stirred tank reactors, 519
- control algorithms
 - control by expert systems, 1065
 - feedback control, 1064, 1065
 - feedforward control, 1064
 - optimal control, 1065
- conventional activated sludge, 204–206, 843–844, 857
- conventional activated sludge system
 - excess sludge removal, 883
 - nitrification, 892
 - with pre-denitrification, 1007
 - See also* biological excess sludge
- conventional activated sludge system
 - design
 - area requirement, 954
 - BOD removal efficiency, 946
 - circular secondary sedimentation tank, 955
 - design parameters
 - aeration system, 944
 - reactor, 944
 - removal efficiencies, 944
 - secondary sedimentation tank, 944
 - diffused-air aeration alternative, 953
 - effluent loads and concentrations
 - BOD, 945
 - SS, 945
 - TKN, 945
 - excess sludge removal, 949
 - mechanical aeration alternative, 952
 - oxygen requirements, 950
 - primary sedimentation tank, 956
 - reactor volume, 949
 - rectangular secondary sedimentation tank, 956
 - solids distribution, 946
 - soluble BOD, 945

- conventional systems
 - anaerobic pond, 710, 715
 - septic tanks, 710, 714
 - sludge digesters, 710, 711
- conversion process in DO balance
 - mechanism, 86
- countercurrent horizontal centrifuge, 1269
- coverage index. *See under* population forecast and sewage system
- crops suitability. *See under* biosolids land application
- CSTR. *See* completely-stirred tank reactor
- cultivation with biosolids, 1344
- Cyanobacteria*, 505
- cycle of water. *See* water cycle
- cyclic activated sludge system, 1028
- cytoplasm. *See under* biological cells

- dead volumes, 346
- decanter-type centrifuge, 1269
- dechlorination, 842
- decreasing growth rate method, 16, 19. *See also* population forecast methods
- deforestation aspects of stabilisation ponds
 - construction, 623
- degradation zone, 82
- denitrification, 44, 47, 376, 610, 964
 - and activated sludge, 209
 - and biological nutrient removal, 960
 - bacteria for, 308
 - cause behind rising sludge problem, 1075
- environmental factors influence
 - dissolved oxygen, 983, 984
 - pH, 985
 - temperature, 984
 - toxic or inhibiting substances, 985
- heterotrophic microorganisms for, 979
- intentional-induction in treatment system
 - alkalinity economy, 980
 - nutrient control, 981
 - oxygen economy, 980
 - secondary sedimentation tank operation, 981
- kinetics, 982
- modelling, 1004
- nitrogen removal mechanism, 170
- post. *See* post-denitrification
- pre. *See* pre-denitrification
- under aerobic conditions, 979
- under anaerobic conditions, 979
 - under anoxic conditions, 304, 979
 - See also* ammonification; nitrification
- deoxygenation coefficient, 95, 97, 113
- deoxygenation kinetics
 - deoxygenation coefficient, 97
 - mathematical formulation, 93
 - temperature influence, 99
 - See also* reaeration kinetics
- deoxyribonucleic acids, 300
- depth as design criteria for
 - anaerobic ponds, 542, 545
 - coliform removal pond, 592, 596
 - complete-mix aerated lagoons, 566
 - facultative aerated lagoons, 553
 - facultative ponds, 512, 514
 - sedimentation pond, 570, 571
- design horizon and staging periods, 281
- detention time
 - anaerobic ponds design criteria, 542, 544
 - coliform removal pond design criteria, 592
 - complete-mix aerated lagoons design criteria, 566
 - facultative aerated lagoons design criteria, 553
 - facultative ponds designing, 512, 516
 - for primary sedimentation tank, 940
 - influence on phosphorus removal
 - in aerobic zone, 991
 - in anaerobic zone, 991
 - sedimentation pond design criteria, 570, 571
- dewaterability
 - aspects of aerobic digesters, 1235, 1236
 - sludge. *See* sludge dewaterability
- dewatered sludges, 262, 1306
- dewatering, 1322
 - as water removal process, 1243
 - efficiency influencing factors, 1256
 - processes performance, 1256
 - sludge characteristics, 1172
 - sludge. *See* sludge dewatering
- diffuse pollution, 10
- diffused-air aeration, 457
 - regulation methods, 1065
 - See also* mechanical aeration
- diffused-air aeration systems, 471
 - aspirating aerator, 477
 - characteristics, 479
 - coarse bubble, 478
 - fine bubble, 478
 - jet aerator, 477

- medium bubble, 478
- non-porous diffuser, 477
- oxygen transfer efficiency, 478
- porous diffuser, 477
- U-tube aerator, 477
- See also* mechanical aeration systems
- diffusion
 - coefficient, 462, 464
 - molecular, 89, 461
 - turbulent, 89, 461, 463
- digested sludge, 259
 - dewatering, 260
 - heating power, 1226
 - odour and aspect, 1235
 - See also* raw sludge
- digester feeding, 1231
- digestion
 - aerobic. *See* aerobic digestion
 - anaerobic. *See* anaerobic digestion
 - sludge characteristics, 1172
 - thermophilic aerobic, 272
- dikes. *See* pond dikes
- discharge standards. *See* wastewater
 - discharge quality standards
- discrete settling
 - for sedimentation tank with horizontal flow, 427, 429
 - kinematic viscosity, 426
 - removal efficiency, 431
 - settling velocity, 425
 - Stokes law, 425
 - tests, 429
 - See also* flocculent settling; zone settling
- diseases
 - bacteria caused, 52
 - faecal–oral, 49
 - helminths caused, 52
 - protozoan caused, 52
 - viruses caused, 52
 - water hygiene, 52
 - water-borne, 52
- disinfection
 - as pathogen removal mechanism, 169
 - chlorine demand for, 842
 - sludge. *See* sludge disinfection
- dispersed bacterial growth, 720. *See also*
 - attached bacterial growth
- dispersed biomass, 317. *See also* attached biomass
- dispersed biomass growth, 311, 312
- dispersed-flow and effluent coliform
 - concentration, 580, 582
- dispersed-flow model
 - based BOD removal coefficient, 525–526
 - dispersion number, 526
- dispersed-flow pond
 - coliform die-off coefficient, 584
 - coliform removal efficiency, 582, 583
- dispersed-flow reactor
 - first order reaction coefficients, 357, 358
 - hydraulics, 331
 - dispersion number, 346
 - removal efficiency (first order reaction), 349, 350
- dispersed sludge problems
 - causes, 1092
 - detection, 1092
 - See also* bulking sludge; rising sludge
- dispersion number
 - Agunwamba model, 529
 - Polprasert model, 529
 - von Sperling and Yanez models, 529
- dispersion problem, 346
- dispersion process in DO balance
 - mechanism, 86
- dissimilation. *See* catabolism
- dissolved air flotation, 257
 - thickening, 1246
 - See also* gravity thickening
- dissolved concentration, 93
- dissolved organic matter
 - complete-mix aerated lagoons, 567
 - facultative aerated lagoons, 554
- dissolved organic solids, 372
- dissolved oxygen. *See* DO
- dissolved solids, 35. *See also* suspended solids
- DNA, 300
- DO (dissolved oxygen), 39
 - consumption, 79, 80
 - levels as rotating biological contactors
 - design criteria, 1139
 - profile, 93
 - See also* BOD; COD; ultimate BOD
- DO balance
 - advection process, 86
 - conversion process, 86
 - deoxygenation kinetics, 93
 - dispersion process, 86
 - interacting factors, 84, 86
 - oxygen consumption, 87
 - oxygen production, 88
 - reaeration kinetics, 99
 - sag curve, 104
 - water quality models, 90
 - See also* self-purification

- DO concentration
 - deoxygenation kinetics, 93
 - reaeration kinetics, 99
 - sag curve, 105
 - saturation concentration, 114
 - temperature influence on, 467
- DO control
 - diffused air regulation, 1065
 - mechanical aeration regulation, 1065
- DO influence on
 - biological phosphorus removal, 989
 - denitrification, 984
 - nitrification, 967
- DO model input data
 - deoxygenation coefficient, 113
 - in river, 110
 - in wastewater, 111
 - minimum allowable DO concentration, 115
 - reaeration coefficient, 113
 - river BOD, 112
 - river flow, 109
 - saturation concentration, 114
 - travel time, 113
 - velocity of water body, 113
 - wastewater BOD, 112
 - wastewater flow, 110
- DO sag curve, 93
 - BOD removal efficiency, 108
 - characteristic points in, 106
 - critical deficit and concentration, 108
 - critical time, 107
 - DO profile as a function of time, 107
 - model equations, 105
- domestic BOD, 76
- domestic flow, 74
- domestic sewage
 - anaerobic digestion, 682
 - BOD concentration, 59, 60
 - characteristics, 32
 - COD/BOD ratio, 42
 - discharge standards, 164
 - effluent concentrations, 223
 - nitrogen forms in, 46
 - per capita BOD load, 59, 60
 - removal efficiencies of, 223
 - sewage flow, 13, 23, 26
 - TKN in, 45
 - total phosphorus in, 47
- domestic sewage, main organisms in, 60
 - algae, 34
 - bacteria, 34
 - fungi, 34
 - helminths, 34
 - protozoa, 34
 - virus, 34
- domestic sewage treatment
 - anaerobic ponds, 540
 - anaerobic technology, 805
- domestic wastewater flow, 12
 - average water consumption, 21
 - flow variations, 26
 - population forecast, 13
 - sewage flow, 23, 26
 - See also* wastewater flowrates
- Dortmund-type tank, 915, 918, 941
- drainage system for sludge drying beds, 1258
- dredging, 649
- dry biosolid application, 1355. *See also* liquid biosolid application
- dry polymers
 - feeding system, 1251
 - in dewatering processes, 1252
 - See also* liquid polymers
- dry solids, 1179
 - concentration, 249
 - levels in
 - dewatered sludge, 262
 - thickened sludge, 258
- drying beds. *See* sludge drying beds
- drying lagoons. *See* sludge drying lagoons
- dynamic state of mass balance, 329
- E. coli* (EC). *See* *Escherichia coli*
- ecological aspects of stream
 - self-purification
 - in natural conditions, 81
 - under disturbance, 81
- ecology of wastewater treatment
 - bacteria, 307
 - biofilm in, 314
 - biological floc, 312
 - biomass growth, 311
 - protozoa, 309
 - See also* microbiology of wastewater treatment
- economical study of alternatives
 - annual costs, 284
 - implementation costs, 284
- effluent, 45
 - BOD, 523
 - coliform quality requirements, 590
 - collection from UASB reactors, 760
 - discharges above assimilative capacity of water bodies, 80

- distribution in anaerobic filters, 736
- from anaerobic reactor, 617
- industrial, 61
- pond effluents, 534
- recirculation in anaerobic filters, 732
- weirs, 937
- effluent BOD concentration
 - activated sludge system, 863
 - complete-mix aerated lagoons, 567
 - concentration problems
 - particulate BOD, 1098
 - soluble BOD, 1099
 - facultative aerated lagoons, 554
 - from anaerobic ponds, 545
 - in anaerobic ponds, 541
 - in complete-mix reactors, 518, 519
 - in plug-flow reactors, 518, 519
 - particulate effluent BOD, 521
 - removal efficiencies, 806
 - soluble effluent BOD, 521
 - total effluent BOD, 521
- effluent coliform concentration
 - hydraulic regime influence, 579
 - complete-mix, 580
 - dispersed flow, 580, 582
 - plug-flow, 580
 - idealised hydraulic regime
 - ideal plug-flow pond, 581
 - ideal-complete mix pond, 581
- effluent phosphorus concentration
 - particulate, 996
 - soluble, 996
- effluent post-treatment
 - activated sludge alternative, 826
 - activated sludge system for, 842, 848, 1042, 1045
 - anaerobic. *See* anaerobic effluent post-treatment
 - anaerobic filters alternative
 - configuration, 811
 - considerations for, 811
 - design criteria, 812
 - land disposal alternative
 - configuration, 817
 - design criteria, 817
 - overland flow considerations, 814
 - polishing pond alternative
 - configuration, 813
 - considerations for, 812
 - design criteria, 813
 - submerged aerated biofilter alternative, 824
 - trickling filter alternative, 822
 - UASB reactor, 811
- effluent substrate
 - and biomass concentration, 402, 403
 - particulate BOD, 373
 - particulate COD, 373
 - soluble BOD, 372
 - soluble COD, 372
 - See also* influent substrate
- EGSB reactors, 723–724. *See also* UASB reactors
- EIA. *See* environmental impact assessment
- electron acceptor, 303
- electron donors, 302
- employment forecast. *See under* population forecast methods
- emulsified grease and oil problems, 1078
- endoenzymes, 301, 309. *See also* exoenzymes
- endogenous respiration
 - bacterial growth, 380
 - biochemical oxidation, 378
 - oxygen demand for, 888
- energy generation in microbial cells
 - denitrification, 303, 304
 - electron acceptor, 303
 - electron donors, 302
 - methanogenesis, 303
 - oxidation reactions, 302, 303
 - sulphate reduction, 303
 - under aerobic conditions, 304
 - under anaerobic conditions, 304
 - under anoxic conditions, 304
- energy source for
 - chemotrophic organisms, 300
 - phototrophic organisms, 300
- Enterococcus*, 56
- environmental factors influence on
 - denitrification, 983–985
 - nitrification, 967–968
- environmental impact assessment, 281
 - biosolids land application in agriculture, 1333
 - landfill disposal, 1383
 - sludge disposal alternatives, 278
 - sludge processing alternatives, 1325
- environmental impact on stabilisation ponds
 - air temperature, 511
 - liquid temperature, 511
 - mixing mechanism, 508, 510
 - thermal stratification, 508, 509
 - water temperature, 511
 - wind, 509

- environmental legislation for sludge processing alternatives, 1321
- environmental monitoring aspects in landfarming, 1371
- environmental pollution control, 1334
- environmental requirements for anaerobic digestion, 681
- enzymatic reaction rates, 687
- enzymes
 - endoenzymes, 301
 - exoenzymes, 301
- erosion control, 1334
- Escherichia coli*, 53, 54
 - coliforms, 55
- Euglenophyta*. *See pigmented flagellated algae*
- eukaryotes, 298, 309. *See also* prokaryotes
- European Community Directive for wastewater discharge, 163
- European Community guidelines
 - nitrogen discharge, 960
 - phosphorus discharge, 959
- eutrophic level, 139. *See also* mesotrophic level; oligotrophic level
- eutrophication, 79
 - algal blooms, 136
 - nutrient control and, 210
 - of lakes and reservoirs, 133
 - trophic levels, 139
- eutrophication and land use
 - agricultural occupation, 135
 - occupation by woods and forests, 134
 - urban occupation, 135
- eutrophication control
 - corrective methods, 148–150
 - preventive methods, 147–148
 - stormwater drainage control, 147
 - wastewater control, 147
- eutrophication problems, 959
 - anaerobic conditions-based problem, 136, 137
 - gradual lake disappearance, 137
 - increase in water treatment costs, 137
 - industrial water supply problems, 137
 - occasional fish mortality, 137
 - recreational and aesthetic problems, 136
 - water toxicity, 137
- excess biological sludge stabilisation, 845
- excess sludge, 840, 848, 857
 - biological phosphorus removal and, 989, 991
 - flow, 877
 - flow controlling aspects, 1068
 - phosphorus removal with, 995
- excess sludge production
 - biological solids, 877
 - in activated sludge system, 877, 879
 - solids present in raw sewage, 879
 - solids without considering raw sewage solids, 881
 - VSS/SS ratio, 879
- excess sludge removal
 - carbonaceous oxygen demand based method, 887
 - considering influent solids
 - withdrawal from reactor, 882
 - withdrawal from return sludge line, 883
 - from conventional activated sludge system, 949
 - in activated sludge system, 881
 - without considering influent solids
 - sludge withdrawal from reactor, 881
 - withdrawal from return sludge line, 882
- See also* excess sludge production
- exclusive landfills, 1384
- exoenzymes, 301, 309, 665. *See also* endoenzymes
- expanded bed anaerobic reactor, 719
- expanded granular sludge bed reactor. *See* EGSB reactors
- exposure and contamination hazards
 - exposure by direct contact, 1287
 - exposure by indirect contact, 1288
- exposure of air-to-water mass. *See under* gravity mechanism
- exposure of water-to-surrounding air. *See under* gravity mechanism
- extended aeration, 857
 - activated sludge, 205
 - system, 843–846, 883
- facultative aerated lagoons, 171, 187, 496
 - aeration system, 558
 - anaerobic decay, 555
 - effluent BOD concentration, 554
 - influent BOD, 555
 - oxygen requirements, 557
 - oxygenation efficiency, 558
 - particulate effluent BOD, 556
 - particulate influent BOD, 557
 - power level, 556
 - power requirements, 558
 - process description, 552
 - sludge accumulation, 560
 - soluble effluent BOD, 554, 557
 - soluble influent BOD, 557

- SS concentrations, 556
 - See also* stabilisation ponds
- facultative aerated lagoons design criteria
 - depth, 553
 - detention time, 553
- facultative chemoheterotrophic bacteria, 308
- facultative organisms, 303
- facultative ponds, 171, 184
 - advantages, 502
 - algae influence, 505
 - BOD removal
 - complete-mix model-based, 523
 - dispersed-flow model-based, 525, 526
 - characteristics, 497
 - coliform die-off coefficient, 587
 - dispersion number, 526
 - effluent BOD concentration
 - in complete-mix reactors, 518
 - in dispersed flow reactors, 519
 - in plug-flow reactors, 518
 - effluent characteristics, 505
 - facultative aerated ponds, 497
 - facultative zone, 503, 505
 - following anaerobic ponds, 547
 - helminth eggs removal, 604
 - maturation ponds, 518
 - nitrogen removal efficiency, 611
 - operational problems, 640
 - organic load influence, 507
 - photosynthesis process, 503, 507
 - primary, 517, 523
 - process description, 503
 - respiration process, 503, 507
 - secondary, 517, 523, 547
 - sludge accumulation aspects, 533
 - start-up operation, 638
 - unaerated, 554
 - working principle, 504
 - See also* anaerobic pond/facultative pond; stabilisation ponds
- facultative ponds design
 - cells in parallel, 532
 - cells in series, 532
 - internal divisions, 533
 - organic overload, 533
 - plug flow, 533
- facultative ponds design criteria
 - depth, 512, 514
 - detention time, 512, 516
 - geometry, 512, 517
 - surface organic loading rate, 512, 513
- facultative zone, 503, 505. *See also* aerobic zone; anaerobic zone
- faecal coliforms, 53–55, 590
- faecal contamination
 - bacteria of coliform group, 53
 - indicators, 53
 - pathogenic organisms and, 49
- faecal contamination indicators, 49
 - bacteriophages, 56
 - Escherichia coli*, 53–55
 - faecal coliforms, 53, 54, 55
 - faecal *streptococci*, 56
 - helminth, 57
 - sulphite-reducing *clostridia*, 56
 - thermotolerant coliforms, 53, 54, 55
 - total coliforms, 53, 54, 55
- faecal–oral diseases, 49, 52
- fatty acids, volatile, 663
- FC. *See* faecal coliforms
- feedback control algorithm, 1064
 - for DO controlling, 1066
- feedforward control algorithm, 1064
- feeding, 798, 1231
- fermentation of complex compounds, 669
- fermentative catabolism, 302
- ferric chloride for conditioning, 1253
- Fick's law, 461
- filamentous bacteria
 - predominance, 1056
 - sludge bulking condition, 1056
 - See also* floc-forming bacteria
- filamentous organisms, 314
- filter presses, 261, 268
 - design, 1275
 - operational aspects, 1279
 - performance, 1275
 - process description, 1273
 - working principle, 1273
 - See also* belt presses
- filter presses operating cycle
 - cake discharge, 1274
 - filling, 1273
 - filtration under maximum pressure, 1274
- filtered COD, 673
- filtration, 169
 - as phosphorus removal mechanism, 170
- final sludge disposal, 254, 274, 1315–1317
 - alternatives, 1321
 - criteria, 1322
 - environmental impact assessment, 1392
 - beneficial land application, 1395
 - incineration, 1394
 - landfarming, 1394, 1395
 - landfill, 1394
 - ocean disposal, 1393

- final sludge disposal (*cont.*)
 land application of sewage sludge and, 1328
 methods, 1215
 monitoring, 1392, 1396
- first-order reaction, 320
 change of concentration, 323
 reaction rate, 322
See also saturation reaction;
 second-order reaction; zero-order reaction
- first-order reaction coefficients
 comparison, 356
 in complete-mix model, 357, 358
 in dispersed flow model, 357, 358
 in plug-flow model, 357, 358
- five-stage Bardenpho process. *See under* Bardenpho process
- fixed aerators, 475
- fixed bed anaerobic reactors, 717
- fixed solids, 35. *See also* volatile solids
- fixed suspended solids
 gross production in reactor, 413
- Flagellates*, 310
- floating aerators, 475
- floating macrophytes, 535
- floating solids removal, 181
- floc
 activated sludge, 841
 BOD values, 312, 313
 DO values, 313
 filamentous bacteria, 1055
 forming bacteria, 1055
 sludge, 875
See also biofilm; biomass growth
- floc-forming bacteria
 pin-point floc condition, 1056
 predominance, 1056
See also filamentous bacteria
- floc-forming organisms, 314
- flocculation, 312, 698, 1248
- flocculent settling, 424
 flocs, 433
 removal efficiency, 433
See also discrete settling; zone settling
- flotation thickening, 1247
- flotation, dissolved air, 257, 1246
- flow estimation, 69
 domestic flow, 74
 industrial wastewater flow, 75
 infiltration flow, 75
 total flow, 75
See also wastewater flowrates
- flow measurements, 27
- flow regularisation of water body, 116
- flow-through lagoons. *See* complete-mix aerated lagoons
- flow variations
 maximum, 26, 27
 minimum, 26, 27
- fluidised bed anaerobic reactor, 720. *See also* expanded bed anaerobic reactor; rotating bed anaerobic reactor
- fluidised bed incinerator, 1379
- flux
 gravity flux, 438, 441
 limiting flux, 439
 underflow flux, 438
- F/M ratio. *See* food-to-microorganism ratio
- foam and scum problems
 causes, 1096
 detection, 1096
- food load, 404
- food-to-microorganism ratio, 404, 841, 1069
- foul odours prevention, 789
- four-stage Bardenpho process. *See under* Bardenpho process
- free ammonia. *See under* ammonia forms distribution
- free water removal, 1243, 1244
- fungi, 34
- gas bubbles attached to floc, 1077
- gas collection system, 1387
- gas transfer
 saturation concentration of gas, 458
 universal gas law, 459
- gas transfer mechanisms
 Fick's law, 461
 interface creation aspects, 463
 interface renewal aspects, 463
 molecular diffusion, 461
 oxygen. *See* oxygen transfer influencing factors
 penetration theory, 462
 turbulent diffusion, 461, 463
 two-film theory, 462
- geometric growth method, 16, 19. *See also* population forecast methods
- geometry, pond. *See* pond geometry
- granulation, 699
- graphical comparison method. *See under* population forecast methods
- gravity aeration
 efficiency coefficient, 484

- effluent concentration, 484
- exposure of air-to-water mass, 482, 483, 484
- exposure of water-to-surrounding air, 482, 483, 484
- influent concentration, 484
- See also* diffused air aeration; gravity aeration; mechanical aeration
- gravity flux, 438, 441, 449–450
- gravity flux curve, 441
- gravity thickeners, 257, 437
- gravity thickening, 1244. *See also* dissolved air flotation, thickening
- grease removal
 - problem of anaerobic filter, 792
 - problem of UASB reactor, 793
- green algae*, 505
- grit, 244, 246
- grit removal, 180. *See also* coarse solids removal
- groundwater contamination, 626, 1338
- head loss, 1146
- heat-dried granular biosolid application, 1355
- heavy metals toxicity, 65
- helminth, 34, 57
 - caused diseases, 52
 - removal, 128
- helminth eggs
 - and protozoan cysts, 1207
 - in the sludge, 606
- helminth eggs removal, 1288
 - efficiency, 604, 606
 - from anaerobic ponds, 604
 - from facultative ponds, 604
 - from maturation ponds, 604
 - from wastewater, 604
 - sedimentation, 604
- heterotrophic active biomass, 962
- heterotrophic bacteria, 81, 88
- heterotrophic bacterial metabolism, 381
- heterotrophic microorganisms, 979
- heterotrophic organisms, carbon source for, 300
- high-rate ponds, 171, 188
- high-rate systems, 716
 - with attached growth
 - expanded/fluidised bed reactors, 710, 719
 - fixed bed reactors, 710, 717
 - rotating bed reactors, 710, 718
 - with dispersed growth
 - baffled reactors, 710, 721
 - expanded granular bed reactors, 710, 723
 - reactors with internal recirculation, 710, 725
 - two-stage reactors, 710, 721
 - upflow sludge blanket reactors, 710, 722
- hindered settling. *See* zone settling
- HLR. *See* hydraulic loading rate
- holomictic lakes
 - dimictic, 143
 - monomictic
 - cold, 143
 - warm, 143
 - oligomictic, 143
 - polimictic, 143
- horizontal-flow rectangular tank, 915. *See also* sedimentation tank with horizontal flow
- horizontal-shaft aerators, 474
- horizontal-shaft centrifuges
 - advantages and disadvantages, 267, 1268
 - co-current, 266
 - counter-current, 266
 - See also* vertical-shaft centrifuges
- hydrated lime, 1305
- hydraulic control option. *See under* activated sludge system
- hydraulic detention time, 396, 566
 - as aerobic digesters design parameter, 1234
 - for UASB reactors, 745
 - in anaerobic filters, 734
 - in three-phase separator, 759
 - See also* solids retention time
- hydraulic loading rate, 1042
 - anaerobic filters, 735
 - for overland flow systems, 819
 - for primary sedimentation tank, 940
 - for secondary sedimentation tanks, 916, 923, 926
 - rotating biological contactors design criteria, 1137
 - submerged aerated biofilters design criteria, 1151
 - trickling filters design criteria, 1123
- hydraulic models (of reactors)
 - batch reactors, 331
 - complete-mix, 92, 331, 332, 337, 341
 - continuous flow conditions, 330
 - dispersed flow, 92, 331, 346
 - first-order reaction coefficients
 - comparison, 356
 - for stabilisation ponds evaluation, 519

- hydraulic models (of reactors) (*cont.*)
 influent characteristics, 361
 intermittent flow conditions, 330
 packed-bed reactors, 332
 plug-flow, 92, 331, 333
 reactors in parallel, 331, 351
 reactors in series, 331, 352
 variable loads influence, 361
- hydraulic overload problems
 causes, 1095
 control, 1096
 detection, 1095
- hydraulic short circuits, 346
- hydrogen sulphide as biogas component, 1225
- hydrogen-using microorganisms, 666
- hydrogenotrophic methanogenesis, 303, 304
- hydrogenotrophic methanogens, 671
Methanobacterium genera, 666
Methanobrevibacter genera, 666
Methanospirillum genera, 666
- hydrolysable COD, 674
- hydrolysis, 169, 369, 555
 and acidogenesis, 665
- hydrolytic acidogenic organisms, 1219
- ICEAS. *See* intermittent cycle extended aeration system
- immobilisation of microorganisms, 698
- implementation costs of wastewater treatment process, 284
- incineration, 276, 277, 278, 1378
 for final disposal, 1394
 for pathogen removal, 1310
See also aerobic digestion; wet air oxidation
- incinerators
 atmospheric emissions from
 acidic gases, 1380
 incomplete combustion products, 1380
 nitrogen oxides, 1380
 volatile organic compounds, 1380
 fluidised bed, 1379
 multiple chamber, 1379
- indicator organisms removal, 499
- industrial BOD, 76
- industrial effluent, 61
 BOD load, 67
 treatment, 743
 UASB reactors, 743
- industrial wastewater
 biological treatment, 61
 BOD loads, 68
 characteristics, 59
 industrial wastewater flow, 30, 75
 characteristics, 67
 water consumption and, 29
 water consumption, 29
See also wastewater flowrates
- industrial wastewaters pollutants
 metals, 63
 toxic and dangerous organic compounds, 66
- inert nitrogenous matter
 particulate, 962
 soluble, 962
- inert organic matter
 particulate, 368
 soluble, 368
- inert residue, 370. *See also* active biomass
- inert solids, 1183
- infiltration
 flow, 28, 75
 rapid, 172, 193
 rates in sewerage systems, 28
 subsurface, 172, 194
 water BOD, 76
See also wastewater flowrates
- influent BOD, 523
 complete-mix aerated lagoons, 565
 facultative aerated lagoons, 555
- influent characteristics (in dynamic state)
 hydraulic overload, 363
 overload of biodegradable substances, 362
 toxic substances, 362
- influent concentration variations
 effect on complete-mix reactor, 366
 effect on plug-flow reactor, 363
- influent distribution in UASB reactors
 distribution compartments, 753
 distribution tubes, 753
 number of distribution tubes, 755
- influent distribution system (for trickling filters)
 fixed, 1124
 rotating, 1125
- influent flow and characteristics, 800
- influent sewage
 biological phosphorus removal and, 991
 Water Research Commission comments, 992
- influent solids, 881
- influent substrate, 372, 392. *See also* effluent substrate

- influent wastewater characteristics, 59, 60, 72, 1138
- inhibiting substances as anaerobic digestion requisites, 1218
- inlet to pond, 627. *See also* outlet of ponds
- inorganic chemical conditioning
 - applied dosages, 1254
 - ferric chloride, 1253
 - lime, 1253
 - See also* sludge conditioning
- inorganic nitrogen, 369. *See also* organic nitrogen
- interface settling velocity, 443
- intermittent cycle extended aeration system, 1029. *See also* alternated aeration activated sludge system; cyclic activated sludge system
- intermittent flow, 843
- intermittent flow systems, 1033. *See also* activated sludge system
- intermittent operation cycles
 - filling, 847
 - idle, 847
 - reaction, 847
 - settling, 847
 - withdrawal, 847
- intermittent operation reactors
 - for biological nitrogen removal, 997
 - advantage, 1003
 - anoxic stage, 1003
 - post-denitrification aspects, 1003
 - pre-denitrification aspects, 1003
 - for combined nitrogen and phosphorus removal, 1015, 1016
- intermittent operation systems, 1023
- intermittent sand filters, 535
- interstitial biomass retention, 700
- in-vessel system composting, 1298
- ionized ammonia. *See under* ammonia forms distribution
- irrigation (treated wastewater reuse), 164
- irrigation systems, crop, 192

- kinematic viscosity, 426, 528
- Kjeldahl method, 45

- lake
 - amictic, 143
 - holomictic, 143
 - meromictic, 143
 - stratification and, 142
- lakes and reservoirs
 - corrective methods for recovery, 149
 - eutrofication, 133
 - phosphorus load estimation, 144
 - temperature profile, 140
 - trophic characterisation, 138
- land application, beneficial
 - agricultural land reclamation, 1396
 - land reclamation, 1395
- land application of biosolids
 - agriculture, 1329
 - limitations, 1335
 - risks, 1335
 - site selection aspects, 1343
- land application of sewage sludge
 - agriculture, 1329
 - beneficial use, 1328, 1329
 - sanitation sector, 1335
 - discard category, 1328
- land disposal systems, 176
 - aquatic-based, 192
 - constructed wetlands, 172, 195
 - crop irrigation, 192
 - overland flow, 172, 194–195
 - rapid infiltration, 172, 193
 - slow infiltration, 192
 - slow-rate, 172, 192–193
 - soil-based, 176, 192
 - subsurface infiltration, 172, 194
- land reclamation, 276, 277, 278, 1395
- land use
 - and water quality, 3
 - eutrophication and, 133, 134
 - population density and, 17
 - See also* catchment area and water quality
- landfarming, 276, 277, 278
 - basic concepts, 1368
 - closure plan, 1371
 - defined, 1367
 - design and operational aspects, 1370
 - environmental monitoring aspects, 1371
 - for final disposal, 1394, 1395
 - selection of areas, 1369
 - site selection criteria, 1369, 1370
- landfill
 - closure, 1389
 - for final disposal, 1394
 - monitoring, 1388
 - sanitary, 276, 277, 278
- landfill design elements
 - gas collection system, 1387
 - landfill bed impermeabilisation, 1386
 - leachate collection system, 1387
 - sizing, 1385
 - stormwater drainage system, 1386

- landfill disposal, 1374
 - co-disposal with urban solid waste, 1382, 1385
 - considerations, 1381
 - environmental impact considerations, 1383
 - exclusive (dedicated) sanitary landfills, 1382, 1384
 - leachate treatment, 1387
 - site selection aspects, 1383
- leachate collection system, 1387
- leachate treatment, 1387
- Liebig's law, 143
- lime
 - for conditioning, 1253
 - hydrated, 1305
 - quicklime, 1253, 1305
 - slaked lime, 1253
 - stabilisation, 273
- limiting flux, 439, 441. *See also* solids flux theory
- limiting nutrient aspects, 143
- limiting solids flux determination, 449
- linear growth method, 16, 18. *See also* population forecast methods
- liquid biosolid application, 1354. *See also* dry biosolid application
- liquid polymers, 1251. *See also* dry polymers
- liquid sludge disposal, 1321
- liquid sludges, 1305
- liquid temperature influence on stabilisation ponds, 511
- loading rates on biological reactors
 - food-to-microorganism ratio, 404
 - sludge age, 407
 - sludge load, 404
 - substrate utilisation rate, 407
 - surface loading rate, 410
 - surface organic load, 410
 - total suspended solids, 405
 - volatile suspended solids, 405
 - volumetric hydraulic load, 410
 - volumetric organic load, 409
- location aspects of stabilisation ponds
 - access conditions, 622
 - area availability, 622
 - area shape, 622
 - area topography, 622
 - facility to purchase land, 622
 - flood levels, 622
 - groundwater level, 622
 - land cost, 622
 - soil characteristics, 622
 - winds, 622
- logistic growth method, 16, 19
- Ludzack-Ettinger process, 998
- macronutrients, 682. *See also* micronutrients
- manual operation aspects of wastewater treatment plants, 1063
- mass balance
 - dynamic state conditions, 329
 - in activated sludge system, 872
 - in sludge treatment, 1194
 - mass accumulation concept, 327, 329
 - representative equations, 327
 - steady state conditions, 329
 - suspended solids, 872
- mass balance (substrate modelling)
 - effluent substrate, 392
 - in complete-mix reactor, 392
 - influent substrate, 392
 - solids balance, 393
 - substrate balance, 393
- mass transfer coefficient, 467
- maturation ponds, 172, 190, 496, 518
 - ammonia removal efficiency, 611
 - bacteria and viruses removal, 579
 - coliform die-off coefficient, 587
 - coliform removal efficiencies, 579
 - helminth eggs removal, 604
 - pathogenic organisms removal, 578
 - See also* polishing ponds; stabilisation ponds
- maturation ponds coliform removal design criteria
 - baffled ponds, 592
 - depth, 592, 596
 - detention time, 592
 - length/breadth ratio, 592
 - ponds in series, 592
- MCRT (mean cell residence time), 396, 840, 1070
- mechanical aeration, 457
 - regulation methods, 1065
 - See also* diffused air aeration
- mechanical aeration systems
 - characteristics, 476
 - oxygen transfer, 474, 475, 477
 - See also* diffused air aeration systems
- mechanical aerators
 - and aerated lagoons, 553
 - and facultative aerated lagoons, 558
 - mixing zone, 558
 - oxygenation zone, 558

- rotation shaft classification, 474
- supporting function-based classification
 - fixed, 475
 - floating, 475
- meromictic lakes, 143
- mesophilic phase in composting process, 1294, 1295
- mesophilic temperature range, 685, 686
- mesotrophic level, 139. *See also* eutrophic level; oligotrophic level
- metabolism
 - anabolism, 301
 - catabolism, 301
 - heterotrophic bacterial, 381
- metallic coagulants
 - aluminium sulphate, 263
 - ferric chloride, 263
 - ferric sulphate, 263
 - ferrous sulphate, 263
 - hydrated lime, 263
 - quicklime, 263
- metals
 - as anaerobic digestion requisites, 1218
 - content in biosolids, 1335
 - removal efficiencies, 1201
 - toxicity, 63, 696
- metals as sludge contaminants
 - metals removal potential, 1198
 - metals sources
 - arsenic, 1200
 - cadmium, 1199
 - chromium, 1199
 - copper, 1199
 - lead, 1200
 - mercury, 1199
 - nickel, 1199
 - selenium, 1200
 - zinc, 1199
- methane as biogas component, 1225
- methane formation
 - acetic acid cleavage, 670, 671
 - acetoclastic methanogenic organisms, 671
 - carbon dioxide reduction, 670, 671
 - from fermentation, 669
 - hydrogenotrophic methanogenic organisms, 671
- methane production
 - in anaerobic sludge digesters, 1230
 - sulphate reduction and, 680
 - wastewater degradation and, 676
 - See also* methane formation
- methanogenesis, 555, 666
 - acetotrophic, 303, 304
 - hydrogenotrophic, 303, 304
- methanogenic microorganisms, 541, 665, 667
 - chemical composition
 - macronutrients, 682
 - micronutrients, 682
 - pH effect, 688
- methanogens
 - acetoclastic, 666, 671
 - hydrogenotrophic, 666, 671
 - in anaerobic digestion process, 1219
 - Methanosarcina* genera, 670
- microbial activity evaluation, 702
- microbial cells, 300
 - energy generation in, 302
 - See also* biological cells
- microbial growth associated temperature
 - mesophilic range, 685
 - psychrophilic range, 685
 - thermophilic range, 685
- microbial mass evaluation, 700, 785
- microbiological analyses of pathogens, 1313
- microbiological indicators, 808
- microbiology of wastewater treatment
 - biological cells, 299
 - energy and carbon sources, 300
 - energy generation in microbial cells, 302
 - metabolism of microorganisms, 301
 - microorganisms and water quality, 298
 - See also* ecology of wastewater , treatment
- Micrococcus*, 979
- micronutrients, 681, 682, 685
- microorganisms
 - and water quality, 298
 - bacteria. *See* bacteria
 - enzymes, 301
 - eukaryotes, 298, 309
 - fungi, 34
 - immobilisation, 698
 - mass, 404
 - metabolism, 301
 - methanogenic, 665
 - prokaryotes, 298, 307
 - protozoa, 35, 309
- microorganisms classification (respiration conditions)
 - facultative, 303
 - strict aerobic, 303
 - strict anaerobic, 303

- microorganisms classification (energy and carbon sources)
 - chemoautotrophs, 301
 - chemoheterotrophs, 301
 - photoautotrophs, 301
 - photoheterotrophs, 301
- microorganisms kingdom
 - basic characteristics, 299
 - Monera*, 298
 - Protists*, 298
- microsieves, 535
- mineralisation process, 1330
- mixed liquor suspended solids, 441, 447, 856, 859
 - as activated system design parameter, 1042, 1044
 - control, 1068
- mixed liquor volatile suspended solids, 841, 856, 859, 1032
- mixing
 - as aerobic digesters design parameter, 1235
 - in anaerobic sludge digesters, 1223
 - in stabilisation ponds, 508, 510
 - requirements in complete-mix aerated lagoons, 570
- MLSS. *See* mixed liquor suspended solids
- MLVSS. *See* mixed liquor volatile suspended solids
- moisture content. *See* thermal drying
- moisture monitoring in composting, 1296
- molecular diffusion, 89, 461
- Monera*, 298. *See also* *Protists*
- monitoring
 - anaerobic reactor
 - digester stability, 781
 - reactor efficiency, 780
 - sludge quantity and quality, 781
 - drying beds, 782
 - overland flow system, 821
 - preliminary treatment, 779
 - programme, 777, 778
- Monod formulation, 383, 384, 862–863, 1001
- monofills, 1384
- multiple chamber incinerator, 1379
- multiplicative regression method, 16. *See also* population forecast methods
- natural wetlands, 195. *See also* constructed wetlands
- nitrate, 45
 - assimilation by algae, 610
 - in the anaerobic zone, 990
 - removal efficiency, 999
- nitrification, 44–45, 375, 610–611
 - alkalinity requirements for, 976
 - and activated sludge, 173, 209
 - and biological nutrient removal, 960
 - as activated sludge system design parameter, 1044
 - as cause behind rising sludge problems, 1077
 - bacteria for, 308
 - chemoautotrophs, 88
 - during aerobic treatment, 886
 - environmental factors influence
 - dissolved oxygen, 967
 - pH, 967
 - temperature, 966
 - toxic or inhibiting substances, 968
 - in conventional activated sludge system, 892
 - kinetics, 965
 - modelling, 1004
 - oxygen demand for, 892
 - oxygen requirements for, 975
 - rate, 971
 - sludge age requirements, 970
 - See also* ammonification; denitrification
- nitrifying bacteria growth, 965
- Nitrobacter* bacteria, 376
- Nitrobacter* genus, 963
- nitrogen
 - based limitations of anaerobic technology, 807
 - discharge guidelines, 960
 - in biosolids, 1330
 - requirements
 - in activated sludge system, 893
 - in anaerobic digestion, 683
 - See also* phosphorus
- nitrogen aspects in
 - sewage treatment, 44
 - TKN, 45
 - water pollution, 44
 - See also* phosphorus; total nitrogen
- nitrogen-based wastewater characteristics
 - ammonia, 33
 - nitrate, 33
 - nitrite, 33
 - organic nitrogen, 33
- nitrogen in raw sewage
 - biomass characterisation, 962
 - nitrogenous matter characterisation, 962
- nitrogen removal, 612
 - activated sludge system, 209, 842, 898

- biological. *See* biological nitrogen removal
- by overland flow systems, 815
- with carbon from endogenous respiration. *See* post-denitrification
- with carbon from raw sewage. *See* pre-denitrification
- See also* nitrogen removal mechanisms; phosphorus removal
- nitrogen removal efficiency, 613–614
 - aerated ponds, 611
 - facultative ponds, 611
- nitrogen removal in ponds
 - ammonia assimilation by algae, 610, 611
 - ammonia stripping, 610
 - denitrification, 610
 - maturation ponds, 611
 - nitrate assimilation by algae, 610
 - nitrification, 610, 611
 - particulate organic nitrogen sedimentation, 610
- nitrogen removal mechanisms
 - ammonification, 170
 - bacterial assimilation, 170
 - break-point chlorination, 170
 - denitrification, 170
 - nitrification, 170
 - stripping, 170
- nitrogenous demand, 376
- nitrogenous matter characterisation
 - inorganic, 962
 - organic, 962
- nitrogenous matter conversion
 - ammonia oxidation (nitrification), 375
 - denitrification, 376
 - Nitrobacter*, 376
 - Nitrosomonas* bacteria, 376
 - See also* carbonaceous matter conversion
- nitrogenous matter, 367
 - inorganic, 369
 - organic, 369
 - See also* carbonaceous matter
- nitrogenous organic matter
 - biodegradable, 962
 - inert, 962
 - See also* carbonaceous organic matter
- Nitrosomonas* bacteria, 376
- Nitrosomonas* genus, 963, 968
- non-biodegradable organic matter. *See* inert organic matter
- non-biodegradable volatile suspended solids, 414
- non-bulking sludge problems
 - causes, 1094
 - control, 1095
 - detection, 1094
 - non-porous diffuser, 477
 - non-settleable solids, 36
 - non-settleable suspended solids, 35. *See also* settleable suspended solids
 - non-volatile solids, 36
 - nucleic acids. *See under* biological cells
 - nutrient availability, of industrial wastewater, 61
 - nutrient control, 210
 - nutrient recommendation in biosolids, 1345
 - nutrient removal
 - biological
 - nitrogen removal, 610
 - phosphorus removal, 615
 - post-treatment of anaerobic effluent, 617, 619
 - nutrient requirements
 - for activated sludge systems
 - nitrogen, 893
 - phosphorus, 893
 - in anaerobic digestion, 681
 - micronutrients, 685
 - nitrogen, 683
 - phosphorus, 683
 - sulphur, 683
- ocean disposal, 1393
- odour problem
 - aerated ponds, 643
 - anaerobic ponds, 541, 639
 - facultative ponds, 640
- odours prevention. *See* foul odours prevention
- OE. *See* oxygenation efficiency
- off-site collection systems, 12
- off-site sewerage
 - domestic sewage, 12
 - industrial effluents, 12
 - infiltration, 12
 - See also* on-site sewerage
- oils and grease based wastewater characteristics, 34
- oligotrophic level, 139. *See also* eutrophic level; mesotrophic level
- on-site sewerage, 11. *See also* off-site sewerage
- on-site systems, 12
- operation and maintenance of ponds
 - inspection and monitoring, 633
 - operation start-up. *See* start-up operations

- operation and maintenance of ponds (*cont.*)
 - operational problems, 638
 - operational staff, 633
- operational control in wastewater treatment plant
 - aims of, 1061
 - automatic control aspects, 1063
 - implementation difficulties, 1061
 - manual operation aspects, 1063
 - problems associated with, 1062
 - See also* process control in wastewater treatment plant
- operational control of anaerobic reactors
 - anaerobic filters operation, 792
 - foul odours prevention, 789
 - health and safety aspects, 776
 - importance of, 774
 - information aspects, 777
 - maintenance aspects, 777
 - operation aspects, 777
 - operational conditions optimisation, 775
 - operational parameters verification, 775
 - operational precautions, 790
 - operational troubleshooting, 799
 - influent flow characteristics, 800
 - preliminary treatment, 801
 - sludge drying beds, 804
 - sludge in reactor, 803
 - UASB reactor performance, 802
 - reactors start-up, 791
 - sludge measurement and characterisation, 785
 - sludge wastage aspects
 - excess sludge production, 786
 - excess sludge wastage, 787
 - system monitoring, 777
 - UASB reactors operation, 793
- operational cycles for sequencing batch reactors design, 1032
- operational problems in activated sludge systems
 - high ammonia concentration, 1101
 - high effluent BOD concentration
 - particulate BOD, 1098
 - soluble BOD, 1099
 - high suspended solids concentration
 - bulking sludge, 1078
 - dispersed sludge, 1092
 - foam and scum, 1096
 - hydraulic overload, 1095
 - non-bulking sludge, 1094
 - pin-point floc, 1091
 - rising sludge, 1075
 - suspended solids concentration, 1097
- operational problems in aerated ponds
 - absence of DO, 643
 - bad odour, 643
- operational problems in anaerobic ponds
 - algae proliferation, 639
 - bad odour, 639
 - insects proliferation, 639
 - obstructed inlet pipe, 639
 - vegetation growth, 639
- operational problems in facultative ponds
 - bad odour, 640
 - cyanobacteria presence, 641
 - high algae concentration, 641
 - insects proliferation, 642
 - scum and floating materials, 640
 - vegetation inside pond, 642
- optimal control, 1065
- order of reaction
 - first-order, 320, 322
 - second-order, 320
 - zero-order, 320, 321
- organelles. *See under* biological cells
- organic carbon removal, 908
- organic contaminants. *See* trace organic contaminants
- organic load
 - aerobic digesters design parameter, 1234
 - influence in facultative ponds, 507
- organic loading rate
 - anaerobic filters, 735
 - as trickling filters design criteria, 1124
 - rotating biological contactors design criteria, 1137
 - submerged aerated biofilters design criteria, 1151
 - UASB reactors, 747
- organic matter
 - anaerobic technology limitations, 806
 - biodegradable, 369
 - biosolid, 1331
 - nitrogenous. *See* nitrogenous organic matter
 - carbonaceous. *See* carbonaceous organic matter
 - decomposition routes, 305
 - soluble, 372
- organic matter-based wastewater characteristics
 - BOD, 33
 - COD, 33
 - TOC, 33
 - ultimate BOD, 33

- organic matter in wastewater
 - easily biodegradable, 308
 - slowly biodegradable, 308
- organic matter removal
 - activated sludge systems for, 942
 - by overland flow systems, 815
 - dissolved organic matter, 183
 - in continuous-flow activated sludge reactor, 855
 - biodegradable solids, 869, 871
 - BOD, 868, 908
 - carbon, 907
 - excess sludge, 881, 887
 - nitrogen, 898
 - organic carbon, 908
 - substrate, 862
 - volatile biodegradable solids, 869
 - volatile solids, 871
 - organic matter in suspension, 183
- organic matter removal mechanisms
 - adsorption, 169
 - hydrolysis, 169
 - sedimentation, 169
 - stabilisation, 169
- organic nitrogen
 - ammonia and, 45
 - biodegradable, 369
 - inert, 369
 - See also* inorganic nitrogen; Total Kjeldahl Nitrogen
- organic nitrogenous matter
 - biodegradable, 962
 - inert, 962
- organic overloading aspects in facultative ponds, 533
- organic phosphorus removal, 615, 616
- organic pollutants and biosolids quality, 1337
- organic pollution controlling measures, 115
 - allocation of other uses for water body, 116, 117
 - flow regularisation, 116
 - treated wastewater aeration, 116
 - wastewater treatment, 115–116
 - water body aeration, 116
- organic pollution, 93
- organic polymers
 - characteristics, 1249
 - composition and surface charges, 1249
 - dosages, 1252
 - dry polymers, 1250
 - for sludge conditioning, 1249
 - liquid polymers, 1251
- organic solids, dissolved, 372
- orthophosphates, 34, 47. *See also* polyphosphates
- OTR. *See* oxygen transfer rate
- outlet of ponds, 630. *See also* inlet to pond
- overland flow, 172, 194–195, 818
- overland flow method
 - advantages, 814
 - disadvantages, 815
- overland flow system
 - configuration, 817
 - considerations, 814
- overland flow system construction
 - aspects
 - monitoring, 821
 - sewage distribution, 819
 - storage, 819
 - vegetation selection, 821
- overland flow system design criteria
 - ground slope, 819
 - hydraulic loading rate, 819
 - operation cycle, 819
 - slope length, 818
 - soil classification, 819
 - nitrogen removal, 815
 - organic matter removal, 815
 - pathogenic organism removal, 816
 - phosphorus removal, 816
 - suspended solids removal, 815
- oxidation
 - ammonia, 375
 - biochemical, 377
 - organic matter, 91
- oxidation ditches, 997
 - aerobic zone, 1001
 - ammonia concentration, 1001
 - anoxic zone, 1001
 - Carrousel-type, 909–913, 1001
 - denitrification efficiency, 1002
 - DO concentration aspects, 1001
 - Pasveer-type, 909–913, 1001
- oxidation reactions in sewage treatment
 - electron acceptor concept, 303
 - electron donor concept, 302
 - under aerobic conditions, 303
 - under anaerobic conditions, 303
- oxidative catabolism, 302
- oxygen consumption
 - benthic (sediment) demand, 87
 - nitrification, 88
 - organic matter oxidation, 87
 - See also* dissolved oxygen consumption; oxygen production

- oxygen consumption parameters
 - BOD, 38, 39
 - COD, 42
 - relationship between, 43
 - TOC, 43
 - ultimate BOD, 40, 41
- oxygen consumption rate
 - steady-state method (aeration tests), 480
 - unsteady-state method (aeration tests), 481
- oxygen demand
 - aerobic digesters design parameter, 1235
 - carbonaceous, 887
 - for nitrification, 892
 - in ATAD, 1302
 - See also* BOD; COD; oxygenation efficiency; ultimate BOD
- oxygen production, 91
 - atmospheric reaeration, 88
 - photosynthesis, 89
 - steady-state method (aeration tests), 480, 481
 - See also* DO, consumption; oxygen consumption
- oxygen requirements
 - activated sludge system
 - carbonaceous oxygen demand, 887
 - oxygen demand for nitrification, 892
 - facultative aerated lagoons, 557
 - for nitrification, 975
 - in complete-mix aerated lagoons, 569
- oxygen saturation concentration, 484
- oxygen transfer
 - diffused air aeration systems, 478
 - efficiency, 471
 - steady-state method (aeration tests), 480
 - unsteady-state method (aeration tests), 481
- oxygen transfer by mechanical aerators
 - adequate submergence concept, 475
 - submergence
 - above optimal, 475
 - below optimal, 475
- oxygen transfer influencing factors
 - atmospheric pressure, 466–467
 - DO concentration, 466–467
 - reactor characteristics, 468
 - temperature, 466–467
 - wastewater characteristics, 468
- oxygen transfer mechanisms (mechanical aerators)
 - transfer at air-liquid interface, 474
 - transfer by air bubbles, 474
 - transfer to droplets, 474
- oxygen transfer rate
 - diffused-air aeration systems, 478
 - mechanical aeration systems, 477
 - under operating (field) conditions, 468
 - under standard conditions, 468
- oxygenation efficiency, 470
 - complete-mix aerated lagoons, 570
 - facultative aerated lagoons, 558
- oxypause, 506
- ozonization as pathogen removal
 - mechanism, 218
- packed-bed reactors, 332
- packing media
 - anaerobic filters, 731
 - height for anaerobic filters, 734
 - submerged aerated biofilters, 1147
 - trickling filters design criteria, 1126
- PAO. *See* phosphorus accumulating organisms
- particulate BOD
 - in activated sludge system, 865, 867
 - in facultative aerated lagoons, 554
 - See also* particulate effluent BOD
- particulate BOD concentration problems
 - causes, 1098
 - control, 1098
 - detection, 1098
- particulate carbonaceous matter, 368
- particulate COD, 673
- particulate effluent BOD, 521
 - complete-mix aerated lagoons, 569
 - facultative aerated lagoons, 557
 - in facultative aerated lagoons, 556
- particulate nitrogenous matter, 369
- particulate organic matter, 368
- particulate organic nitrogen sedimentation, 610
- particulate phosphorus, effluent, 996
- pasteurisation, 273, 1309
- Pasveer-type oxidation ditches, 909, 911, 913, 1001
- pathogen reduction in sludge, 1287
 - aerobic digestion aspects, 1236
 - anaerobic digestion aspects, 1221
 - organisms monitoring aspects, 1312
 - re-growth avoidance aspects, 1312
 - sludge requirements for, 1312
 - sludge sampling for microbiological analyses
 - after sampling measures, 1314
 - before sampling measures, 1314
 - See also* pathogen removal

- pathogen reduction mechanisms in sludge, 1289
 - biological, 1292
 - chemical, 1291
 - radiation, 1293
 - thermal, 1291
 - See also* pathogen removal mechanisms
- pathogen reduction processes in sludge
 - alkaline stabilisation, 1305
 - ATAD, 1302
 - comparison, 1311
 - composting, 1293
 - incineration, 1310
 - pasteurisation, 1309
 - thermal drying, 1309
 - wet oxidation, 1310
- pathogen removal, 216
 - activated sludge system, 842
 - and biosolids quality, 1336
 - bacteria and viruses, 579
 - by overland flow systems, 816
 - coliform removal, 580, 592
 - effluent coliform removal, 579
 - for agricultural recycling, 1322
 - helminth eggs, 604
 - high DO concentration, 579
 - high pH, 579
 - post-treatment of anaerobic effluent, 617, 619
 - process description, 578
 - protozoan cysts and helminth eggs, 579
 - solar radiation, 579
 - stabilisation ponds for, 499
 - systems operational control aspects, 1310
 - See also* pathogen reduction
- pathogen removal from sludge
 - exposure and contamination hazards, 1287
 - helminth eggs and protozoan cysts, 1287, 1288
 - pathogen reduction aspects, 1287
 - protozoan, 1288
 - viruses, 1288
- pathogen removal mechanisms
 - adverse environmental conditions, 169
 - artificial, 218
 - chlorination, 218
 - disinfection, 169
 - filtration, 169
 - land treatment, 218
 - maturation ponds, 218
 - membranes process, 219
 - natural, 218
 - ozonization, 218
 - sedimentation, 169
 - ultraviolet radiation, 169, 218
 - See also* pathogen reduction mechanisms
- pathogen survival
 - in soil, 1211
 - on crops, 1212
- pathogenic microorganisms contamination, 79
 - bacterial decay kinetics, 126
 - coliform removal efficiencies, 128
 - controlling of, 128
- pathogenic organisms
 - bacteria, 49
 - concentration monitoring, 1312
 - concentrations in different countries, 1290
 - detection, 49
 - helminths, 49
 - protozoans, 49
 - viruses, 49
- pathogenic organisms in sludge
 - bacteria, 1208
 - density of, 1209
 - health implications, 1210
 - helminth eggs, 1207
 - protozoan cysts, 1207
 - viruses, 1209
- PE. *See* population equivalent
- pelletisation, 1215
- penetration theory, 462. *See also* two-film theory
- per capita load, 57
- PFRP. *See* Processes to Further Reduce Pathogens
- pH
 - aspects in composting, 1297
 - based wastewater characteristics, 34
 - concentration in anaerobic sludge digesters, 1230, 1231
 - for pathogenic organisms removal, 579
 - range for ammonia, 46
- pH effect on
 - acid-producing bacteria, 688
 - biological phosphorus removal, 990
 - denitrification, 985
 - methanogenic microorganisms, 688
 - nitrification, 967
- Phoredox. *See under* combined nitrogen and phosphorus removal
- phosphate, 47
 - ortho, 34
 - poly, 34
 - precipitation, 615, 616
 - release, 988

- phosphorus
- accumulating organisms, 987
 - based limitations of anaerobic technology, 807
 - discharge guidelines, 959
 - for microorganisms growth, 48, 49
 - fraction in
 - active biomass, 994
 - suspended solids, 993
 - volatile suspended solids, 994
 - in sludge, 1331
 - load estimation into lakes and reservoirs, 144
 - removal. *See* phosphorus removal
 - See also* nitrogen
- phosphorus-based wastewater
- characteristics
 - inorganic, 34
 - organic, 34
- phosphorus concentration estimation in
- water body
 - maximum allowable load estimation, 145
 - trophic level estimation, 145
- phosphorus forms
- inorganic
 - orthophosphates, 47
 - polyphosphates, 47
 - organic, 47
- phosphorus in wastewater
- particulate, 48
 - soluble, 48
- phosphorus removal
- activated sludge system and, 210, 842
 - biological. *See* biological phosphorus removal
 - by overland flow systems, 816
 - from wastewater, 148
 - model. *See* biological phosphorus removal modelling
 - organic phosphorus, 615, 616
 - phosphate precipitation, 615, 616
 - See also* nitrogen removal
- phosphorus removal mechanisms
- bacterial assimilation, 170
 - filtration, 170
 - precipitation, 170
- phosphorus requirements in
- activated sludge system, 893, 894
 - anaerobic digestion, 683
- phosphorus sources
- stormwater drainage, 144
 - wastewater, 144
- photoautotrophs, 301
- photoheterotrophs, 301
- photosynthesis, 507
- autotrophs, 89
 - process, 503
 - See also* respiration
- phototrophic organisms, energy source for, 300
- physical-chemical treatment, 422
- physical unit operations (wastewater treatment), 167. *See also* biological unit processes; chemical unit processes
- pigmented flagellated algae*, 505
- pin-point floc condition, 1056
- pin-point floc problems
- causes, 1091
 - detection, 1091
- planning period. *See* design horizon
- planning studies. *See* preliminary studies
- plug-flow
- behaviour of activated sludge reactors, 910, 912
 - effluent coliform concentration, 580
 - regime. *See under* water quality models
- plug-flow ponds
- coliform die-off coefficient, 589
 - coliform removal efficiency, 580, 581
- plug-flow reactors, 331, 333
- and selectors configuration, 1057, 1058
 - biodegradable substances with
 - first-order reaction, 333, 334
 - zero-order reaction, 333, 334
 - concentration profiles, 334
 - conservative substances, 333
 - dispersion, 347
 - effluent BOD concentration, 518, 519
 - first order reaction coefficients, 357, 358
 - influent concentration variations, 363
 - steady-state conditions, 335
 - transient analysis, 364
 - See also* complete-mix reactors
- point-source pollution, 10
- polishing ponds, 496
- and anaerobic effluent post-treatment, 618
 - for effluent post-treatment, 812
 - UASB reactors followed by, 618
 - See also* maturation ponds
- pollutant loads, 69. *See also* BOD loads
- pollutants removal mechanisms (wastewater)
- nitrogen, 170

- organic matter, 169
- pathogen, 169
- phosphorus, 170
- solids, 169
- pollution by organic matter, 79
- polyacrylamides, 1249
- polyelectrolytes, 1270
- polymer dosages, 1252
- polyphosphates, 34, 47, 48. *See also* orthophosphates
- pond dikes, 623–625
- pond dikes construction aspects
 - external slope, 624
 - freeboard, 624
 - internal slope, 624
 - internal slopes protection, 624
 - materials of slope, 624
 - slope corners, 624
 - slope crest, 624
 - stormwater drainage, 624
 - waterproofing, 624
- pond effluents polishing technologies
 - floating macrophytes, 535
 - intermittent sand filters, 535
 - microsieves, 535
 - physical–chemical removal, 536
 - rock filters, 535
- pond excavation aspects
 - usable excavated material, 623
 - useless excavated material, 623
- pond geometry
 - anaerobic ponds design criteria, 542, 545
 - facultative ponds design criteria, 512, 517
- ponds loading, 633
- population density and land use, 17
- population equivalent, 67
- population forecast, 69
- population forecast and sewage system
 - adhesion index, 13
 - coverage index, 13
 - physical, geographical or topographical conditions, 13
 - sewage system implementation stages, 13
- population forecast methods
 - decreasing growth rate, 14, 16, 19
 - employment and utility services, 16, 17
 - geometric growth, 14, 16, 19
 - graphical comparison, 16, 17
 - linear growth, 14, 16, 18
 - logistic growth, 15–16, 19
 - multiplicative regression, 14, 16
 - ratio and correlation, 16, 17
- porous diffuser, 477. *See also* non-porous diffuser
- post-denitrification
 - disadvantage, 1000
 - reaeration zone, 1000
 - system design criteria, 1003
 - Wuhrmann process, 1000
 - See also* pre-denitrification
- post-treatment of anaerobic effluent
 - activated sludge for, 848, 1042, 1045
 - additional BOD removal, 617, 618
 - nutrient removal, 617, 619
 - pathogenic organism removal, 617, 619
 - submerged aerated biofilters for, 1144
- post-treatment ponds. *See* polishing ponds
- power level
 - concept, 472
 - facultative aerated lagoons with, 556
- power requirements for complete-mix aerated lagoons, 570
- precipitation
 - as phosphorus removal mechanism, 170
 - chemical, 1319
 - for COD removal, 675
 - phosphate, 615, 616
- pre-denitrification
 - advantages and disadvantage, 1000
 - in anoxic zone, 998
 - Ludzack-Ettinger process, 998
 - system design, 1003, 1007
 - See also* post-denitrification
- preliminary studies
 - design horizon and staging periods, 281
 - economical and financial study, 281, 284
 - environmental impact assessment, 281
 - influent wastewater
 - qualitative characterisation, 279
 - quantitative characterisation, 279
 - polluting loads quantification, 280
 - population forecast studies, 279
 - preliminary design, 281, 283
 - process flowsheet, 281
 - selection of the proposed alternative, 281
 - site selection, 280
 - treatment alternatives, 280
 - treatment objectives, 280
 - unit layout and design, 281

- preliminary treatment, 166, 180, 801
 as anaerobic digestion requisites, 1217
 coarse solids removal, 180
 grit removal, 180
 monitoring and operation, 779
 sedimentation applications, 421
See also primary treatment; secondary treatment
- primary clarifiers, 1182
- primary ponds
 coliform die-off coefficient, 587
 facultative ponds, 517, 523
See also secondary ponds
- primary sedimentation
 as biological nitrogen removal system design criteria, 1005
 for wastewater treatment, 1319
- primary sedimentation tank, 956
 effluent loads and concentrations
 BOD, 945
 SS, 945
 TKN, 945
 followed by activated sludge system, 940
See also secondary sedimentation tank
- primary sedimentation tank design considerations, 939
 with mechanised sludge removal, 940
 without mechanised sludge removal, 941
- primary sludge, 244–246, 1182. *See also* chemical sludge; secondary sludge
- primary treatment, 166
 CEPT, 181
 floating solids removal, 181
 sedimentation applications, 421
 septic tanks, 182
 settleable suspended solids removal, 181
See also preliminary treatment; secondary treatment
- principle of equity. *See under* wastewater discharges quality standards
- process control in wastewater treatment plant
 automated process control, 1063
 classical process control methods, 1071
 control algorithms
 expert system control
 feedback control, 1064, 1065
 feedforward control, 1064
 optimal control, 1065
 dissolved oxygen control
 diffused air aeration control, 1065
 feedback control, 1066
 mechanical aeration control, 1065
 process control variables
 input, 1063
 manipulated, 1064
 measured, 1064
 output, 1063
 state, 1063
 process indicators control
 F/M ratio control, 1069
 MLSS control, 1068
 sludge age control, 1070
 process monitoring aspects, 1073
 solids control
 excess sludge flow, 1068
 return sludge flow, 1067
See also operational control in wastewater treatment plant
- Processes to Further Reduce Pathogens, 1286, 1364
- Processes to Significantly Reduce Pathogens, 1364
- prokaryotes, 298, 307. *See also* eukaryotes
Protists, 298. *See also* *Monera*
- protozoa, 34
 caused diseases, 52
 removal, 128, 1288
See also microorganisms
- protozoa in biological wastewater treatment
Amoebas, 310
Ciliates, 310
Flagellates, 310
 role of, 310
Pseudomonas, 313, 979
- PSRP. *See* Processes to Significantly Reduce Pathogens
- psychrophilic temperature range, 685
- quicklime, 1253, 1305, 1306. *See also* slaked lime
- radiation treatment for pathogen removal, 1293
- rapid infiltration, 172, 193
- rapidly biodegradable matter
 carbonaceous, 369
 nitrogenous, 369
- RASS. *See* return activated sludge suspended solids
- rate of reaction for
 first-order reactions, 322
 saturation reactions, 324
 zero-order reactions, 321, 322
- ratio of oxygen utilisation, 471
- raw sewage, 961

- raw sludge, 259
 - comparison with anaerobically digested sludge, 1217
 - heating power, 1226
 - See also* digested sludge
- RBC. *See* rotating biological contactors
- reaction kinetics in wastewater treatment processes
 - first-order reaction, 320, 322
 - reaction rate, 320
 - saturation reactions, 324
 - second-order reaction, 320
 - temperature influence, 326
 - zero-order reaction, 320, 321
- reactor
 - aerobic. *See* aerobic reactor
 - anaerobic. *See* anaerobic reactor
 - biological, 404
 - for biological phosphorus removal, 1018
 - for biological wastewater treatment, 319
 - volume, 949
 - with nitrification, 1007
 - with pre-denitrification, 1007
 - with solids recirculation, 400
- reactor hydraulics, 319
 - batch reactors, 331
 - complete-mix, 331, 332, 337, 341
 - continuous flow conditions, 331
 - dispersed flow, 331, 346
 - hydraulic model, 330
 - intermittent flow conditions, 331
 - packed-bed reactors, 332
 - plug-flow, 331, 333
- reactors
 - in parallel, 331, 351
 - in series, 331, 352
- reactor types, comparison between
 - first-order reaction, 355
 - saturation reaction, 356
 - steady state conditions
 - biodegradable substances with a zero-order reaction, 355
 - conservative substances, 355
 - zero-order reaction, 355
- reactor with final sedimentation unit
 - and with solids recirculation, 394
 - and without solids recirculation, 394
- reactor with internal recirculation
 - expanded bed zone, 726
 - mixing zone, 726
 - polishing zone, 726
 - recirculation system, 726
- reactor with suspended biomass
 - and with solids recirculation, 400
 - and without solids recirculation, 400, 401
- reaeration, 86–91, 480
- reaeration coefficient, 113
 - as a function of hydraulic characteristics, 101
 - average tabulated values, 101
 - correlation with river flow, 102
- reaeration kinetics
 - mathematical formulation, 99
 - oxygen saturation concentration, 99
 - reaeration coefficient, 101
 - temperature influence, 104
 - See also* deoxygenation kinetics
- reagent concentration, 320
- recalcitrant COD, 673
- recirculated sludge
 - excess sludge flow, 877
 - fixed underflow situation, 876
 - increase of underflow, 876
 - return sludge flow, 877
- recirculation, 1006
 - activated sludge, 354, 872
 - solids (biomass modelling), 393
- recovery zone, 83
- rectangular secondary sedimentation tank, 916–916, 956
- rectangular sedimentation tanks, 939
- reduction of nitrate. *See* denitrification
- regression analysis for population forecasting, 16, 17
- removal efficiencies
 - flocculent settling, 433
 - pathogenic and indicator organisms, 499
- respiration, 86, 91, 503, 507. *See also* oxidation of organic matter; photosynthesis
- resuspension of sludge, 88
- return activated sludge suspended solids, 872
- return sludge, 856–857
 - flow, 877, 1067
 - ratio, 872
 - SS in, 874
- ribonucleic acid, 299
- rising sludge, 1078. *See also* bulking sludge; dispersed sludge problems
- rising sludge problems, causes of
 - denitrification, 1075
 - emulsified grease and oil, 1078
 - gas bubbles, 1077
 - septic sludge, 1077

- rising sludge problems detection, 1075
- river flow (DO model data)
 - critical flow, 110
 - mean flow, 109
 - minimum flow, 109
 - observed flow, 109
- river water quality, 90
- RNA, 299
- rock filters, 535
- rotating bed anaerobic reactor, 718. *See also* expanded bed anaerobic reactor; fluidised bed anaerobic reactor
- rotating biological contactors, 215, 237, 1135
- rotating biological contactors design criteria
 - biofilm control, 1138
 - dissolved oxygen levels, 1139
 - hydraulic loading rates, 1137
 - influent wastewater characteristics, 1138
 - operational flexibility, 1139
 - organic loading rates, 1137
 - sludge production, 1140
 - wastewater temperature, 1138
- rotation shaft aerators
 - horizontal-shaft, 474
 - vertical-shaft, 474
- ROU. *See* ratio of oxygen utilisation
- SAB. *See* submerged aerated biofilters
- SAF. *See* submerged aerated filters
- salts toxicity, 693
- sanitary landfill, 276, 277, 278, 1382
- sanitation sector, biosolids use, 1335
- saturation concentration
 - of gas, 458
 - temperature influence on, 467
 - See also* oxygen saturation concentration
- saturation reaction, 321–326
 - change of concentration, 325
 - reaction rate, 324
- SBR. *See* sequencing batch reactors
- screened material, 244
- screening, 169
- scum, 244, 246
- second-order reactions, 320, 321. *See also* first-order reactions; zero-order reactions
- secondary ponds
 - coliform die-off coefficient, 587
 - facultative ponds, 517, 523, 547
 - See also* primary ponds
- secondary sedimentation tank, 840, 1006
 - area requirement, 954
 - central-feeding circular tank, 915
 - circular, 917, 939, 955
 - denitrification in, 937
 - Dortmund tank, 915, 918
 - for activated sludge system design, 1044
 - for trickling filters design criteria, 1128
 - horizontal-flow rectangular tank, 915
 - hydraulic overloading problems, 1095
 - nitrification in, 937
 - rectangular, 916, 939
 - rising sludge problem, 1076
 - settleability ranges, 921
 - sludge volume index values, 921
 - solids overloading problems, 1094
 - surface area determination
 - hydraulic loading rates, 916
 - loading rates based approach, 920
 - solids flux theory, 920
 - solids loading, 916
 - See also* primary sedimentation tank
- secondary sedimentation tank design
 - circular, 939
 - design for clarification, 923–929
 - design for thickening, 923, 928–929
 - design principles, 922
 - effluent weirs, 937
 - rectangular, 939
 - sidewater depth, 937
 - weir loading rate, 938
- secondary sludge, 244, 245, 1183. *See also* chemical sludge; excess sludge; primary sludge
- secondary treatment, 166
 - biological stage, 183
 - organic matter removal, 182
 - sedimentation applications, 421
 - See also* preliminary treatment; primary treatment
- secondary treatment systems
 - activated sludge system, 183, 202
 - aerobic biofilm reactors, 183, 211
 - anaerobic reactors, 183, 198
 - land disposal systems, 183, 191
 - stabilisation ponds, 183, 184
- sedimentation
 - for helminths egg removal, 604
 - of suspended solids, 169
 - organic matter, 169
 - pathogens, 169
 - pond. *See* sedimentation pond

- sedimentation applications
 - grit removal, 421
 - primary, 421
 - secondary, 421
 - settling after chemical precipitation, 422
 - thickening, 422
- sedimentation compartment in three-phase separator
 - apertures to, 759
 - hydraulic detention time, 759
- sedimentation in wastewater treatment
 - physical–chemical, 422
 - preliminary, 421
 - primary, 421
 - secondary, 421
 - sludge treatment, 422
- sedimentation pond, 565. *See also*
 - complete-mix aerated lagoons
- sedimentation pond design criteria
 - depth, 570, 571
 - detention time, 570, 571
- sedimentation tank, 181, 199
 - primary. *See* primary sedimentation tank
 - secondary. *See* secondary sedimentation tank
 - suspended solids concentration profiles, 442
 - with critical load, 443
 - with thickening and clarification
 - overload, 443
 - with underload, 443
 - zone, 427
 - zone settling, 437
- sedimentation tank with horizontal flow
 - discrete settling, 429
 - flocculent settling, 434
 - hydraulic surface loading rate, 428
 - overflow rate, 428
 - sedimentation zone, 427
 - settling column, 428
 - settling velocity, 428
- seed sludge, 791–792
 - characterisation, 796
 - volume for start-up, 794
- selectors, biological. *See* biological selectors
- self-purification
 - assimilation capacity of rivers, 80
 - effluent discharges above assimilative capacity, 80
 - stream. *See* stream self purification zones, 85
- separate sewerage system, 11. *See also*
 - combined sewerage
- septic sludge cause behind rising sludge
 - problems, 1077
- septic tank, 177, 182
 - floatable solids retention, 714
 - settleable solids retention, 714
- septicity, 1089
- sequencing batch activated sludge reactor, 1044
- sequencing batch reactors, 173, 207–209, 237, 846
 - design example, 1035
 - for biological nitrogen removal, 997, 1026
 - advantage, 1003
 - anoxic stage, 1003
 - post-denitrification aspects, 1003
 - pre-denitrification aspects, 1003
 - for biological phosphorus and nitrogen removal, 1028
 - for biological phosphorus removal, 1027
 - for BOD removal, 1027
 - for combined nitrogen and phosphorus removal, 1015, 1016
 - operational cycle, 1024
 - process principles, 1023
- sequencing batch reactors design criteria
 - aeration equipment, 1033
 - mathematical model, 1033
 - MLVSS concentration, 1032
 - operational cycles, 1032
 - sludge age, 1032
 - supernatant removal device, 1034
- sequencing batch reactors design
 - methodology
 - design sequence, 1035
 - input data
 - kinetic and stoichiometric coefficients, 1035
 - MLVSS concentration, 1035
 - reactor height, 1035
 - sludge age, 1034
- settleability, 36
 - evaluation, 446
 - secondary sedimentation tanks, 921
 - sludge, 44
- settleable solids, 36
- settleable suspended solids, 35
 - removal, 181
 - See also* non-settleable suspended solids
- settling tank, 204, 839
 - circular with central feeding, 423
 - rectangular with horizontal flow, 422

- settling types
 - compression, 424
 - discrete, 424, 425
 - flocculent, 424
 - hindered, 424
 - zone settling, 436
- settling velocity in
 - discrete settling, 425
 - flocculent settling, 433
 - zone settling, 443
- sewage
 - domestic, 30
 - solids in. *See* solids in sewage
- sewage distribution methods
 - advantages, 820
 - high-pressure sprinklers, 820
 - limitations, 820
 - low-pressure sprinklers, 820
 - pipng with spaced openings, 819
- sewage flow, 23, 26
 - domestic, 13
 - off-site, 11–12
 - on-site, 11–12
- sewage sludge
 - beneficial use, 1329
 - land application, 1329
 - treatment, 1375
- sewage system types
 - combined, 11
 - off-site, 11, 12
 - on-site, 11, 12
 - separate, 11
- sewage treatment
 - attached biomass growth, 316
 - bacterial growth concept, 382
 - dispersed biomass growth, 316
 - nitrogen aspects, 44
 - oxidation reactions in, 303
 - removal of pathogenic organisms, 218
- sewage treatment plants
 - health risks, 776
- sewage treatment systems
 - characteristics, 226
 - high loading systems, 382
 - low loading systems, 382
 - very high loading systems, 382
- sewerage system
 - and population forecast, 13
 - infiltration rates in, 28
- sewage, wastewater
 - off-site, 11
 - on-site, 11
- sidewater depth, 937
- silting. *See under* urban occupation consequences
- site selection, 1343
 - aspects of preliminary studies, 280
 - criteria for landfarming, 1369, 1370
 - landfill, 1383
- slaked lime, 1253. *See also* quicklime
- sludge thickening, 422
- slopes. *See* pond dikes
- slow rate system, 172
 - crop irrigation systems, 192
 - slow infiltration systems, 192
- slowly biodegradable matter
 - carbonaceous, 369
 - nitrogenous, 369
- SLR. *See* solids loading rate
- sludge
 - aerobic, 1320
 - anaerobic, 1320
 - anaerobically digested, 259, 1217
 - biological, 245
 - chemical, 244, 245, 248
 - Class-A, 1289, 1291
 - Class-B, 1289
 - dewatered, 262, 1306
 - digested, 259
 - liquid, 1305
 - liquid phase, 244
 - mixed, 245
 - primary, 244, 245, 246
 - raw, 259, 1217
 - secondary, 244, 245
 - solid phase, 244
- sludge accumulation
 - anaerobic ponds, 547
 - anaerobic reactors, 786
 - complete-mix aerated lagoons, 571
 - facultative aerated lagoons, 560
 - facultative ponds and, 533
 - stabilisation ponds, 645
- sludge age, 205, 396, 407, 875
 - activated sludge systems, 843, 857
 - complete-mix aerated lagoons, 566
 - controlling aspects, 1070
 - for nitrification, 970
 - for sequencing batch reactors design, 1032
 - influence on phosphorus removal, 990
 - relationship with activated sludge system, 897
 - selection for activated sludge reactor design, 906

- sludge age based activated sludge
 - conventional, 843–844, 849, 857
 - extended aeration, 843–845, 849, 857
- sludge bulking, 1055, 1056
- sludge bulking causes
 - low dissolved oxygen, 1056
 - low F/M ratio, 1056
 - low pH, 1056
 - nutrient deficiency, 1056
 - septic influent wastewater, 1056
- sludge characteristics
 - dewatering stage, 1172
 - digestion stage, 1172
 - thickening stage, 1172
- sludge conditioning, 1321
 - affecting factors, 1247
 - effects of, 1247
 - inorganic chemical conditioning, 1253
 - sludge treatment stage, 263
 - See also* metallic coagulants
- sludge contaminants
 - health implications of pathogens, 1210
 - metals, 1197, 1198
 - pathogenic organisms, 1197, 1206
 - density, 1209
 - helminth eggs and protozoan cysts, 1207
 - pathogenic bacteria, 1208
 - survival aspects, 1211
 - viruses, 1209
 - trace organics, 1197, 1205
- sludge density, 1179
- sludge dewaterability, 1235, 1236, 1247
- sludge dewatering, 1322
 - belt-filter presses, 1280
 - by centrifuge, 1265, 1269
 - by sludge drying beds, 1258
 - filter presses for, 1273
 - in drying beds, 1259
 - in UASB reactors, 764
 - reasons for, 1243
- sludge dewatering processes (mechanised)
 - belt press, 261, 269
 - centrifuges, 261, 266
 - characteristics, 263
 - filter press, 261, 268
 - vacuum filter, 261, 267
- sludge dewatering processes (natural)
 - characteristics, 263
 - drying beds, 261, 264
 - drying lagoon, 264
 - sludge lagoons, 261
- sludge digester
 - anaerobic, 1219, 1221, 1233
 - mixing in, 1223
 - operation and control, 1229
 - thermophilic, 1239
- sludge digestion in activated sludge system, 869
- sludge digestion, aerobic
 - composting, 1239
 - conventional digestion, 1234
 - digestion with pure oxygen, 1238
 - thermophilic digestion, 1238
- sludge digestion, anaerobic
 - biogas production aspects, 1224
 - pathogens reduction aspects, 1221
 - process description, 1219
 - reaction kinetics, 1219
 - requisites
 - inhibiting substances, 1218
 - metals, 1218
 - preliminary treatment, 1217
 - solids concentration, 1218
 - temperature and heat balance, 1225
- sludge disinfection, 270, 274, 275
- sludge disposal, 244
 - application in agriculture, 1333
 - criteria, 1322
 - final disposal, 1215, 1315–1317, 1328
 - landfill disposal, 1374, 1381
- sludge disposal alternatives
 - advantages and disadvantages, 277
 - agricultural reuse, 276
 - environmental impacts related to, 278
 - final disposal, 1321
 - incineration, 276
 - land reclamation, 276
 - landfarming, 276
 - monitoring indicators, 1397
 - ocean disposal, 276
 - sanitary landfill, 276
 - sustainable aspects, 1316
- sludge disposal alternatives impacts
 - aesthetic and social problems, 1397
 - air pollution, 1397
 - food chain contamination, 1397
 - soil pollution, 1397
 - transmission of diseases, 1397
 - water pollution, 1397
- sludge disposal methods
 - thermal drying, 1374
 - wet air oxidation, 1375

- sludge disposal monitoring plan
 - data collection methodology, 1399
 - data tabulation, analysis and evaluation, 1400
 - environmental critical levels, 1399
 - final remarks, 1402
 - impact indicators selection, 1399
 - impacts definition, 1398
 - information to population, 1402
 - monitoring goals, 1398
 - reports, 1402
 - sampling frequency, 1399
 - sampling points, 1399
- sludge disposal sites monitoring
 - parameters, 1398
 - sources, 1398
- sludge drying beds, 804
 - advantages and disadvantages, 263
 - draining medium, 1258
 - evaporation, 265
 - general aspects, 1259
 - operational aspects, 1265
 - percolation, 265
 - problems and solution in, 1266
 - supporting layer, 1258
- sludge drying beds design
 - loading rates for, 1260
 - productivity concept, 1261
- sludge drying lagoons, 264, 265
- sludge flocs, 875
- sludge generated in wastewater treatment, 251
- sludge heating. *See* thermal drying,
- sludge incineration. *See* incineration
- sludge lagoons, 261, 265, 266
- sludge land disposal. *See* landfarming
- sludge load, 404
 - for UASB reactors, 748
- sludge management, 1167
 - and wastewater treatment, relationship between, 1318
 - biosolid management, 1317
 - contaminants in sludge, 1198
 - environmental impacts considerations, 1325
 - final destination monitoring, 1327
 - in anaerobic ponds, 547
 - in stabilisation ponds, 499
 - managerial system, 1327
 - qualitative and quantitative control, 1326
 - sludge handling within treatment plant, 1326
 - sludge production in liquid phase, 244, 245
 - sludge wastage
 - from liquid phase, 245
 - from solid phase, 245
 - storage aspects, 1326
 - transportation aspects, 1326
 - trends in countries, 1316
 - EU, 1317
 - USA, 1317
- sludge measurement and characterisation
 - microbial activity evaluation, 785
 - microbial mass evaluation, 785
- sludge microbiological quality
 - Class-A sludges, 1289
 - Class-B sludges, 1289
 - Type-C, 1289
 - Type-D, 1289
- sludge mixing
 - in anaerobic digesters, 1223
 - through mechanical mixer, 1223
 - through pumped recirculation, 1223
 - through recirculation, 1223
- sludge organic contaminants, 1205
- sludge pathogenicity, 1286, 1287
- sludge processing alternatives
 - capital costs, 1324
 - considerations
 - environmental legislation, 1321
 - relationship between wastewater treatment and sludge management, 1318
 - sludge production scale, 1320
 - soils and regional agriculture, 1321
 - wastewater quality, 1319
 - wastewater treatment technology, 1319
 - criterion for sludge treatment selection
 - conditioning, 1321
 - dewatering, 1322
 - final disposal, 1322
 - liquid sludge disposal, 1321
 - pathogen removal, 1322
 - stabilisation, 1321
 - environmental impact, 1325
 - flexibility, 1323
 - operational costs, 1324
 - operational performance, 1323
 - processing costs, 1325
- sludge production, 1320
 - as submerged aerated biofilters design criteria, 1151
 - biological solids production, 877
 - characteristics, 1140

- excess sludge production, 879
 - in primary treatment, 1182
 - in secondary treatment, 1183
 - in trickling filters, 1129
 - in UASB reactors, 763
 - in wastewater treatment systems, 1170, 1171
- sludge production calculation
 - primary sludge production, 1182
 - secondary sludge production, 1183
- sludge quality influencing factors
 - environmental conditions, 874
 - sludge ages, 874
- sludge recirculation, 411, 840
 - activated sludge, 872
 - on suspended solids, 400
- sludge relationships
 - between flow, concentration and load, 250
 - between solids levels and water content, 248
 - concentration of dry solids, 249
 - density, 249
- sludge removal from stabilisation ponds
 - sludge removal techniques, 647, 650
 - advantages and disadvantages, 652
 - dredging, 649
 - hydraulic sludge discharge pipe, 649
 - manual, 648
 - mechanical, 648
 - mechanised scraping and pumping, 648
 - pumping from raft, 651
 - robotic system, 651
 - septic tank, 649
 - sludge volume, 646
- sludge removal, primary tank-based, 940
- sludge resuspension, 88
- sludge retention processes, 872
- sludge sampling system, 761
- sludge settleability, 446
 - for secondary sedimentation tanks, 923, 924
- sludge solids, 1179
- sludge stabilisation, 87
 - anaerobic digestion process, 1214
 - biological
 - aerobic, 259, 1215
 - anaerobic, 259, 1215
 - chemical, 259, 1214, 1215
 - for agricultural recycling, 1321
 - incineration, 1378
 - thermal, 259, 1214, 1215
- sludge stabilisation and disposal methods
 - aerobic digestion, 260
 - anaerobic digestion, 260
 - chemical treatment, 260
 - composting, 260, 271
 - lime stabilisation, 260, 273
 - pasteurisation, 273
 - thermal drying, 260
 - thermal treatment, 274
 - thermophilic aerobic digestion, 272
- sludge thermal drying. *See* thermal sludge
- sludge thickening, 1218
 - as water removal process, 1243
 - criteria for secondary sedimentation tanks, 922–929
 - dissolved air flotation thickening, 1246
 - gravity thickening, 1244
 - thickening stage characteristics, 1172
- sludge thickening methods
 - belt presses, 257
 - centrifuges, 257
 - dissolved air flotation, 257
 - gravity thickeners, 257
- sludge treatment, 244
 - alkaline stabilisation, 1305
 - environmental impact considerations, 222
 - mass balance in, 1194
 - sedimentation applications, 422
 - solids capture, 1181
 - systems, 256
- sludge treatment stages
 - conditioning, 254
 - dewatering, 254
 - disinfection, 254, 270
 - final disposal, 254, 274
 - stabilisation, 254
 - thickening, 254
- sludge uses and requirements in different countries, 1289
- sludge volume index
 - DSVI, 447–448
 - maximum achievable SVI, 448
 - SSVI, 447
 - SSVI_{3,5}, 447–448
 - values for secondary sedimentation tanks, 921
- sludge wastage
 - from liquid phase, 245
 - from solid phase, 245
 - problem of anaerobic filter, 793
- sludge withdrawal system, 762

- SMA. *See* specific methanogenic activity
- soil
- assimilation aspects, 191
 - biosolids land application, 1333
 - cation exchange capacity, 1332
 - Class-I, 1338
 - Class-II, 1338
 - Class-III, 1339
 - Class-IV, 1339
 - Class-V, 1339
 - conditioner, 1331, 1346
 - erosion control aspects, 1333, 1334
 - humus properties, 1332
 - mineral phosphorus in, 1331
 - nitrogen element in, 1330
 - permeability, 626
 - quality aspects, 623
 - soil aptitude for biosolid land application, 1338
 - depth, 1339
 - drainage and hydromorphism, 1339
 - erosion, 1339
 - slope, 1339
 - structure, 1339
 - texture, 1339
 - topography, 1339
 - water table, 1339
 - soil-based systems, 176
 - overland flow, 194–195
 - rapid infiltration, 193–194
 - slow-rate systems, 192–193
 - subsurface infiltration, 194
 - soil mechanisms for pollutants removal
 - biological, 191
 - chemical, 191
 - physical, 191
 - soils and regional agriculture
 - considerations for sludge processing, 1321
 - solid by-products
 - biological sludge
 - aerobic, 247
 - anaerobic, 247
 - chemical sludge, 244, 248
 - coarse solids, 246
 - grit, 244, 246
 - primary sludge, 244, 246
 - screened material, 244
 - scum, 244, 246
 - secondary sludge, 244
 - solids loading rate, 916, 1042
 - for secondary sedimentation tanks, 924, 926
 - solid pollutants removal mechanisms
 - adsorption, 169
 - screening, 169
 - sedimentation, 169
 - solid wastes
 - landfill co-disposal with, 1385
 - solids, biological. *See* biological solids
 - solids capture, 1181
 - solids concentration as anaerobic digestion
 - requisites, 1218
 - solids distribution in activated sludge
 - system, 946
 - biological solids generation, 947
 - influent solids, 947
 - solids flux curves, 442
 - solids flux theory, 437
 - applied flux, 440
 - flux concentration conditions
 - high concentration, 439
 - intermediate concentration, 439
 - low concentration, 439
 - for secondary sedimentation tanks
 - design, 920
 - gravity flux, 438
 - limiting flux, 439
 - underflow flux, 438
 - solids in sewage
 - classification
 - by chemical characteristics, 36
 - by settleability, 36
 - by size, 35
 - dissolved, 33, 35
 - fixed, 33, 35
 - inorganic, 33
 - organic, 33
 - suspended
 - non-settleable, 35
 - settleable, 35
 - volatile, 33, 35
 - solids levels and water content
 - relationship, 248
 - solids recirculation
 - activated sludge system, 841
 - and biomass modelling, 393
 - reactor with, 394
 - reactor without, 394
 - solids retention
 - floatable, 714
 - settleable, 714
 - of submerged aerated filter, 1146
 - solids retention time, 205, 396, 840, 1070, 1146. *See also* hydraulic detention time
 - soluble and particulate COD, 673

- soluble BOD, 521, 523
 - in conventional activated sludge system, 945
 - in facultative aerated lagoons, 554
 - See also* soluble COD
- soluble BOD concentration problems
 - causes, 1099
 - control, 1099
 - detection, 1099
- soluble carbonaceous matter, 368
- soluble COD, 673. *See also* soluble BOD
- soluble effluent BOD, 521
 - complete-mix aerated lagoons, 567
 - facultative aerated lagoons, 554, 557
 - in activated sludge system, 863, 865
- soluble influent BOD
 - facultative aerated lagoons, 557
- soluble nitrogenous matter, 369
- soluble organic matter, 368
- soluble phosphorus, effluent, 996
- SOTE. *See* standard oxygen transfer efficiency
- SOTR. *See* standard oxygen transfer rate
- specific methanogenic activity (SMA)
 - test considerations, 708
 - test description, 703
 - test importance, 703
- spray nozzle cleaning, 1284
- SRB. *See* sulphate-reducing bacteria
- SRT. *See* solids retention time
- SS. *See* suspended solids
- stabilisation
 - for agricultural recycling, 1321
 - organic matter, 169
 - sludge. *See* sludge stabilisation
- stabilisation ponds
 - anaerobic ponds, 540
 - anaerobic/facultative ponds, 171, 186, 495, 496
 - characteristics, 497
 - coliform removal design criteria, 592
 - colour characteristics, 534
 - complete-mix aerated lagoon, 496
 - complete-mix aerated lagoon – sedimentation pond systems, 171, 188
 - design parameters for, 500
 - environmental conditions influence. *See* environmental impact on stabilisation ponds
 - evaluation, 519
 - facultative aerated lagoon, 171, 187, 496
 - facultative pond, 171, 184, 495–496, 502
 - for BOD removal, 498
 - for warm-climatic regions, 495
 - high rate ponds, 171, 189
 - maturation ponds, 172, 190, 496
 - nitrogen removal in, 610
 - operation and maintenance procedures, 632
 - operational characteristics, 534
 - pathogenic and indicator organism removal efficiencies, 499
 - pathogenic organisms removal, 578, 604
 - polishing ponds, 496
 - post-treatment alternative, 617
 - sludge accumulation characteristics, 645
 - sludge management aspects, 499, 644
 - sludge removal from, 646
- stabilisation ponds construction
 - bottom of ponds, 626
 - bottom waterproofing, 627
 - cleaning aspects, 623
 - deforestation aspects, 623
 - excavation aspects, 623
 - inlet devices, 627
 - outlet devices, 630
 - pond dikes, 623
 - ponds location, 621
 - slopes, 623
 - soil permeability aspects, 626
 - soil quality aspects, 623
- staging periods, 282
- standard oxygen transfer efficiency, 471
- standard oxygen transfer rate, 469
- standards for wastewater discharge. *See* wastewater discharge quality standards
- start-up of anaerobic reactors
 - anaerobic filters, 792
 - UASB reactors, 793
- start-up operations
 - anaerobic ponds, 637
 - facultative ponds, 638
 - ponds loading, 633
 - ponds-in-series systems, 638
- steady state of mass balance, 329
- steady-state method (aeration tests)
 - oxygen consumption rate, 480
 - oxygen production rate, 480
 - oxygen transfer coefficient, 480
- step feed, 352
- step feeding, 1058
- stirrers, 1005
- Stokes law, 425
- storage of biosolids, 1352

- stormwater drainage
 - as phosphorus source, 144
 - control, 147
 - system, 1386
 - stratification, 142
 - influence on algae behavior, 509
 - thermal. *See* thermal stratification
 - stream self purification, 79, 81. *See also*
 - pollution by organic matter
 - stream self-purification zones
 - active decomposition, 81, 83
 - clean water, 81, 84
 - degradation, 81, 82
 - recovery, 81, 83
 - Streeter–Phelps model, 90–91
 - BOD in river, 112
 - deoxygenation coefficient, 113
 - dissolved oxygen
 - in river, 110
 - in wastewater, 111
 - saturation concentration, 114
 - DO sag curve, 104
 - minimum allowable dissolved oxygen
 - concentration, 115
 - reaeration coefficient, 113
 - river flow, 109
 - travel time, 113
 - ultimate BOD in wastewater, 112
 - velocity of water body, 113
 - wastewater flow, 110
- Streptococcus*, 56
- strict aerobic organisms, 303
 - strict anaerobic organisms, 303
- stripping mechanism. *See* ammonia stripping
- submerged aerated biofilter, 214, 237
 - aeration system, 1148
 - configuration, 825
 - considerations, 824
 - construction aspects, 1152
 - design criteria, 825
 - energy consumption aspects, 1149
 - filter medium washing aspects, 1149
 - flow direction aspects
 - aeration demand, 1147
 - co-current flow, 1146
 - counter-current flow, 1146
 - head loss evolution, 1146
 - hydraulic behaviour, 1146
 - solids retention capacity, 1146
 - for anaerobic effluent post-treatment, 1144
 - gas phase, 1143
 - liquid phase, 1143
 - packing material, 1147
 - pre-treatment component, 1144
 - primary treatment component, 1144
 - secondary treatment component, 1144
 - solid phase, 1143
 - UASB reactors and, 1144
 - with granular mediums, 1143
 - with structured beds, 1143
 - See also* rotating biological contactors; trickling filters
 - submerged aerated biofilters design criteria
 - hydraulic loading rate, 1151
 - operational aspects, 1153
 - organic loading rate, 1151
 - substrate assimilation and bacterial growth
 - kinetics, 389
 - substrate diffusion rates, 687
 - substrate modelling
 - effluent substrate, 392
 - in complete-mix reactor, 392
 - influent substrate, 392
 - mass balance in reactor, 392
 - solids balance, 393
 - substrate balance, 393
 - substrate oxidation, 888
 - substrate removal
 - activated sludge system, 862
 - rate, 391
 - substrate representation
 - effluent, 372
 - influent, 372
 - substrate utilisation rate, 407
 - subsurface flow wetlands, 196
 - subsurface infiltration, 172, 194
 - sulphate-reducing bacteria
 - Desulfobacter* genera, 667
 - Desulfobacterium* genera, 667
 - Desulfobulbus* sp. genera, 667
 - Desulfococcus* genera, 667
 - Desulfomonas* sp. genera, 667
 - Desulfonema* genera, 667
 - Desulfosarcina* genera, 667
 - Desulfotomaculum* genera, 667
 - Desulfovibrio* genera, 667
 - sulphate reduction, 667, 680
 - sulphide toxicity, 694
 - sulphur requirements in anaerobic
 - digestion, 683
 - sulphite-reducing *clostridia*, 56
 - supernatant quality aspects of aerobic
 - digesters, 1235, 1236
 - supernatant removal device, 1034

- supporting layer for sludge drying beds, 1258
- surface aeration. *See* mechanical aeration
- surface flow wetlands, 196
- surface loading rate (reactor load), 410
- surface organic load, 410, 512, 513
- surface water contamination, 1338
- surplus sludge. *See* excess sludge
- survival of pathogens. *See* pathogens survival
- suspended biomass, 400
- suspended biomass reactors, 1114
- suspended BOD
 - in activated sludge system, 865
- suspended organic matter
 - complete-mix aerated lagoons, 567
 - facultative aerated lagoons, 554
- suspended solids, 371, 1179
 - in effluent, 992
 - in the reactor, 401
 - non-settleable, 35
 - phosphorus fraction determination in, 993
 - production, 898
 - removal, 815, 871
 - settleable, 35
 - See also* dissolved solids; volatile suspended solids
- suspended solids concentration
 - activated sludge system, 857, 866
 - concentration profiles, 442
 - effluent BOD, 403
 - effluent substrate, 401, 402
 - facultative aerated lagoons, 556, 557
 - from UASB reactors, 751, 752
 - influent BOD, 403
 - influent substrate, 401
 - with solids recirculation, 400
- suspended solids concentration problems
 - bulking sludge, 1078
 - dispersed sludge, 1092
 - foam and scum, 1096
 - hydraulic overload, 1095
 - non-bulking sludge, 1094
 - other problems, 1097
 - pin-point floc, 1091
 - rising sludge, 1075
- suspended solids treatment
 - grit removal, 170
 - land disposal, 170
 - screening, 170
 - sedimentation, 170
- sustainable sludge disposal alternatives, 1316
- SVI. *See* sludge volume index
- SWD. *See* sidewater depth
- synthesis predominance, 377, 378
- synthesis stage
 - bacterial growth, 380
 - biochemical oxidation, 378
- secondary treatment, 166. *See also* preliminary treatment; primary treatment
- TC. *See* total coliforms
- temperature
 - aerobic digesters design parameter, 1235
 - aspects in composting, 1296
 - aspects of anaerobic sludge digestion, 1225
 - microbial growth associated
 - mesophilic range, 685
 - psychrophilic range, 685
 - thermophilic range, 685
 - rotating biological contactors design criteria, 1138
 - temperature influence on
 - activated sludge systems, 896
 - anaerobic digestion, 685
 - bacterial growth, 686, 687
 - biological phosphorus removal, 990
 - biomass growth rate, 686
 - denitrification, 984
 - deoxygenation kinetics, 99
 - enzymatic reaction rates, 687
 - microbial population, 686
 - nitrification, 966
 - oxygen transfer
 - influence on mass transfer, 467
 - influence on saturation concentration, 467
 - reaeration kinetics, 104
 - substrate diffusion rates, 687
- tertiary ponds, 587
- tertiary treatment, 166
- TF. *See* trickling filters
- theoretical oxygen demand. *See* TOD
- thermal drying, 260
 - advantages, 1285
 - as sludge disposal methods, 1374
 - biosolids management and, 1336
 - for pathogen removal, 1309
 - for sludge drying, 1309
- thermal drying processes
 - direct, 1374
 - indirect, 1374
 - mixed, 1374

- thermal inversion, 509
- thermal stabilisation, 259, 1214. *See also*
 - biological stabilisation; chemical stabilisation
- thermal stratification, 508, 509
- thermal treatment
 - for pathogen removal, 1291
 - of sludge, 274
- thermocline, 509
- thermophilic aerobic digestion, 270
 - advantages, 1239
 - autothermal, 1302
 - disadvantages, 1239
- thermophilic phase in composting process, 1294
- thermophilic temperature range, 685–686
- thermotolerant coliforms, 53, 54, 55
- thickened sludges, dry solids levels in, 258
- thickening. *See* sludge thickening
- three-phase separator
 - apertures to sedimentation compartment, 759
 - biogas production evaluation, 757
 - hydraulic detention time, 759
 - separation of gases, 757
 - separation of solids, 758
- three-stage Phoredox. *See* A²O process
- TKN. *See* Total Kjeldahl Nitrogen
- TKN/COD ratio, 992
- TOC, 33, 38, 43
- TOD, 38, 379. *See also* BOD; COD; ultimate BOD
- total coliforms, 53–55
- total effluent BOD, 521
 - in activated sludge system, 865
- Total Kjeldahl Nitrogen, 33, 892
 - ammonia, 45
 - ammonia forms distribution, 46
 - organic nitrogen, 45
- total nitrogen
 - ammonia, 33
 - nitrate, 33
 - nitrite, 33
 - organic nitrogen, 33*See also* nitrogen; total phosphorus
- total organic carbon. *See* TOC
- total phosphorus
 - inorganic
 - ortho, 34
 - poly, 34
 - organic, 34*See also* total nitrogen
- total solids, 1179
- total suspended solids
 - gross production in reactor, 413
 - inorganic (fixed) fraction, 411
 - net production in reactor, 415
 - organic (volatile) fraction
 - biodegradable, 411
 - non-biodegradable, 411
- toxic materials, 692
- toxic substances influence
 - on denitrification, 985
 - on nitrification, 968
- toxicity
 - ammonia, 694
 - industrial wastewater, 61
 - metals, 696
 - salts, 693
 - sulphide, 694
 - water. *See under* eutrofication
- trace organic contaminants, 1205
- transportation, biosolids, 1353
- treatability, industrial wastewater, 61
- trickling filters, 211–214, 237
 - configuration, 823
 - considerations, 822
 - construction aspects, 1130
 - design criteria, 824
 - high rate, 213
 - low rate, 211
 - operational aspects, 1131
 - See also* rotating biological contactors; submerged aerated biofilters
- trickling filters design criteria
 - BOD removal efficiency, 1128
 - hydraulic loading rate, 1123
 - influent distribution system, 1124
 - organic loading rate, 1124
 - packing medium, 1126
 - secondary sedimentation tanks, 1128
 - sludge production, 1129
 - underflow collection system, 1127
 - ventilation, 1127
- trickling filters types
 - high rate, 1122
 - intermediate rate, 1122
 - low rate, 1120
 - roughing, 1123
 - super high rate, 1122
- trophic levels
 - association with water uses, 141
 - eutrophic, 139
 - eutrophication and, 139
 - hypereutrophic, 139
 - mesotrophic, 139
 - ultraoligotrophic, 139

- TS. *See* total solids
- TSS. *See* total suspended solids
- turbulent diffusion, 89, 461, 463
- two-film theory, 462. *See also* penetration theory
- two-stage anaerobic reactor, 721
- Type-C sludges, 1289
- Type-D sludges, 1289
- UASB-activated sludge system, 849
- UASB reactors, 172, 198, 200, 659, 722–724, 1320
- and submerged aerated biofilters, 1144
 - BOD removal efficiencies, 750, 751
 - characteristics, 740
 - COD removal efficiencies, 750, 751
 - configurations
 - treating industrial effluents, 743
 - treating low-concentration sewage, 743
 - followed by polishing ponds, 618
 - for effluent post-treatment, 811
 - for post-treatment of anaerobic effluent, 1042, 1045
 - limitations, 741
 - performance, 802
 - process principles, 741
 - sludge dewatering, 764
 - sludge production aspects, 762–763
 - SS concentration estimation, 751, 752
 - wastewater pre-treatment, 764
 - See also* EGSB reactors
- UASB reactors construction aspects
- construction materials, 766
 - corrosion protection, 766
 - reinforced concrete reactors, 767
 - steel reactors, 767
 - reactor height, 765
- UASB reactors design criteria
- biological loading rate, 748
 - discharge system, 761
 - effluent collection, 760
 - gas system, 761
 - hydraulic detention time, 745
 - influent distribution system, 753
 - organic loading rate, 747
 - reactor efficiencies, 750
 - sludge loading rate, 748
 - sludge sampling system, 761
 - sludge withdrawal system, 762
 - three-phase separator, 756
 - upflow velocity and reactor height, 749
 - volumetric hydraulic load, 745
- UASB reactors start-up
- coarse solids removal, 794
 - considerations and criteria
 - acclimatisation, 795
 - biogas production, 795
 - environmental factors, 795
 - seed sludge volume, 794
 - temperature, 795
 - volumetric hydraulic load, 794
 - grease removal, 793
 - procedure during, 798
 - procedure preceding, 796
- UCT process, 1015, 1016
- ultimate biochemical oxygen demand. *See* ultimate BOD
- ultimate BOD, 33, 38, 40. *See also* BOD; COD; TOC
- facultative aerated lagoons, 557
- ultraviolet radiation for pathogen removal, 169, 218
- unaerated facultative ponds, 554
- underflow collection system for trickling filters design, 1127
- underflow flux, 438, 449, 450
- unitary sewerage. *See* combined sewerage
- universal gas law, 459
- University of Cape Town process. *See* UCT process
- unsteady-state method (aeration tests), 480
- oxygen consumption rate, 481
 - oxygen production rate, 481
 - oxygen transfer coefficient, 481
- upflow anaerobic sludge blanket reactor. *See* UASB reactors
- upflow velocity
- anaerobic filters, 732
 - for UASB reactors, 749
- urban occupation consequences
- sewage, 136
 - silting, 135
 - urban stormwater drainage, 136
- urban occupation, 135. *See also* agricultural occupation; woods and forests occupation
- urban wastewater treatment
- European Community Directive, 163
- vacuum filter, 261, 267
- van't Hoff-Arrhenius theory, 326
- ventilation for trickling filters design, 1127
- vertical-shaft aerators, 474
- vertical-shaft centrifuges, 1268. *See also* horizontal-shaft centrifuges
- VFA. *See* volatile fatty acids

- virus, 34
 - caused diseases, 52
 - pathogenic, 1209
 - removal from sludge, 1288
- volatile acids
 - acetic, 667
 - alkalinity, 690
 - butyric, 667
 - concentration in anaerobic sludge
 - digesters, 1230
 - formic, 667
 - intermediate, 669
 - propionic, 667
 - See also* volatile fatty acids
- volatile biodegradable solids, 869
- volatile fatty acids, 663
- volatile solids, 36
 - destruction, 1180
 - reduction aspects of aerobic digesters, 1235–1236
 - removal, 871
 - See also* fixed solids
- volatile suspended solids, 405, 898
 - active, 371
 - biodegradable, 371, 411
 - concentration in complete-mix aerated lagoons, 567
 - gross production in reactor, 413, 414
 - inactive, 371
 - mixed liquor (MLVSS), 841
 - net production in reactor, 414
 - non-biodegradable, 371, 411
 - phosphorus fraction in, 994
 - removal, 871
- volumetric hydraulic load, 410
 - for UASB reactors, 745
- volumetric organic load, 409
 - as anaerobic ponds design criteria, 542
- VSS. *See* volatile suspended solids
- WAO. *See* wet air oxidation
- waste sludge. *See* excess sludge
- waste stabilisation pond systems. *See* stabilisation pond systems
- wastewater
 - aeration, 116
 - biodegradability, 42
 - concentration, 57, 58
 - control, 147
 - degradation, 676
 - flow, 27
 - pre-treatment in UASB reactors, 764
 - production and industrial wastewater flow, 30
 - quality considerations, 1319
 - wastewater characteristics
 - alkalinity, 34
 - chlorides, 34
 - flowrates, 11
 - oils and grease, 34
 - organic matter, 33
 - pH, 34
 - total nitrogen, 33
 - total phosphorus, 34
 - total solids, 33
 - wastewater composition
 - characteristics. *See* wastewater characteristics
 - domestic sewage, 58
 - parameters defining wastewater quality, 35
 - per capita load, 57
 - quality parameters, 30
 - relationship between load and concentration, 57
 - wastewater discharges
 - impact on water bodies, 79
 - wastewater discharges quality standards, 152
 - domestic sewage discharge standards, 164
 - European Community Directive, 163
 - examples, 162
 - in developing countries, 154
 - institutional development, 161
 - principle of equity, 159
 - stepwise implementation, 157, 158, 160
 - WHO recommended guidelines, 163, 164
 - wastewater flowrate
 - domestic, 12
 - industrial, 29
 - infiltration, 28
 - wastewater quality defining parameters
 - carbonaceous organic matter, 37
 - indicators of faecal contamination, 35
 - indicators of organic matter, 35
 - nitrogen, 35, 44
 - pathogenic organisms, 49
 - phosphorus, 35, 47
 - solids, 35
 - wastewater sewerage
 - off-site, 11
 - on-site, 11
 - wastewater treatment, 116
 - aeration tests, 478
 - anaerobic digestion, 663
 - analysis criteria, 217
 - and sludge management, relationship between, 1318

- biological. *See* biological wastewater treatment
- ecology, 306
- environmental impact considerations, 222
- levels
 - preliminary, 165, 166, 167, 180
 - primary, 165, 166, 167, 181–182
 - secondary, 166, 167, 182–184
 - tertiary, 166
- microbiology, 298
- pathogen removal efficiency, 56
- pollutant removal efficiency, 166
- pollutants removal mechanisms, 169
- sedimentation applications, 421
- settling types, 423
- urban, 163
- with phosphorus removal, 148
- See also* preliminary studies
- wastewater treatment (DO model consideration)
 - activated sludge, 111
 - anaerobic treatment, 111
 - biofilm reactors, 111
 - effluents subjected to final reaeration, 111
 - facultative or maturation ponds, 111
 - primary treatment, 111
- wastewater treatment operation and process
 - biological unit processes, 168
 - chemical unit processes, 168
 - physical unit operations, 167
- wastewater treatment plants
 - associating UASB and SAB, 1144
 - BOD and, 40
 - flowrate variations, 26
 - sludge characteristics, 1172
 - sludge production, 1170
 - urban wastewater contribution to, 12
- wastewater treatment processes
 - equipment requirement, 237
 - mass balance in, 327
 - sludge generation in, 251
 - See also* pathogen removal mechanism
- wastewater treatment systems
 - activated sludge, 173, 202
 - advantages and disadvantages, 238
 - aerobic biofilm reactors, 174, 211
 - anaerobic reactors, 173, 198
 - comparative analysis, 238
 - comparison between, 220
 - land disposal, 172, 191
 - operational system need, 777
 - selection aspects, 219
 - sludge production function, 245
 - stabilisation ponds, 171, 184
 - submerged aerated biofilter, 1142
 - trickling filters, 1119
- wastewater treatment technology
 - biological treatment, 1320
 - chemical precipitation, 1319
 - primary sedimentation, 1319
- waterbodies quality standards, 152
- water body
 - assimilation capacity, 80
 - layers
 - epilimnion, 142
 - hypolimnion, 142
 - thermocline, 142
 - stratification, 142
 - wastewater discharges impact on, 79
- water-borne diseases, 49–50, 52
- water consumption
 - as a function of domestic flow, 21
 - industrial wastewater flow, 29
 - influencing factors, 22
- water content and solids levels
 - relationship, 248
- water cycle, 5
- water flows, 26, 27. *See also* flow variations
- water hygiene diseases, 52. *See also* faecal oral transmission
- water in the sludge
 - adsorbed water, 249
 - capillary water, 249
 - cellular water, 249
 - free water, 249
- water pollution, 3, 8
 - and DO balance, 84
 - and DO consumption, 80
 - by organic matter. *See* organic pollution
 - diffuse, 10
 - nitrogen and, 44
 - nitrogen aspects, 44
 - pathogenic microorganisms
 - contamination, 125
 - point-source, 10
 - pollutants sources and effects, 9
 - See also* self-purification
- waterproofing of pond's bottom
 - asphalt layer, 627
 - clay layer, 627
 - plastic geomembranes, 627
- water quality models
 - hydraulic models, 91
 - simplified models, 91
 - Streeter–Phelps model, 90, 91
- water quality
 - and land use, 3
 - and microorganisms, 298

- water quality (*cont.*)
 - requirements, 5
 - river, 90
 - water use and, 7
 - See also* catchment area and water quality
- water-related disease, 49
- water-related infections, transmission of, 50
- water removal
 - processes
 - dewatering, 1243
 - thickening, 1243
 - thermal drying, 1284
 - types
 - adsorbed water, 1243–1244
 - capillary water, 1243–1244
 - cellular water, 1243–1244
 - free water, 1243–1244
- water temperature influence on stabilisation ponds, 511
- water use, 5
 - and quality requirements, 7
- weir loading rate, 938
- wet air oxidation, 1375–1378
 - for pathogen removal, 1310
 - high pressure oxidation, 1376
 - intermediate pressure oxidation, 1376
 - low pressure oxidation, 1376
- wetlands
 - constructed, 172, 195–196
 - horizontal flow, 197
 - vertical flow, 197
- WHO guidelines for reuse of treated wastewater, 164
- wind influence on stabilisation ponds, 509
- windrow composting, 271, 1239, 1297
- winds. *See under* location aspects of stabilisation ponds
- woods and forests occupation, 134. *See also* agricultural occupation; urban occupation
- worker's health and safety programme
 - defined health and safety policy, 776
 - health and safety training, 777
 - health committee, 776
- Wuhrmann process, 1000
- WWTP. *See* wastewater treatment plants
- zero-order reaction, 320
 - change of concentration, 322
 - reaction rate, 321
 - See also* first-order reactions; second-order reactions
- zone settling
 - settling in column, 436
 - solids flux theory, 437
 - zone settling velocity (ZSV), 443
 - See also* discrete settling; flocculent settling
- Zoogloea ramigera*, 313
- ZSV. *See under* zone settling