

Scoping Study: Faecal Sludge Treatment Plants in South-Asia and sub-Saharan Africa

October 2019



Project Partners

eawag
aquatic research ooo



Funding

BILL & MELINDA
GATES *foundation*

Scoping Study: FSTPs in SA and SSA

Eawag / Sandec October 2019

This report summarizes results of a scoping study of existing faecal sludge treatment plants in South Asia and sub-Saharan Africa. The Swiss Federal Institute of Aquatic Science and Technology (Eawag) was the project leader, with funding from the Bill and Melinda Gates Foundation (BMGF). Delvic Sanitation Initiatives (Delvic) in Senegal and the Environmental and Public Health Organization (ENPHO) in Nepal were the project partners for the scoping study.

Authors:

Marius Klingler, Amadou Gueye, Anjali Manandhar Sherpa, Linda Strande

Contributors:

Mingma Sherpa, Miriam Englund, Rajendra Shrestha, Becaye Sidi Diop, Bipin Dangol

Suggested Citation:

Klingler, M., Gueye, A., Manandhar Sherpa, A., Strande, L. (2019). Scoping Study: Faecal Sludge Treatment Plants in South-Asia and sub-Saharan Africa. eFSTP Project Report.

All information on the eFSTP project including this report can be found at: www.sandec.ch/efstp

Disclaimer

The information in this report is based on remote desk-based studies combined with one-day field visits. Some of the difficulties that were faced in the reporting include that the actual operation of FSTPs can frequently be open to interpretation. It is necessary to visit in-person to understand operating conditions; however, a one-day visit is only representative of that actual day.

Frequently, the original design of FSTPs and the actual operating conditions are different, based on the day-to-day reality on the ground. The loading cycle descriptions and diagrams are estimates made by the project team based on operator and manager interviews and, whenever available, logbook records and might differ from original designs and actual operating conditions. The operating cycle diagram (present in the factsheets) is an example of how a loading cycle looks like, but obviously cannot capture the variable conditions.

Copyright



The content of this document is licensed under a Creative Commons Attribution 4.0



International Licence. As long as the source is indicated, this material may be freely copied, redistributed and modified. Further information on the licence is available at:

<http://creativecommons.org/licenses/by/4.0/>

FSTP in SA and SSA: a scoping study

Eawag / Sandec October 2019

Table of Content

Background.....	5
Identified Challenges and Reasons for Failures:	5
Project Objectives.....	5
Scoping Study.....	6
Methodology.....	6
Analysis of Results	7
The Way Forward.....	9
FSTP Factsheets	11
Jhenaidah, Bangladesh.....	12
Faridpur, Bangladesh	13
Sakhipur, Bangladesh	14
Khulna, Bangladesh	15
Kushtia, Bangladesh.....	16
Sourgoubila, Burkina Faso	17
Zagtouli, Burkina Faso.....	18
Kossodo, Burkina Faso	19
Bhubaneshwar, India.....	20
Karunguzhi, India.....	21
Devanahalli, India	22
Puri, India	23
Korhogo, Ivory Coast.....	24
Gulariya, Nepal.....	25
Lubhu, Nepal	26
Tivaouane Peulh, Senegal	27
Cambèrene, Senegal.....	28
Niayes, Senegal	29
Rufisque, Senegal	30
Chazanga, Zambia	31
Supplemental Information	32

List of Tables

Table 1 Summary of the landscaping study results in SA and SSA.....	6
---	---

Scoping Study: FSTPs in SA and SSA

Eawag / Sandec October 2019

Abbreviations

3AS	Association des Acteurs de l'Assainissement du Sénégal
ABR	Anaerobic Baffle Reactor
AF	Anaerobic Filter
AID	Action In Development Foundation
AIT	Asian Institute of Technology
AMRUT	Atal Mission for Rejuvenation and Urban Transformation
BASA	Bangladesh Association for Social Advancement
BGD	Biogas Digester
BMGF	Bill and Melinda Gates Foundation
BORDA	Bremen Overseas Research and Development Association
CDD	Consortium for DEWATS Dissemination
CRTC	Composting Research and Training Centre
DPHE	Department of Public Health and Engineering (Bangladesh)
DVI	Delvic Sanitation Initiatives
Eawag	Swiss Federal Institute of Aquatic Science and Technology
ENPHO	Environment and Public Health Organization
ERAS	Environmental Resource Advancement Services
FSM	Faecal Sludge Management
FSTP	Faecal Sludge Treatment Plant
HFCB-K	Help for Children's Beilngries-Kathmandu
HFCW	Horizontal Flow Constructed Wetland
IFAD	International Fund for Agricultural Development
KUET	Khulna University of Engineering & Technology
LWSC	Lusaka Water and Sewerage Company
NWSC	National Water and Sewerage Corporation
O&M	Operation and Maintenance
ONAS	Office National d'Assainissement du Sénégal
ONEA	Office National de l'Eau et de l'Assainissement
OWSSB	Odisha Water Supply and Sewerage Board
PAB	Practical Action Bangladesh
PDB	Planted Drying Bed
PP	Polishing Pond
PPP	Public Private Partnership
Q&Q	Quantities and Qualities
SA	South Asia
Sandec	Sanitation, Water and Solid Waste for Development
SDC	Society Development Committee
SHT	Sludge Holding Tank
SNV	SNV Netherlands Development Organisation
SSA	Sub-Saharan Africa
STT	Settling Thickening Tank
TWAD	Tamil Nadu Water Supply and Drainage Board
UDB	Unplanted Drying Bed
UNESCAP	United Nations Economic and Social Commission for Asia and the Pacific
UNZA	University of Zambia
WAB	Water Aid Bangladesh
WASH	Water Sanitation and Hygiene
WSP	Waste Stabilization Pond

Background

Worldwide over the last years, a shift has taken place in the acceptance of faecal sludge management (FSM). It is now considered by many to be a viable solution alongside sewer-based systems in achieving citywide inclusive sanitation, and faecal sludge treatment plants (FSTPs) are starting to be constructed throughout Asia and Africa. For example, more than 40 FSTPs started operation in India and Bangladesh in the last four years, more than 30 are under construction in Uganda, and more than 400 will be constructed in India the next two years. This scaling up is urgently needed, as every year tons of faecal sludge are discharged directly into the environment. However, there is a lack of adequately functioning FSTPs, and a lack of information on operating FSTPs, upon which to base this scaling up. Inadequate designs will lead to the failure of many future FSTPs. Hence, there is a desperate need to learn from the failures and successes of existing FSTPs, so that future designs and scaling up can be sustainably.

Identified Challenges and Reasons for Failures:

Based on project expertise and the results of the scoping study, the main challenges for FSTP failures are:

- **Institutional recognition:** In general, institutional frameworks for the regulation of FSM are not well established. For FSM to be a success, governments need to acknowledge the need.
- **Quantities and Qualities (Q&Q) of faecal sludge:** Q&Q of faecal sludge are highly variable, which greatly complicates operation. Financial and technical resources for analytical methods are lacking, but they are necessary to design treatment plants for operation, and to monitor treatment performance. New methods and approaches need to be developed to address this gap. Eawag has recently developed and field-tested methods to address this gap (Strande et al. in preparation and Bousek, Skodak et al. 2018)
- **Capacity for operation:** O&M is one of the most common reasons for failure of FSTPs, and financial resources for FSM are lacking. Due to the rapid growth and implementation of management and treatment solutions, there is a lack of trained design, operation, and management capacity. Many planned FSTPs will be located in small towns or peri-urban areas. Therefore, they will require the development of stand-alone, relatively easy to implement, adaptive operating and management guidelines.
- **Design for operation:** There is little to no information available on the actual operation of FSTPs. Hence, there is no way to learn from existing experience to improve future design and operation. Currently, designs are based on estimated average values, even though faecal sludge does not follow a normal distribution, meaning the design assumptions are not valid during operation. The result is treatment technologies that are not loaded correctly, which leads to poor treatment performance and/or failure. There is an urgent need to figure out how to design FSTPs for the reality of actual operating conditions, so they can be operated effectively under real-life conditions.
- **Communication:** Coordination and communication between the stakeholders throughout the entire FSM service chain remains a challenge. Pathways of communication for active South – South sharing of knowledge need to be strengthened.

Project Objectives

FSM is now at a turning point with rapid scaling-up, but there are still many barriers to success to overcome. At this transition point, it is imperative to learn from existing FSTPs, in order to solve these hurdles for the design and operation of future FSTPs. The scoping study was designed to identify current gaps, evaluate the actual operating condition of existing FSTPs in comparison to design assumption, and to lay the foundation for what next steps should be taken.

Scoping Study: FSTPs in SA and SSA

Eawag / Sandec October 2019

Scoping Study

Methodology

To determine how to best utilize existing knowledge, a landscaping study was conducted to identify existing FSTPs in South Asia (SA) and Sub-Saharan Africa (SSA). As summarized in Table 1, the results included 120+ FSTPs in 13 countries throughout SA and SSA (complete results available in supplemental information). Basic information was not readily available and proved to be challenging to obtain, even through existing networks and partnerships. This confirmed that the only way to obtain accurate data is field visits directly to FSTPs. This was further confirmed during field visits, as the obtained information was frequently also not accurate.

Depending on availability, the following information was compiled:

- Treatment plant location (country, state, city, name of plant)
- Date of commissioning (year, month)
- SFD available (yes/no)
- Design capacity (m³/d, people equivalent)
- Operational status, capacity and frequency (operational/non-operation, m³/d, trucks/week)
- All treatment technologies in the treatment chain (including solid and liquid streams)
- Existing resource recovery (for both solids and liquids)
- Location of effluent discharge
- Interest in project collaboration (yes/no, contact details)
- Laboratory capacity (yes/no)
- Monitoring taking place (yes/no)

From the identified 120+ FSTPs, 23 in eight countries were selected for field visits to gather detailed information on the existing conditions and actual operation, and to evaluate the engagement of local project partners for the future in-depth monitoring of FSTPs and capacity development for operation. Summary information of the 20 most relevant FSTPs are presented in the section titled "FSTP Factsheets", and the 23 full field visit reports are available in the supplemental information.

The selection for field visits was based on:

- the FSTP should be operational by December 2018;
- the FSTP had to be relatively accessible;
- potential project partners expressed interest in collaboration;
- and the project team did not already have extensive knowledge of the FSTP.

Country	Total FSTPs	Operational	Operating since	Future planned	Range of design capacity [m ³ /d]	Drying beds	Mechanical Dewatering
SOUTH ASIA							
Bangladesh	15	7	2014-2017	1	2 - 180	15	0
Bhutan	1	1	2017	0	3	1	0
India	37	30	2015-2018	7	1 - 100	26	11
Nepal	4	2	2015-2017	2	1 - 27	4	0
WEST AFRICA							
Burkina Faso	4	4	2014-2016	1	125 - 250	4	0
Ghana	6	5	2002-2016	1	450 - 800	1	2
Ivory Coast	1	1	2017	0	100	1	0
Senegal	10	10	2006-2017	0	60 - 400	10	0
EAST AFRICA							
Malawi	3	0	-	3	10 - 50	3	0
Rwanda	1	1	2015	0	100	0	1
Uganda	35	2	2014	33	1 - 400	2	0
Tanzania	4	3	2012-2018	1	4 - 10	3	0
Zambia	2	2	2013-2014	0	3	2	0

Table 1 Summary of the landscaping study results in SA and SSA

Analysis of Results

Analysis of the results from the landscaping study and field visits identified different patterns of development of FSM throughout SA and SSA, and a more precise understanding of the overall challenges that need to be addressed.

South Asia: challenges

In India, Bangladesh and Nepal, acknowledgement of the importance of FSM has rapidly increased in the last five years, which led to the construction of many new FSTPs. They are located in cities and towns of all sizes, from small, semi-urban municipalities serving a population of tens of thousands, to big urban centres with millions of inhabitants. The identified FSTPs are mostly small- to medium-sized (treating from 1 to 75 m³ of faecal sludge per day) and are often operating under capacity. A wide range of public, private, public-private partnerships (PPPs), and non-governmental organizations (NGOs) are involved in the design, implementation, and/or operation. The main challenges identified are difficulties in delivering faecal sludge to the FSTPs, the high variability of Q&Q of faecal sludge, and the lack of capacity for adaptive management and operation.

Due to recent development of FSM in SA, many FSTPs are currently operating under design capacity, and are struggling to get sludge delivered to the FSTPs (e.g. Bhubaneswar, Faridpur, Khulna, Devanahalli, Kushtia and Gulariya). This leads to operational problems such as plants in planted drying beds dying off due to inadequate feeding, and inadequate loading of drying beds by operators. For unplanted drying beds, subsequently loading the same drying bed over several days, as opposed to batch operation, leads to clogging of drying beds and ponding of liquid on the surface. Observed examples include:

- overloaded drying beds in an attempt to have thicker layers of dried sludge to ease the removal of sludge from drying beds, leading to clogging and lower performance of the drying beds (e.g. Faridpur);
- uncontrolled discharges of sludge onto drying beds leading to full clogging and failure of drying beds (e.g. Gulariya)
- and loading beds based on design volumes (per bed) which are not actually occurring, meaning the same bed is loaded over several days (e.g. Karunguzhi, Jhenaidah), leading to clogging and reduced treatment performance.

Reasons identified for the FSTPs operating under capacity include a lack of FSM regulatory framework and/or enforcement, illegal dumping, and a lack of emptying by households. Other reasons include that many containment technologies have been constructed recently and are not yet full, or other sites closer to the city where the emptiers illegally dump the collected sludge. Examples of good and controlled management of the emptying and transport services were observed in Karunguzhi and Jhenaidah.

Problems with operation were often linked to the highly variable Q&Q of incoming sludge, which were not covered by the design assumptions, and operators had no recommendations on how to cope with this situation. For example, several days could pass with no sludge discharge, followed by one day with loadings greater than the design capacity. Operators frequently did not have the capacity to know how to best deal with these unplanned operating conditions. Quantities of incoming faecal sludge were evaluated with logbooks if they were accurately maintained, however, information was not available on the variability of incoming qualities of sludge and treatment performance. This highlights the need for rapid, low-cost methods, so operation can be adapted to actual operating conditions. The only visited FSTPs that analyse incoming sludge were Bhubaneswar (only twice per month) and Devanahalli FSTPs.

Sub-Saharan Africa: challenges

The identified challenges were more regionally diverse throughout SSA than in SA, and are presented here by regional trends.

Senegal, Burkina Faso

In Senegal and Burkina Faso the need for FSM started to be acknowledged and institutionalized earlier than SA over the last ten years. Information was more readily available for FSTPs located in the capitals or in larger cities, and that are under the responsibility of the national sanitation utilities. They have larger treatment capacities (60 to 150 m³/d), and are frequently overloaded, operating over design capacity. In Dakar and Ouagadougou, the FSTPs are receiving six to eight times the designed loading every day. Dakar is unique, in that the FSTPs are operated through a PPP, and run by a highly skilled team of professionals including PhDs on the topic of faecal sludge management (Delvic), and has also had long-term collaborations with Eawag and other research institutions. The result is that Delvic is researching ways to adapt FSTPs to manage the overloading in a controlled and studied way, demonstrating that solutions can be developed with an adequate level of interest, incentives and capacity. Whereas in Ouagadougou, operators struggle to treat the volumes of incoming sludge and have to routinely shut down the FSTPs, with obvious direct impacts on public and environmental health. The operators of two of the FSTPs continuously load the drying beds until they cannot receive more sludge, and become totally clogged. When the drying beds are all overflowing, the FSTPs have to close for several weeks to allow the sludge to dry so it can be removed and the drying beds can be cleaned. When the two FSTPs shut down, trucks discharge faecal sludge at the third FSTP, which significantly increases the loadings, and ultimately leads to the temporary shutdown of the third FSTP. The result is very poor treatment performance when the three FSTPs are "operating", to a total absence of treatment when the FSTPs shut down. In the long-term, the whole infrastructure will rapidly wear out and need to be replaced (e.g. filter media of the drying bed and the piping system).

Scoping Study: FSTPs in SA and SSA

Eawag / Sandec October 2019

Ivory Coast

In Ivory Coast, the national sanitation utility (ONAD) is currently testing an integrated FSM approach in the small northern town of Korhogo (fewer than 300'000 people in 2014) with the operation of one medium size (100 m³/d) FSTP. They plan to learn from this experience prior to scaling up in the rest of the country, and more FSTPs are already planned in Abidjan and other cities. The main challenges at the Korhogo FSTP is that the design assumptions did not take into account the absence of regionally available sand for the filter media, and the lack of onsite laboratory capacity. Due to the difficulties of finding sand in Korhogo, the top layer of the drying beds is composed instead of fine gravel. The result is rapid clogging of the beds, as the gravel is not fine enough to filter out adequate solids. Currently, the gravel is being cleaned in between each loading cycle, but this is labor intensive and will not be sustainable when operating capacity is reached. Because there is no laboratory capacity, any monitoring would require samples being shipped to Abidjan for analysis (> 550 kilometres). Another problem, is that collection and transport companies also transport industrial waste with their vacuum trucks, opening up many risks for industrial contamination, and inadequate protection of public and environmental health. Fortunately, a motivated engineer is responsible for the management and operation, and they are trying out options for improvement such as tiles on top of the drying bed, and inspection of incoming sludge. This case again highlights the current lack of design guidelines for actual operation, and the need for highly skilled operators to be able to deal with this gap.

Zambia, Malawi and Tanzania

In Zambia, Malawi and Tanzania, there are several FSTPs that were initiated by non-governmental organizations, and target small, densely populated, low-income areas, at the community scale (three to eight m³/day). In addition, existing wastewater treatment plants are often used for faecal sludge discharge and in some cases are being refurbished to be used only as FSTPs. The main issues observed were FSTPs operating over capacity, lack of clearly dedicated management and operating personnel at the FSTP, and operator capacity. In general, the wastewater treatment plants were only partially- to non-operational.

In Lusaka, Zambia, teams of manual emptiers are operating the two FSTPs (Chazanga and Kanyama) that are run by water trusts under LWSC. However, the emptiers do not have adequate capacity for adaptive management of daily operation. For example, they do not like to use the grit chamber because they find it a hassle, but the result is that the anaerobic digester becomes clogged, resulting in a one month shut-down every three months while the piping and digester are manually cleared out. This highlights the need for skilled staff at the treatment plant level, and adequate guidelines for adaptive operation and management of FSTPs. In addition, Kanyama did not have operating drying beds at the time of the field visit, they were shut down due to concerns with contaminating ground water during a cholera outbreak. New drying beds will be conducted, however, they are located off-site which will require trucking of dewatered sludge to the drying beds.

In Blantyre, Malawi, the FSTPs were still under construction at the time of the field visit. They were since commissioned, but already the Limbe FSTP has had a structural failure with the collapse of a concrete tank that was not reinforced and is non-operational.

Uganda

The Lubigi FSTP has been operating in Kampala since 2014 (400 m³/d) and an FSM institutional regulatory framework is in place. Construction of Lubigi highlights the difficulties of determining Q&Q, as it was already at long-term design capacity within the first month, making overloading an issue. Even with the highly-skilled staff of Lubigi, and the high-quality of construction, they regularly experience operating challenges since as ponding and clogging of drying beds and pump failures. The National Water and Sewerage Corporation (NWSC) and the Ministry of Water and Environment are currently scaling up FSM throughout Uganda, with an ambitious countrywide plan for the construction of more than 30 FSTPs in small towns, and a second FSTP in Kampala. Information about the new, planned FSTPs was difficult to gather, and highlights the lack of communication and sharing of information between sector stakeholders.

The Way Forward

Currently, there are a handful of FSTPs with adequate financial resources, capacity, and monitoring for reasonably adequate operation, such as Devanahalli, Dakar and Bhubaneshwar. These FSTPs can serve as showcases, but will not be representative of the overall situation with rapid scaling-up. Hence, there is an urgent need to build on this existing knowledge, in order to generate guidelines for the more independent operation of planned FSTPs, which will have limited resources and capacity. Without updated design assumptions, appropriate monitoring plans, a better understanding of actual Q&Q of faecal sludge, capacity building, and enhanced dissemination and communication, the scaling-up will ultimately result in failures, and inadequate protection of public and environmental health. To address these gaps, there is a need for global in-depth monitoring and evaluation of existing FSTPs. The knowledge gained during the study could then be used for ongoing capacity development, and to generate updated guidelines and strategies for:

- **Institutional recognition:** improved institutional commitment to sustainable implementation and operation of FSM based on partner engagement.
- **Q&Q of faecal sludge:** affordable and easy to implement methods to predict Q&Q of faecal sludge.
- **Capacity for operation:** training materials and guidelines for adaptive management and operation of FSTPs.
- **Design for operation:** guidelines and recommendation for the design of FSTPs for actual operating conditions.
- **Communication:** pathways for South – South sharing of knowledge and information.

It is apparent, that to implement such an ambitious monitoring plan, and to have uptake during and after the project, it is crucial to directly engage with the institution that is responsible for operation and performance of each local FSTP. Due to the resulting number of partners, and geographical locations, regional project management units would be required. This would also help to ensure future uptake, communication, and capacity development. A central overall project coordinator would also be required, with responsibility for collaborative development of sampling plans, technical back-stopping during the entire data collection period, and finalizing improved guidelines.

Based on the results from the scoping study and regardless of the scale of such evaluation and monitoring projects (from the evaluation of a single FSTP to a worldwide project), the following activities and areas of action should be considered.

Selection of Project Partners

Institutions operating FSTPs are the most important partners. Without them, a project cannot go ahead, and will not have future uptake. Operating institutions should be actively engaged in the project, with the goal of improving operation and performance of their FSTP(s). Regional project manager should be a renowned research institution that have capacity in laboratory analysis. They should work closely with the operating institutions, and should work on the collaborative implementation of the monitoring and action plan.

Monitoring – Q&Q

At the start of in field monitoring, Q&Qs of faecal sludge should be evaluated to determine if the FSTPs were designed adequately for the area they are serving, and to determine the best, low-cost methods to determine loadings based on real-time fluctuations. This could be based on the approach developed by Eawag (Strande et al. in preparation). Based on the results, it should also be evaluated if overall modifications in operation should be made to adapt to current and future characteristics (loadings), and recommendations developed for design guidelines on sizing of FSTPs.

Monitoring – Treatment Performance

Where laboratory capacity and analytical machines are lacking, the FSFL (faecal sludge field laboratory) low-cost methods developed for in-field emergency settings could be evaluated (Bousek, Skodak et al. 2018) . This also provides a method for future scaling up of low-cost monitoring plans in small towns and peri-urban areas. Treatment performance should be tracked with time during the project to verify improvement of operation and performance based on recommendations during the project implementation.

TS and TSS are the most important parameters for loadings of drying beds, hence, they should be measured the most frequently. The moisture content throughout the drying cycle should also be monitored to understand drying times and operating performance. Other parameters such as nutrients, faecal contamination or final product quality can be measured depending on the requirements or relevance for a specific FSTP.

Monitoring of O&M

The results from the scoping study highlighted the lack of capacity at the FSTP level. O&M should be closely tracked to verify the actual uptake of recommended practices to improve performance and their effect on treatment performance. A monitoring guideline should be developed to evaluate ongoing management and identify potential problems to address. This should include an overall financial balance of operation. The results should also be used to compare operational expenditure (opex) and capital expenditure (capex) to other types of treatment technologies whenever relevant.

Scoping Study: FSTPs in SA and SSA

Eawag / Sandec October 2019

Continuous Optimization of Operation

As already introduced in the above activities, a special effort should be put on continuously optimizing the operation and treatment performance based on the ongoing results of the Q&Q study and monitoring of treatment performance and O&M activities. This should contribute to locally build O&M knowledge and expertise as well as provide data and knowledge for future guidelines on how to design FSTPs for operation and on adaptive operation and management of FSTPs on a more global level.

Regional FSM Sharing Workshops and Regional Dissemination Workshops

One of the key identified obstacles to scaling-up is the lack of capacity at the FSTP level, and the lack of available information and communication amongst stakeholders and FSTPs. Regional workshops with the relevant sector stakeholders to share existing experience and challenges as well as relevant findings and new guidelines are crucial. In addition to disseminate to the broadest audience possible gained knowledge, these workshops would also initiate, where it does not exist yet, a practitioners and institutions FSM network in the regions of the project as well as to develop the capacity of the relevant institutions.

FSTP Factsheets

The FSTP factsheets summarize important aspects of the FSTPs that were visited during the scoping study and the full field reports are available in the supplemental information. The factsheets are separated into four main parts:

1. The **Background** section provides basic information on the FSTP's location, funding, implementation, start of operation and designed capacity as well as on the sanitation infrastructure situation of the city. The treatment sequence is also presented supported by the FSTP flow diagram.
2. The **Management Scheme** section provides information about who currently owns and operates the FSTP and containment emptying and transport services. The financial flows and organizational and monitoring links for the FSM service chain are presented in a flow diagram.
3. The **Designed Versus Actual Operation** section illustrates with tables and diagrams the differences between the designed values and actual loading of the drying beds (see explanation below).
4. The **Challenges and Way Forward** section highlights the identified operational challenges and suggests a way forward to improve the long-term operation and treatment performance of the FSTP.

Diagram explanation

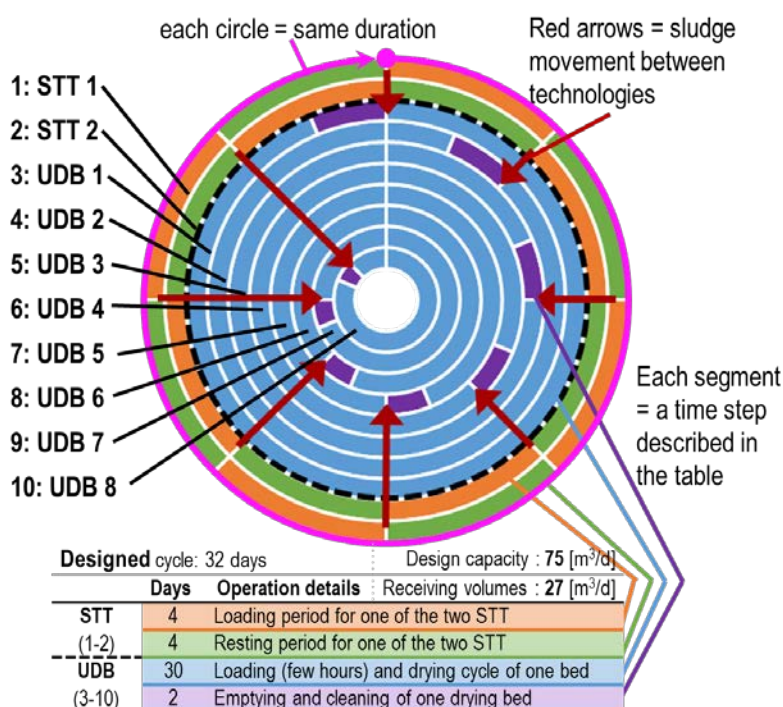

The diagram represents the **loading cycles** of the treatment plant. One loading cycle is defined as the process that occurs during the period of time when each of the beds have been loaded once and when the first bed loaded is ready to be loaded again.

Each circle is illustrating the estimation of what is happening (or what was designed to happen) at **one specific (type of) treatment technology unit** (e.g. one drying bed, a group of three drying beds or a settling-thickening tank) during the **loading cycles**.

The circles are divided in **segments** that represent the **different phases** (colours) of the cycle and their respective duration (length).

If untreated sludge is not discharged directly onto the drying beds, the **pre-treatment technology** (e.g. settling-thickening tank or anaerobic digester) is represented by the **outer circles**. The dotted line separates the two technologies. The dark red arrows describe the **transfer** of sludge from the pre-treatment technology to the drying beds.

The tables describe with words what is happening during the designed and the actual operating loading cycle.

Abbreviation

Please refer to page iv for abbreviations and acronyms.

Scoping Study: FSTPs in SA and SSA

Eawag / Sandec October 2019

Jhenaidah, Bangladesh

visited in December 2018

Background

Jhenaidah FSTP is located 5.5 [km] west from Jhenaidah city centre, in (coordinates: 23.548868, 89.121251). It was first constructed through a DPHE project in 2014 and then refurbished by SNV with funding from BMGF in 2016. The FSTP started operation January 2017 and was designed for a capacity of 36 [m³/d]. The municipality is fully relying on onsite sanitation and this is the only FSTP.

The treatment consists of five planted and three unplanted drying beds. The leachate is treated in two parallel horizontal flow constructed wetlands and the dried sludge is stored in a storage shed. The unplanted drying beds are not in use.

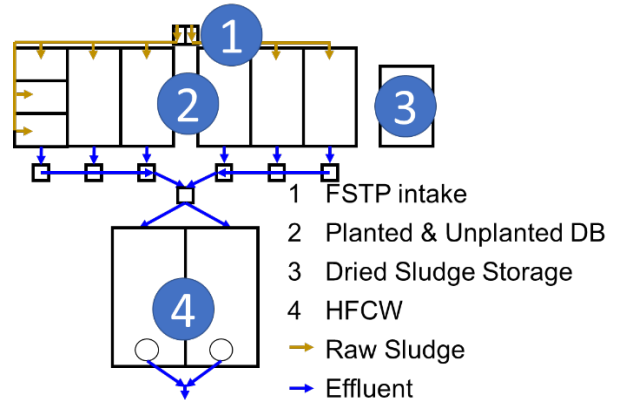

Management Scheme

The municipality owns the FSTP and two small vacutugs (1.5 and 2 m³). AID Foundation is operating and maintaining both assets through a PPP with the municipality. The households have to call the municipality for desludging services, which then inform AID foundation. The households pay fixed emptying fees directly to the vacutug drivers and AID foundation pays monthly lease fees to the municipality based on the number of containments emptied. The municipality is interested to develop co-composting activities at the treatment plant with municipal solid wastes.

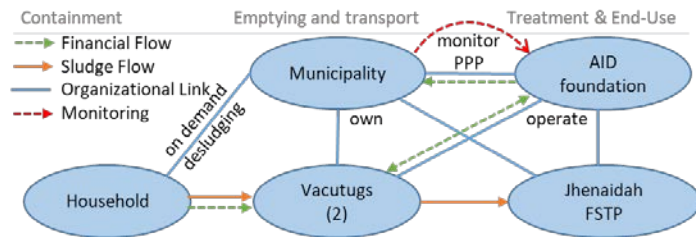

Designed Versus Actual Operation

Designed cycle: 2.5 to 3.5 days (one holiday/week)

Design capacity: 36 [m³/d]

Days	Operation details
0.5	Loading of two beds (5x8 [m]) with 0.4-0.5 [m] sludge per day (about 36 [m ³ /d]). One in the morning and one in the afternoon.
2-3	Drying cycle (two to three days drying cycles)

Design: 12 cycles: 36 days

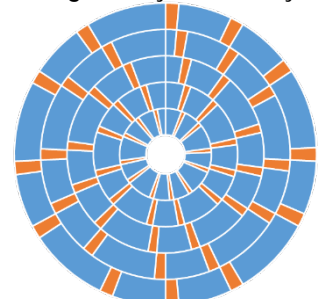

Operating cycle: 2 to 13 days

Receiving volumes: 0-22 [m³/d]

Days	Operation details
1-3	Loading of bed typically with 8 to 12 [m ³] of sludge during one, two or three days in a row
2-11	Drying cycle from two to 11 days depending on the amount of sludge coming, the judgement of the operator as well as operational and technical issues with the beds

Logbook records: 31 days

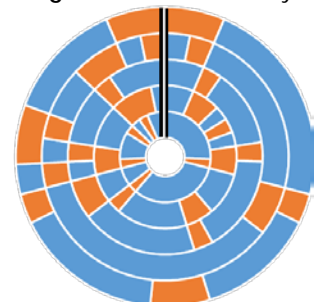

Challenges and Way Forward

Challenges faced by the FSTP include the small quantities of sludge being discharged, and the lack of capacity to deal with the high variability of Q&Q of faecal sludge. A significant amount of sludge at the municipality level is dumped directly in the environment, threatening public health. In addition, irregular loadings results in mortality of plants in planted drying beds. This is being mitigated by a swivel pipe in the leachate chambers. However, loading one bed several days in a row, decreases treatment performance, stresses the plants and increases the risk of clogging of the filter media and the drainage system. One drainage pipe already clogged and had to be replaced.

An SFD to understand where the sludge is leaving the FSM service chain is necessary to implement the best measures to increase the amount of sludge being delivered to the FSTP. This could also be increased by officially including manual emptiers in the service chain. Implementing close monitoring to optimize loading patterns will help ensure the sustainability of the FSTP.

FSTP in SA and SSA: a scoping study

Eawag / Sandec October 2019

Faridpur, Bangladesh

Background

visited in December 2018

Faridpur FSTP is located 3 [km] north from Faridpur municipality, (coordinates: 23.622391, 89.845455). It was funded by the Department For International Development (DFID) and designed and by Practical Action Bangladesh (PAB). The FSTP started operation in January 2017 and was designed for a capacity of 24 [m³/d]. It is the only sanitation treatment provider as the municipality is fully relying on onsite sanitation systems.

The treatment consists of 16 unplanted and 12 planted drying beds. The leachate is treated in six baffled tanks (three without and three with filtering media), a series of horizontal flow constructed wetlands and a maturation pond. The dried sludge in pre-processed (grinded) in the dried sludge storage shed and then transported off-site to a co-composting unit for further processing.

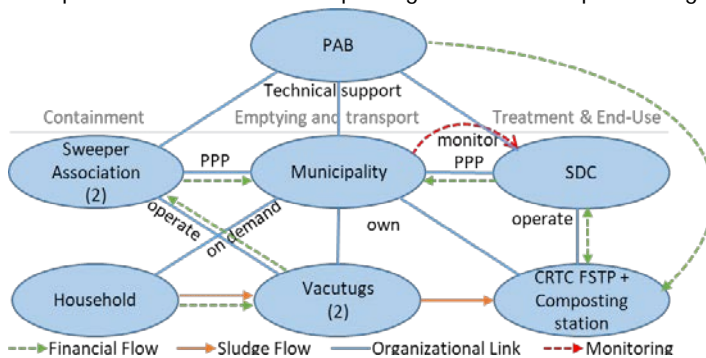
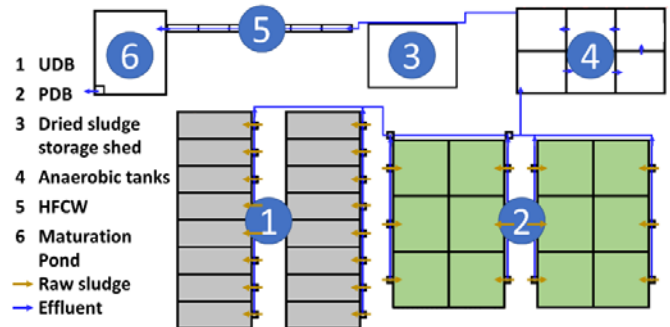

Management Scheme

The municipality, which owns the FSTP, has delegated its operation to the private company SDC through a PPP. PAB is providing technical support and financial support for maintenance of the FSTP.

The emptying and transport of sludge is done by two desludging trucks owned by the municipality but rented and operated by two sweeper associations. For desludging services, the households have to call the municipality which will then mobilize one of the two associations.

Designed Versus Actual Operation

Designed cycle: 18 (UDB) and 7 (PDB) days Design capacity: 24 [m³/d]

Days	Operation details
UDB 6 [m ³ /d]	1 Loading one bed (3x10 m) with 0.2 m sludge per day
	13 Drying cycle
	2 Emptying and cleaning of one bed per day
PDB 18 [m ³ /d]	1 Loading one bed (8x8 m) with 0.3 m sludge per day
	6 Drying cycle

Operating cycle: Receiving volumes: 0-4 [m³/d]

Days	Operation details
UDB 0 - 14 [m ³ /d]	7-21 Loading of one bed with approximately 42 m ³ of sludge. Typically during one to three weeks.
	12-17 Drying cycle
	2 Emptying and cleaning
	... Resting period
PDB: 0 [m ³ /d]	The PDB are not used regularly

Unplanted Drying Beds

Two cycles: 36 days

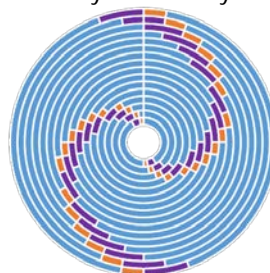

Planted Drying Beds

Five cycles: 35 days

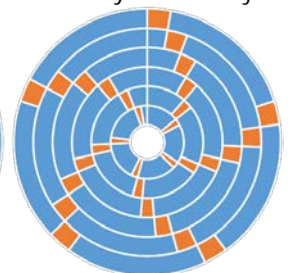

Logbook records: 64 days

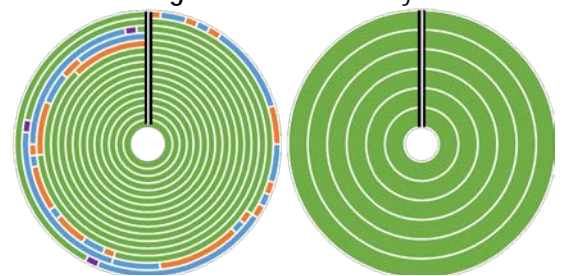

Challenges and Way Forward

Challenges faced by the FSTP include the small quantities of sludge being discharged, and the irregular loading of beds. A few of the drying beds are overloaded, and the rest are underutilized, as maximizing revenue is prioritized over the long-term sustainability of the infrastructure. The PDBs are rarely used, and half of the UDBs are loaded several times with all the incoming sludge. This will result in clogging of their filter media.

An SFD to understand where the sludge is leaving the FSM service chain is necessary to implement the best measures to increase the amount of sludge being delivered to the FSTP. Based on the current loading as well as on the requirements of the different stakeholders, a new optimized operation plan should be implemented that takes into account for dewatered sludge that is needed for the co-composting operations, as well as the long-term sustainable operation of both the UDBs and PDBs. Initially, each UDB should be loaded for a maximum of one day and 6 m³ as designed, but should be adaptive and closely monitored.

Scoping Study: FSTPs in SA and SSA

Eawag / Sandec October 2019

Sakhipur, Bangladesh

visited in December 2018

Background

Sakhipur FSTP and co-compost Plant is located in Tangail District, 3 [km] south-west from the town centre (coordinates: 24.3092118, 90.154212). It is the only FSTP in the District. It was designed by WAB and constructed by BASA with financial support from WAB and the Municipality. The FSTP started operation in January 2016 and was designed for a capacity of 8 [m³/d].

The treatment consists of 10 unplanted drying beds. Leachate is treated in settling tank, a constructed wetland and a polishing pond. The dried sludge is co-composted with organic waste in the co-composting plant located within the FSTP compound. The compost is packaged and sold in the local market.

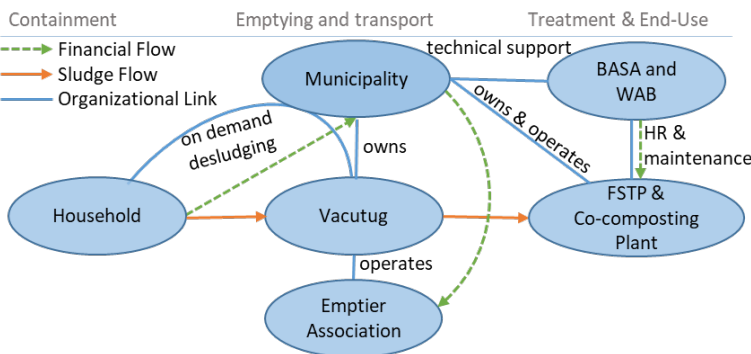
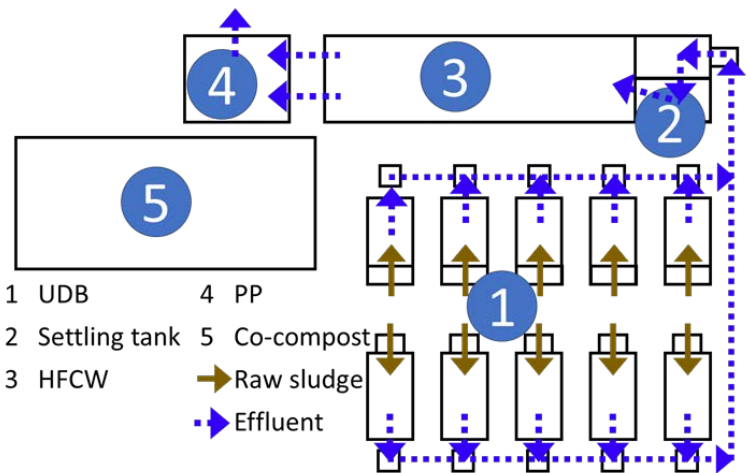

Management Scheme

The municipality owns the plant and one vacutug of 1 [m³]. It operates the plant with technical support from BASA and following the developed O&M guidelines. The municipality and WAB are sharing the HR and O&M costs.

Households submit an application and pay emptying fees at the municipality. The conservancy department is providing the emptying services. The radius of service provision is 3-4 km. Emptying service, by law, cannot be provided at night.

Designed Versus Actual Operation

Designed cycle: 14 days Design capacity: 8 [m³/d]

Days	Operation details
1	Loading one bed 4 [m ³] sludge per day
12	Drying cycle
1	Emptying and cleaning of one bed per day

Operating cycle: 15 to 17 days Receiving volumes: 0-8 [m³/d]

Days	Operation details
1	Loading one bed with typically with 2 to 5 [m ³]
13-15	Drying cycle
1	Emptying and cleaning
...	The bed is left empty until next load

Design: three cycles: 42 days

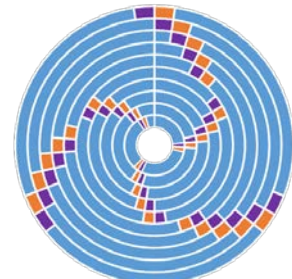

Logbook records: 37 days

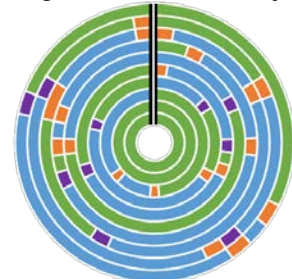

Challenges and Way Forward

The high variability of the Q&Q of incoming sludge is one of the major challenges for operation of the FSTP. Because of this variability, sludge application per bed varies and sometime exceeds designed volume, and the beds are inequally loaded. In addition, there is a lack of a clear business plan and limited human resources and capacity at the municipality level.

A strategy needs to be developed to ensure regular loading of sludge, with on-going adaptation based on learning from experience. A business plan, an optimized operation plan, and a monitoring plan need to be put in place.

Khulna, Bangladesh

Background

Khulna FSTP is located about 8 [km] west from the Khulna city centre (coordinates: 22.793750, 89.492111). The municipality is fully relying on onsite sanitation and this is the only FSTP. It was designed by KUET and AIT. It was constructed by the municipality with financial support from SNV and BMGF. The FSTP started operation in March 2017 and was designed for a capacity of 180 [m³/d].

The treatment consists in 6 planted and 6 unplanted (used only for experiments) drying beds. The leachate is treated in a horizontal flow constructed wetland, followed by a vertical flow constructed wetland. There is no resource recovery practice but the municipality is planning on making briquette with the dried sludge. The beds have not been emptied yet because of the low inflow of sludge to the FSTP.

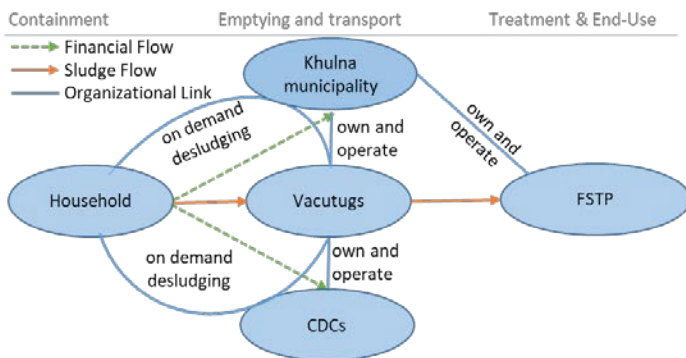
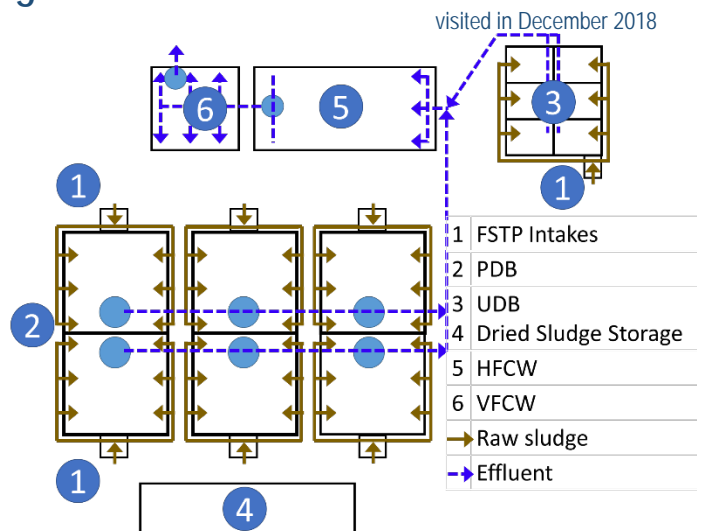

Management Scheme

The municipality owns, operates and maintains the FSTP through its Conservancy Department. The municipality is currently in the bidding process to outsource the operation of the FSTP. SNV is providing technical backstopping and financial support for the maintenance.

The emptying services are provided both by the municipality and three Community Development Committees (CDCs), which own 8 and 3 vacutugs respectively. The municipality has trained 250 emptiers who are hired and paid as required by the municipality. The CDCs operate independently but bring sludge to the FSTP.

Designed Versus Actual Operation

Designed cycle: 7 days (1 holiday/week)

Capacity: 180 [m³/d]

Days	Operation details
1	Loading of one beds (32 x 12 [m]) with 180 [m ³] sludge per day.
6	Drying cycle

Design: one cycles: 7 days



Operating

As per the logbook data, the average monthly inflow was 36 [m³] until August 2017. Sludge inflow increased up to 6 to 8 [m³/d] by the second half of 2018. Thus, the daily sludge inflow is insignificant for an FSTP that is designed for 180 [m³/d].

The data readily available was insufficient to create a cycle diagram

Challenges and Way Forward

A major challenge faced by the FSTP is the small quantities of sludge being discharged. The municipality and its agglomeration have over 1 million inhabitants, with only insignificant volumes of sludge being discharged at the FSTP, meaning most faecal sludge is dumped directly in the environment, threatening public health. There are also infrastructure issues, such as clogging of the distribution pipes.

An SFD to understand where the sludge is leaving the FSM service chain is necessary to implement the best measures to increase the amount of sludge being delivered to the FSTP. Close monitoring and education of emptiers, and officially including manual emptiers in the service chain, are necessary implementations. Solutions for infrastructure problems need to be implemented. A strategy needs to be developed to ensure regular loading of sludge, with on-going adaptation based on learning from experience.

Scoping Study: FSTPs in SA and SSA

Eawag / Sandec October 2019

Kushtia, Bangladesh

Background

Kushtia FSTP is located about 5 [km] west from the city centre (coordinates: 23.911983, 89.094932). This is the only sludge treatment facility in the city, which is fully relying on onsite sanitation. It was initially established as a composting plant in 2008 but was later extended as an FSTP in 2012. Waste Concern designed it and the local government, SNV and UNESCAP funded the construction. The FSTP started operation in 2012 and was designed for a capacity of 9 [m³/d]. The treatment consists of two sludge holding tanks followed by two unplanted drying bed. Each bed is divided into four compartments. The leachate is treated in two parallel semi-mechanised coco-peat filters and the dried sludge is co-composted with organic waste in the composting plant.

visited in December 2018

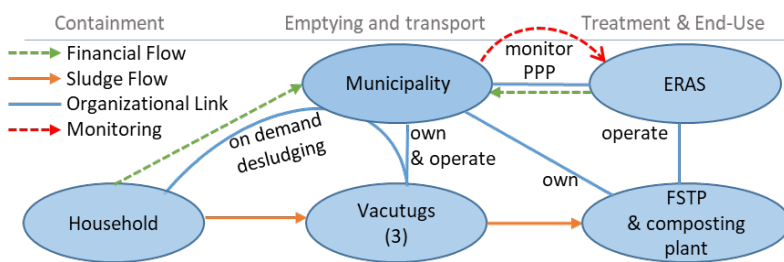
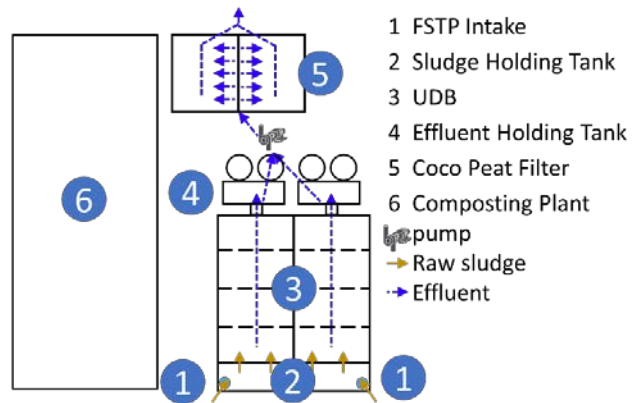

Management Scheme

The municipality owns the FSTP and three small vacutugs (1, 2 and 4 [m³]). The municipality has delegated its operation to ERAS.

The municipality is responsible for sludge collection and transportation to the FSTP but does not monitor where their trucks discharge or dump the collected sludge. The households pay fixed emptying fees to the municipality.

Designed Versus Actual Operation

Designed cycle: 25 to 36 days

Design capacity: 9 [m³/d]

Days	Operation details
SHT (1)	0.2-0.5 Several loading (1-4 [m ³] per load) per day
	0.2-2 Short settling (1-2 hours) after each load. The sluice gates are opened and the sludge flows to the UDBs (beds 1 to 4). The settled solids are emptied after a further drying of up to 2
	10-15 Resting period, while the other line of the treatment is used
UDB (2-5)	15-21 Loading period with several loading per day. The sludge flows until the last one.
	0.2-21 Drying cycle: In general, the sludge is shovelled out as soon as it can be. Bed 4 is emptied before each new loading; Bed 2 and 3 are emptied typically once or twice per week; Bed 1 is not emptied during loading period but after 15 to 21 days of drying when the alternate line is loaded.
	1 Emptying and cleaning
	0-15 Resting period, while the other line of treatment is used

Design: one cycle: 21-30 days

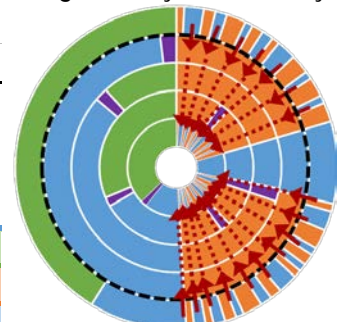

*To make it more readable, the above diagram represents only one line of treatment

The available information was insufficient to create an operating cycle diagram

Operating cycle: 7 to 25 days

Receiving volumes: 0-18 [m³/d]

The design and operating loading cycles are similar with the exception that receiving volumes are on average lower than design. However, the operator indicated that the FSTP could not take more sludge and is regularly refusing discharge to trucks coming at the FSTP.

Challenges and Way Forward

Although Kushtia has a higher emptying rate than other visited municipalities in Bangladesh, a major portion of the emptied sludge is being dumped directly into the environment. Main challenges include difficulties in enforcing legal discharge of sludge at the dedicated sites (i.e. the FSTP or two new trenches), and that there is not adequate capacity at the FSTP. The FSTP has a unique design, and is difficult to operate based on information from existing systems.

An SFD to understand where the sludge is leaving the FSM service chain is necessary to implement the best measures to increase the amount of sludge being delivered to the FSTP. Enforcement and education of the emptiers (municipal employees) is necessary. Options to increase the capacity of the current FSTP, the development of new treatment infrastructure and/or new safe discharge sites closer to the city are needed.

Sourgoubila, Burkina Faso

Background

Sourgoubila FSTP is located in the fast-growing Northwestern outskirts of Ouagadougou (coordinates: 12.42645; -1.68373). ONEA designed and supervised the construction of the FSTP, which was funded through a loan from IFAD and the world bank. The FSTP is one of three FSTPs. Ouagadougou relies almost entirely on onsite sanitation (less than 1% connected to sewers). The FSTP started operation in November 2016 and was designed for a capacity of 133 [m³/d].

The treatment process consists of 40 unplanted drying beds of 8x8 [m]. The leachate is treated in a series of anaerobic, facultative and maturation ponds whereas the dried sludge is stored on open ground.

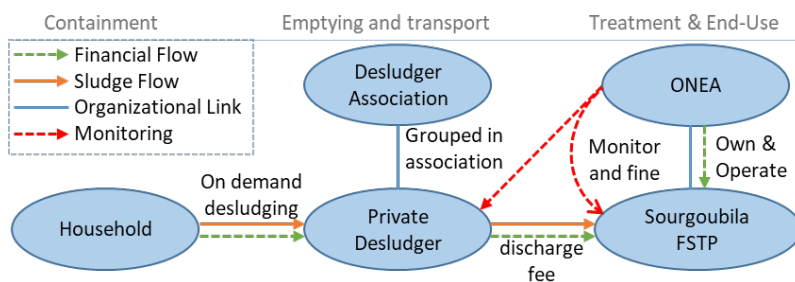
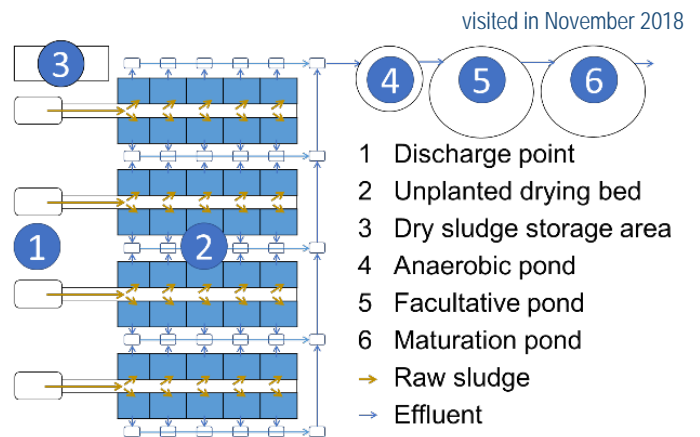

Management Scheme

ONEA owns and operates the FSTP. The private sector grouped in associations is fully handling the emptying and transport operations of the faecal sludge under the legal supervision of ONEA. Each truck has to pay a discharge fee at the FSTP (0.6 USD/m³).

Designed Versus Actual Operation

Designed cycle: 15 days Capacity: 133 [m³/d]

Days	Operation details
1	Loading of three beds (8x8 [m]) with 0.7 [m] sludge per day
13	Drying cycle
1	Emptying and cleaning

Operating cycle: 55 to 62 days Volume received: 100 [m³/d]

Days	Operation details
18-22	Daily full loading (0.9 [m]) of several beds with overnight settling
3	Resting period after the sludge does not settle overnight
1	Pumping of the supernatant to the anaerobic ponds
30	Drying cycle
2	Emptying and cleaning
1-4	The bed is left empty until next load

Design: four cycles: 60 days

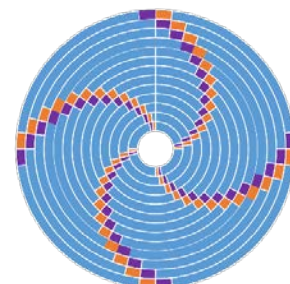

Operating: one cycle: 55-62 days

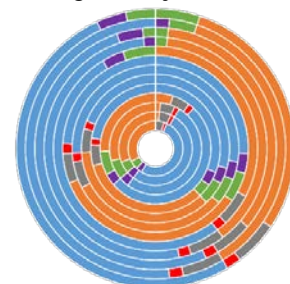

Challenges and Way Forward

One of the main challenges faced by the FSTP is the overloading of the drying beds. Daily loading of individual drying beds for three weeks in a row overloads the drying beds hydraulically and with solids. Hence, the beds clog quickly and the result is they are operated more as settling tanks than drying beds. This requires mechanical pumping of the liquid from of the beds when they become clogged. The result is decreased treatment performance and operating capacity, and operation in this fashion will lead to failure of the FSTP. The general overloading of all of the FSTPs in Ouagadougou lead to the regular shut down of all of the FSTPs. The result is that most of the faecal sludge is receiving to no treatment.

The operation of all three FSTPs in Ouagadougou need to be optimized for appropriate loading, with close monitoring during implementation. Optimization of treatment capacity (e.g. pre-treatment with settling-thickening tanks) and additional infrastructure are urgently needed.

Scoping Study: FSTPs in SA and SSA

Eawag / Sandec October 2019

Zagtouli, Burkina Faso

visited in November 2018

Background

Zagtouli FSTP is located 16 [km] northeast of Ouagadougou (coordinates: 12.313971, -1.643755). ONEA designed and supervised the construction of the FSTP, which was funded through a loan from IFAD and the world bank. The FSTP is one of three FSTPs in Ouagadougou, which relies quasi-entirely on onsite sanitation (less than 1% connected to sewers). The FSTP s in September 2014 and was designed to receive 125 [m³/d].

The treatment process consists of 48 unplanted drying beds of 16x8 [m]. The leachate is treated in a series of anaerobic, facultative and aerobic maturation ponds. The dried sludge is stored on open ground.

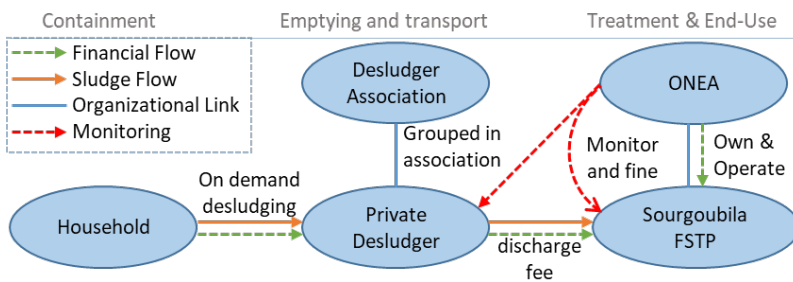
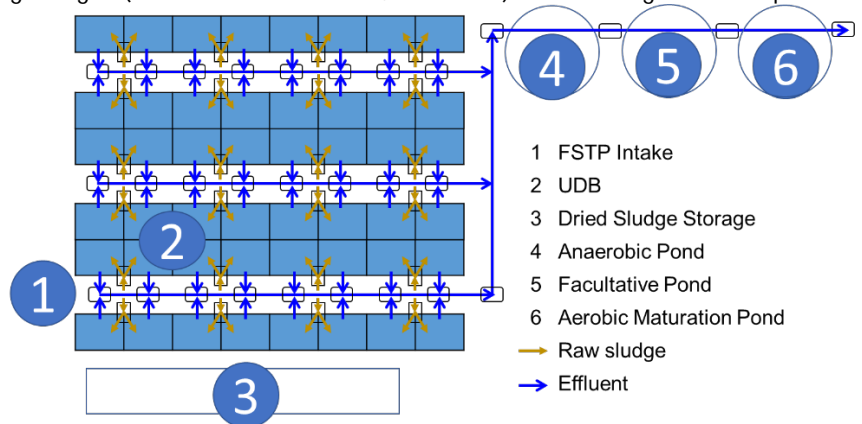

Management Scheme

ONEA owns and operates the FSTP. The private sector regrouped in associations is fully handling the emptying and transport operations of the faecal sludge under the legal supervision of ONEA. Each truck has to pay a discharge fee at the FSTP (0.6 USD/m³).

Designed Versus Actual Operation

Designed cycle: 32 days Designed capacity: 125 [m³/d]

Days	Operation details
4	Loading of six beds for four consecutive days at a rate of 2 discharges per bed per day (i.e. on average 20 [m ³ /d.bed])
27	Drying cycle
1	Emptying and cleaning

Operating cycle: 52 to 60 days Receiving volumes: 600-760 [m³/d]

Days	Operation details
18-22	Daily full loading (1 [m]) of several beds with overnight settling
3	Resting period after the sludge does not settle overnight
1	Pumping of the supernatant to the WWTP
30	Drying cycle
2	Emptying and cleaning

Once all the beds are overflowing, the FSTP shut down for one to two months

Challenges and Way Forward

One of the main challenges faced by the FSTP is the overloading of the FSTP and specifically the drying beds. Daily loading of individual drying beds for three weeks in a row overloads the drying beds hydraulically and with solids. Hence, the beds clog quickly and the result is they are operated more as settling tanks than drying beds. This requires mechanical pumping of the liquid from of the beds when they become clogged. The result is decreased treatment performance and operating capacity, and operation in this fashion will lead to failure of the FSTP. The general overloading of all of the FSTPs in Ouagadougou lead to the regular shut down of all of the FSTPs. The result is that most of the faecal sludge is receiving to no treatment.

The operation of all three FSTPs in Ouagadougou need to be optimized for appropriate loading, with close monitoring during implementation. Optimization of treatment capacity (e.g. pre-treatment with settling-thickening tanks) and additional infrastructure are urgently needed.

Design: two cycles: 64 days

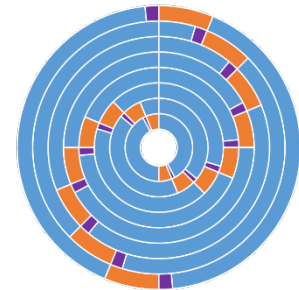

Operating: one cycle: 52-60 days

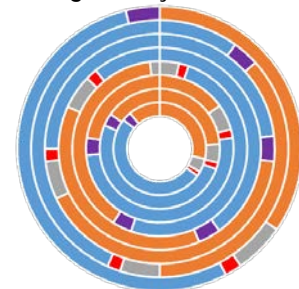

Kossodo, Burkina Faso

Background

Kossodo FSTP is located in an industrial area of Ouagadougou, Burkina Faso, 9 [km] from the city centre (coordinates: 12.4275536, -1.4817740). ONEA designed and supervised the construction of the FSTP, which was funded through a loan from IFAD and the world bank. The FSTP is one of three FSTPs in Ouagadougou, which relies quasi-entirely on onsite sanitation (less than 1% connected to sewers). The FSTP started operation in November 2014 and was designed to receive 125 [m³/d].

The treatment process consists of 48 unplanted drying beds of 16x8 [m] arranged in six rows of eight beds. The leachate is treated in the neighbouring WWTP.

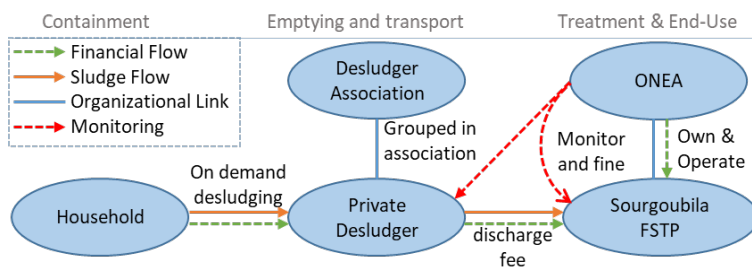
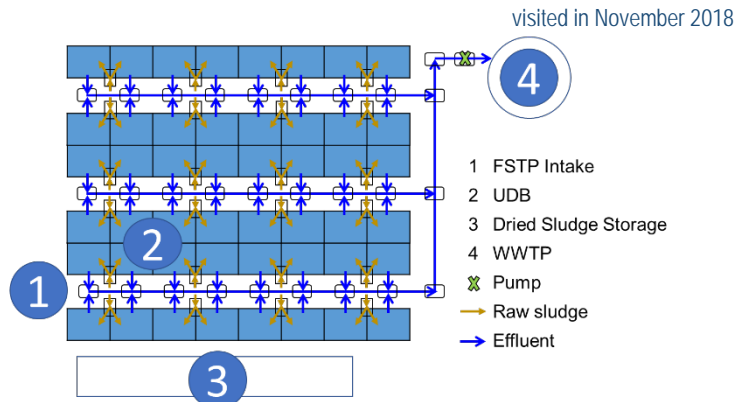

Management Scheme

ONEA owns and operate the FSTP. The private sector regrouped in associations is fully handling the emptying and transport operations of the faecal sludge under the legal supervision of ONEA. Each truck has to pay a discharge fee at the FSTP (0.6 USD/m³).

Designed Versus Actual Operation

Designed cycle: 32 days

Designed capacity: 125 [m³/d]

Days	Operation details
4	Loading of six beds for four consecutive days at a rate of 2 discharges per bed per day (i.e. on average 20 [m ³ /d.bed])
27	Drying cycle
1	Emptying and cleaning

Operating cycle: 52 to 60 days

Receiving volumes 600-760 [m³/d]

Days	Operation details
18-22	Daily full loading of several beds with overnight settling (8x16x0.9[m])
3	Resting period after the sludge does not settle overnight
1	Pumping of the supernatant to the WWTP
30	Drying cycle
2	Emptying and cleaning

Designed: two cycles: 64 days

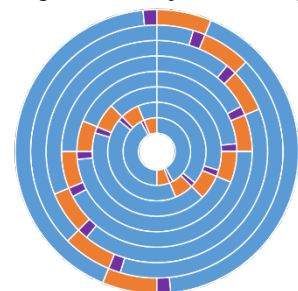

Operating: one cycle: 52-60 [days]

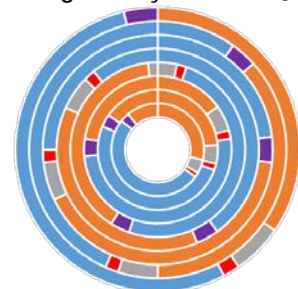

Challenges and Way Forward

One of the main challenges faced by the FSTP is the overloading of the FSTP and specifically the drying beds. Daily loading of individual drying beds for three weeks in a row overloads the drying beds hydraulically and with solids. Hence, the beds clog quickly and the result is they are operated more as settling tanks than drying beds. This requires mechanical pumping of the liquid from of the beds when they become clogged. The result is decreased treatment performance and operating capacity, and operation in this fashion will lead to failure of the FSTP. The general overloading of all of the FSTPs in Ouagadougou lead to the regular shut down of all of the FSTPs. The result is that most of the faecal sludge is receiving to no treatment.

The operation of all three FSTPs in Ouagadougou need to be optimized for appropriate loading, with close monitoring during implementation. Optimization of treatment capacity (e.g. pre-treatment with settling-thickening tanks) and additional infrastructure are urgently needed.

Scoping Study: FSTPs in SA and SSA

Eawag / Sandec October 2019

Bhubaneshwar, India

Background

visited in November 2018

Bhubaneshwar FSTP is located in the South-eastern part of the Odisha state capital city Bhubaneshwar (coordinates: 20.234687, 85.856658). The AMRUT scheme funded the project and OWSSB designed it and supervised the construction. The FSTP started operation in June 2018 and was designed for a capacity of 75 [m³/d] with the possibility to increase it up to 150 [m³/d]. It is the first and only FSTP of the city, which mainly relies on onsite sanitation systems. However, its sewer network is currently expanding.

The treatment consists of two settling-thickening tanks and eight unplanted drying beds. The leachate is treated in two parallel series of anaerobic baffle reactors, anaerobic filters, horizontal flow constructed wetlands and slow sand filters. The effluent is stored in a polishing pump equipped with an aeration pump. The dried sludge is stored in a storage shed.

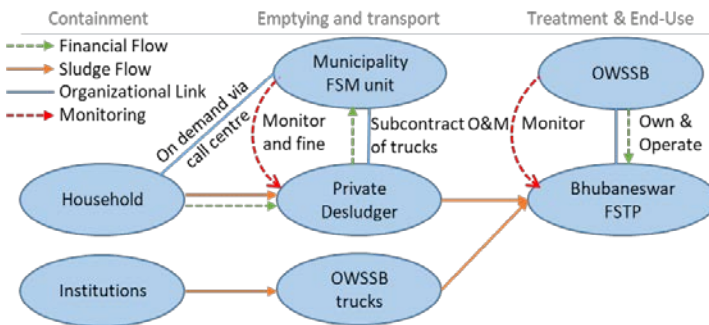
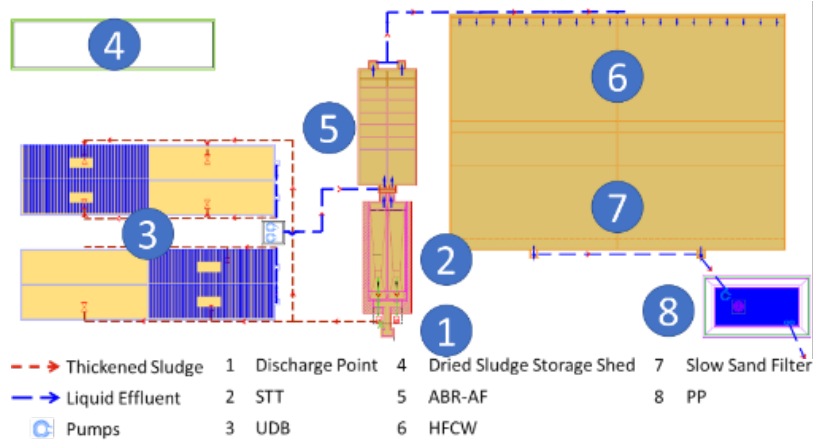

Management Scheme

OWSSB owns and operates the FSTP. The operation is fully financed by OWSSB and the FSTP does not charge any discharging fees. The desludging activities are the responsibility of the Bhubaneshwar municipality, which is the process of subcontracting the O&M of four 3m³ desludging trucks to private players. They are also putting in place a call centre to centralize the desludging demands from the households. OWSSB owns four 3m³ desludging trucks stationed at the FSTP, which are desludging free of costs the septic tanks from institutions in the city.

Designed Versus Actual Operation (operated as designed)

Design and Operating cycle: 32 days

Designed and Operating cycle: 32 days		Designed capacity: 75 [m ³ /d]
Days	Operation details	Receiving volumes: 27 [m ³ /d]
STT (1-2)	4 Loading period for one of the two STT	
	4 Settling period for one of the two STT	
UDB (3-10)	30 Loading (few hours) and drying cycle of one drying bed	
	2 Emptying and cleaning of one drying bed	

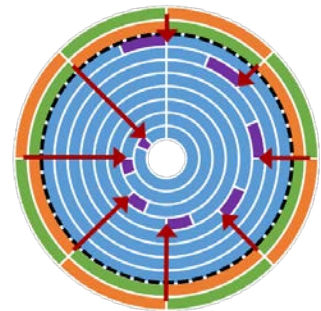

Challenges and Way Forward

One of the main challenges faced by the FSTP is getting sludge to be delivered to the FSTP. It is operating at less than half its designed capacity, with the biggest source of sludge being from large, institutional septic tanks that are deslugged at no cost by OWSSB trucks. The majority of household level sludge is dumped directly into the environment, with the majority of private and municipal trucks not coming to the FSTP. An FSM institutional framework is not yet in place. The settling tank has to be emptied by pump once a week, if it is left longer, the thickened sludge clogs the pump and the tank has to be emptied with desludging trucks.

An SFD to understand where the sludge is leaving the FSM service chain is necessary to implement the best measures to increase the amount of sludge being delivered to the FSTP. To ensure that faecal sludge is delivered to the FSTP will require a legal and regulatory framework, and strong communication between the municipality, OWSSB and the private desludging service providers.

FSTP in SA and SSA: a scoping study

Eawag / Sandec October 2019

Karunguzhi, India

Background

visited in November 2018

Karunguzhi FSTP is located in between the two Urban Local Bodies (ULB) it serves, Karunguzhi and Madurantakam, 80 kilometres south from Chennai, in Tamil Nadu (coordinates: 12.524571, 79.902245). The Directorate of Town Panchayats (DTP) funded the FSTP, the TWAD board supervised the design and construction and the municipality of Karunguzhi provided the land. The FSTP started operation May 10 2017, was designed for a capacity of 24 [m³/d]. The two municipalities are fully relying on onsite sanitation and this is the only FSTP.

The treatment process consists of 20 unplanted drying beds, each 6.2x8 [m]. The leachate is treated in a horizontal flow constructed wetland followed by a maturation pond whereas the dried sludge is stored in a storage shed.

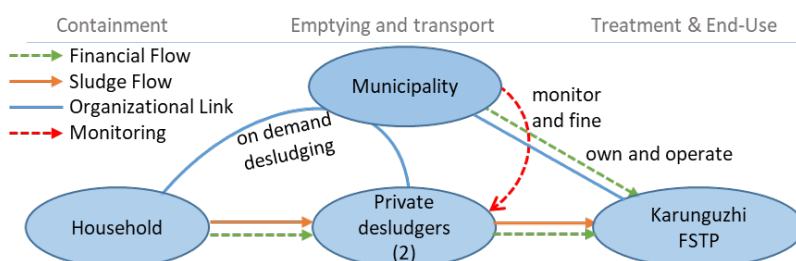
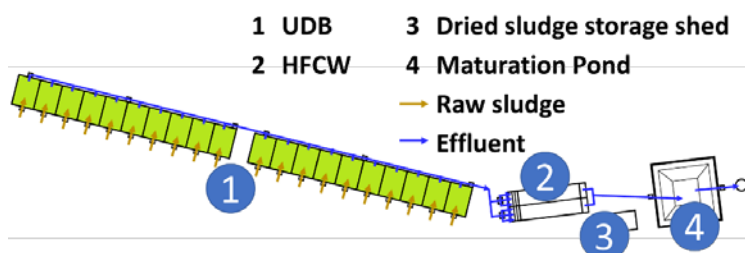

Management Scheme

The municipality of Karunguzhi owns and operates the FSTP (since February 2018).

For desludging, the households have to register at the municipality, which then assign the task to one of the two private entrepreneurs. A token system is in place at the municipality and at the FSTP to ensure the trucks empty their sludge at the FSTP. The truck pays a discharge fee of Rs. 100 per load.

Design Versus Actual Operation

Designed cycle: 23 days

Designed capacity: 24 [m³/d]

Days	Operation details
1	Loading of one bed (6x8.2 [m]) with 0.5 [m] sludge per day
21	Drying cycle
2	Emptying and cleaning of one bed per day

Operating cycle: 41 to 46 days

Receiving volumes: 3-26 [m³/d]

Days	Operation details
2-3	Loading of one bed with approximately 23 [m ³] of sludge during typically two to three days.
20	Drying cycle
2	Emptying and cleaning
17-22	The bed is left empty until next load

Two cycles: 47 days

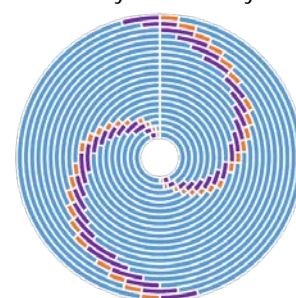

One cycle: 41-46 days

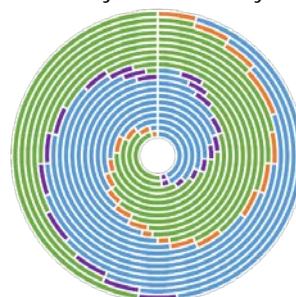

Challenges and Way Forward

The FSTP is usually underloaded, but has a challenge dealing with the high variability of the Q&Q of incoming sludge. Because of this variability, sludge application per bed varies and sometime beds are loaded over several days to reach the designed capacity of the bed. This leads to decrease in treatment efficiency and can result in clogging.

An SFD to understand where the sludge is leaving the FSM service chain is necessary to implement the best measures to increase the amount of sludge being delivered to the FSTP. Implementing close monitoring to optimize loading patterns will help ensure the sustainability of the FSTP.

Scoping Study: FSTPs in SA and SSA

Eawag / Sandec October 2019

Devanahalli, India

Background

Devanahalli FSTP is located west of Devanahalli municipality, 35 [km] north of Bengaluru, (coordinates 13.253093, 77.707223). It is the only faecal sludge treatment plant and the municipality is fully relying on onsite sanitation systems. It was funded by BMGF and designed and constructed by CDD society with the technical support of BORDA. The FSTP started operation in 2015 and was designed for a capacity of 6 [m³/d].

The treatment consists of two feeding tanks as a first dewatering step, followed by two parallel treatment lines for the settled sludge treatment: one composed of one bio-digester and stabilization tank and the second composed of one bigger stabilization tank. The stabilized sludge from both stabilization tanks flows to unplanted drying beds. The effluent from the feeding tanks and stabilization tanks flow to an anaerobic baffle reactor, anaerobic filter and horizontal flow constructed wetland. The final effluent and leachate infiltrate into the soakaway pit. The dried sludge is co-composed with municipal solid waste.

based on information provided by CDD society

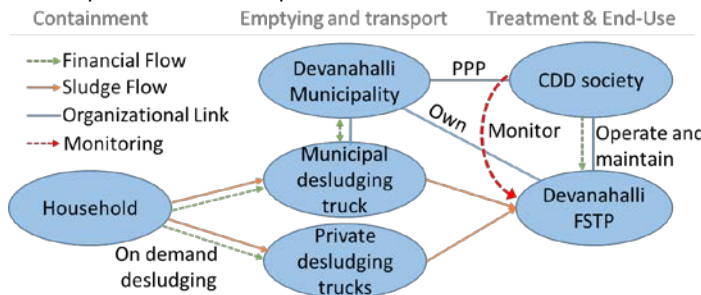
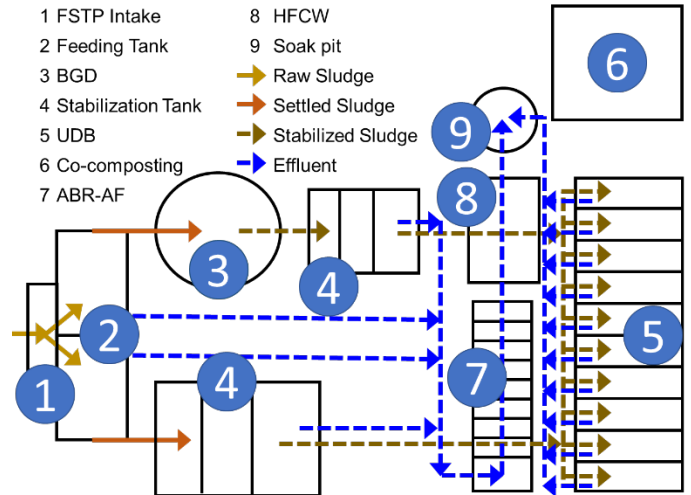

Management Scheme

Devanahalli municipality owns the FSTP and has delegated its operation to CDD society. CDD invests in upgrading the FSTP infrastructure, and monitors, and optimizes the performance.

Desludging services are based on demand with presence of municipal and private desludging trucks. It is challenging to make the private trucks discharge at the FSTP and most of the sludge discharged at the FSTP comes from municipal trucks.

Designed Versus Actual Operation

Designed cycle: 28 days		Designed capacity: 6 [m ³ /d]
Days	Operation details	
FT-BGD-ST (1)	2	Stabilization and settling period with several loads per day
	1	Every second day loading of one UDB (5-6 [m ³])
UDB (2-11)	18	Drying cycle
	1	Emptying and cleaning

Operating cycle: 21 to 45 days		Receiving volumes: 0-4 [m ³ /d]
Days	Operation details	
FT-BGD-ST (1)	3-4	Stabilization and settling period with several days without any loading and some days with some
	1	Every three to four days loading of one UDB (2.5-5 [m ³])
UDB (2-11)	15-28	Drying cycle
	1	Emptying and cleaning
	0-16	Resting period

Design: one cycle: 28 days

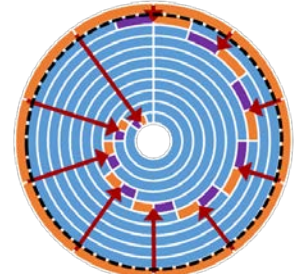

Operating: one cycle: 21-45 days

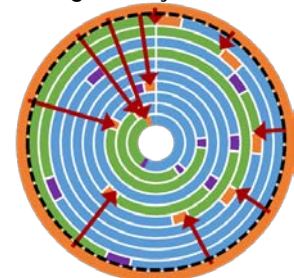

Challenges and Way Forward

A major challenge faced by the FSTP are the small quantities of sludge being discharged. A significant amount of sludge at the municipality level is dumped directly in the environment, threatening public health. Additionally, the FSTP had to go through major refurbishments (full cover of UDB and replacement of one biodigester and stabilization tank by one bigger stabilization tank) due to challenges not foreseen during design and implementation (i.e. odors, social acceptance and unstable soil). CDD has researched, funded and implemented solutions.

An SFD to understand where the sludge is leaving the FSM service chain is necessary to implement the best measures to increase the amount of sludge being delivered to the FSTP. To ensure that faecal sludge is delivered to the FSTP will require a legal and regulatory framework, and strong communication between the municipality, CDD and the private desludging service providers.

FSTP in SA and SSA: a scoping study

Eawag / Sandec October 2019

Puri, India

visited in November 2018

Background

Puri FSTP is located within the Puri wastewater treatment plant, about 3 [km] from the city centre, (coordinates 19.812717, 85.797620). The sewer network covers approximately 40 to 50% of Puri territory (CDD, 2017); the rest is covered by onsite sanitation. The AMRUT scheme funded the FSTP and OWSSB designed it and supervised the construction. The FSTP started operation in 2017 and was designed for a capacity of 50 [m³/d].

The treatment consists of one FSTP intake and four parallel settling-thickening tanks. The thickened sludge is then treated in two of the unplanted drying beds of the wastewater treatment plant. The effluent from the settling-thickening tanks and the leachate from the unplanted drying beds is pumped to the wastewater treatment plant inlet (capacity 15'000 [m³/d]). The dried sludge is used within the compound for gardening purposes.

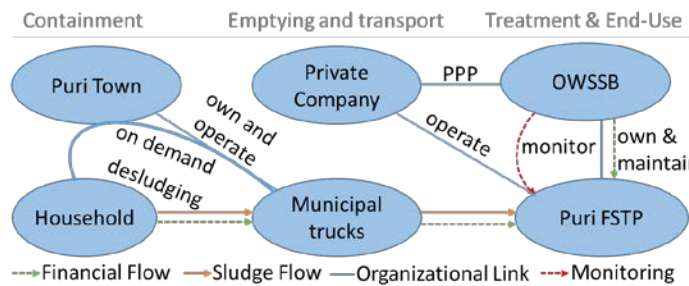
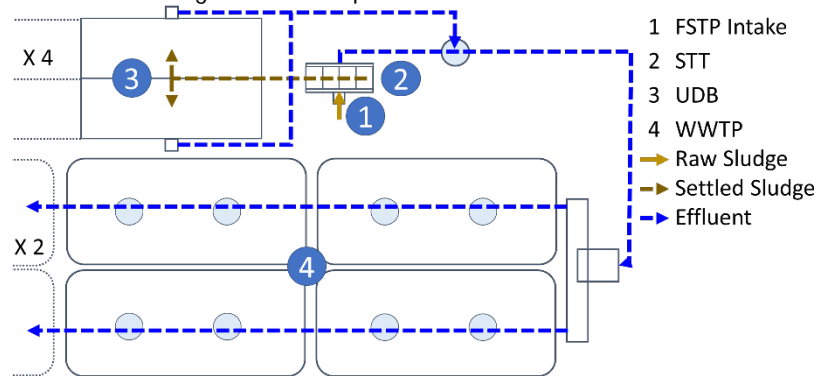

Management Scheme

OWSSB owns the FSTP and the wastewater treatment plant and has delegated their daily operation to a private company. OWSSB is in charge of the monitoring and maintenance of both plants.

Desludging services are based on demand and are provided by the four municipal desludging trucks. The emptying costs are 13.5 USD per trip and there is no tipping fee at the FSTP.

Designed Versus Actual Operation

Designed cycle: 31 days Designed capacity: 50 [m³/d]

	Days	Operation details
STT (1-4)	4	Loading period for two of the four STTs
	4	Settling period for two of the four STTs
UDB (5-6)	1	One loading from two STTs every 4 days
	3	Drying / resting period between two loads
	15	Drying cycle
	1	Emptying and cleaning

This cycle is repeated four times.

Operating cycle: 25 to 45 days Receiving volumes: 20 [m³/d]

	Days	Operation details
STT (1-4)	2-3	Loading period for one of the STTs
	3-4	Settling for one of the STTs before sludge transfer to the UDB
	3-5	Resting period without sludge for one of the STTs
UDB (5-6)	1	One loading of one STTs every 1-4 days
	3	Drying / resting period between two loads
	10-15	Drying cycle
	1	Emptying and cleaning
	10-15	Resting period between two loading cycles

This cycle is repeated two to three times.

Design: one cycle: 31 days

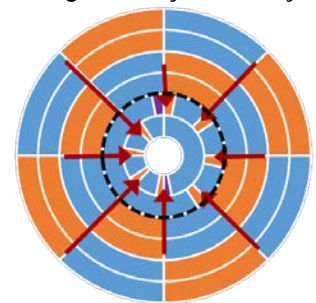

Operating: one cycle: 25-45 days

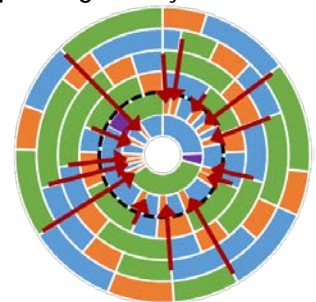

Challenges and Way Forward

A major challenge faced by the FSTP is the small quantities of sludge being discharged. A significant amount of sludge at the municipality level is dumped directly in the environment, threatening public health. Because they were initially designed for the wastewater treatment plant, the unplanted drying beds are oversized, which complicates their operation and increases sand loss. An SFD to understand where the sludge is leaving the FSM service chain is necessary to implement the best measures to increase the amount of sludge being delivered to the FSTP. To simplify their operation and minimize sand loss, the unplanted drying beds should be modified and divided in smaller units.

Scoping Study: FSTPs in SA and SSA

Eawag / Sandec October 2019

Korhogo, Ivory Coast

visited in November 2018

Background

Korhogo is the first FSTP in Ivory Coast and is located about 6 [km] north from Korhogo city centre (coordinates 9.5027697, -5.6364326). For the design and the construction, ONAD collaborated with private companies. The FSTP was implemented as a pilot for learning prior to scaling up the concept in other cities of the country. The FSTP started operation in March 2017 and was designed for a capacity of 100 [m³/d].

The treatment plant consists of 32 unplanted drying beds. The leachate is treated in two anaerobic ponds and two aerobic ponds prior to discharge in water bodies. The dried sludge is further dried on open ground and co-composting is planned but not yet implemented.

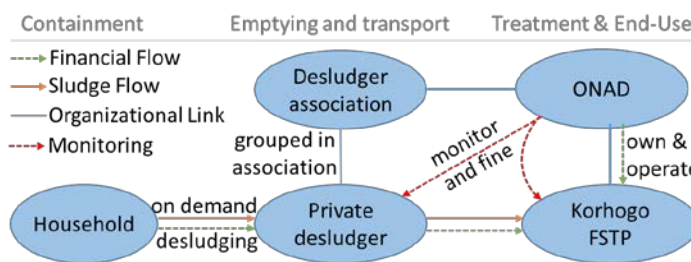
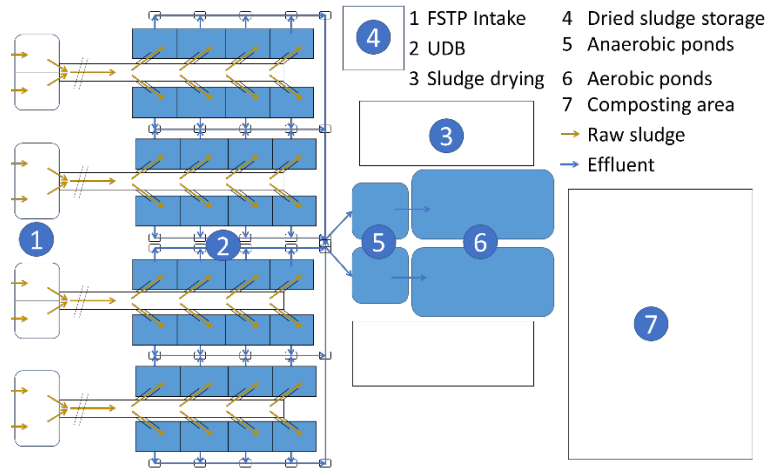

Management Scheme

ONAD owns and operates Korhogo FSTP. The collection and the transport of faecal sludge is fully managed by the private sector (mechanical emptiers). The four private service providers operating in the city are grouped in an association. The desludging model is on-demand and emptying costs are 30-60 USD per emptying, depending on volume emptied. At the FSTP, each truck has to pay a discharge fee (4 USD/truck).

Designed Versus Actual Operation

Designed cycle: 17 days Capacity: 100 [m³/d]

Days	Operation details
1	Loading of bed (100 [m ²]) with HLR: 0.45 [m]
14	Drying cycle
2	Emptying and cleaning

Operating cycle: 18 to 30 days Volumes received: 40 [m³/d]

Days	Operation details
1-2	Loading of bed with HLR: 0.6 [m] (around 10 trucks)
14-20	Drying cycle
2	Emptying and cleaning
1-5	The bed is left empty until next load

Design: one cycle: 17 days

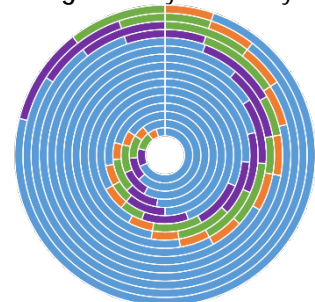

Operating: one cycle: 18-30 days

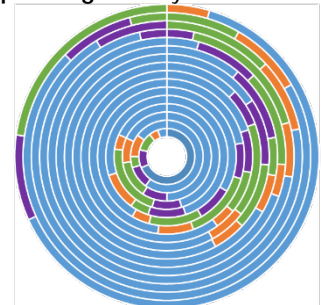

Challenges and Way Forward

One of the main challenges at the Korhogo FSTP, is that the design was for sand drying bed, but did not take into account the fact that sand is not locally available. Hence, the top layer of the drying beds is fine gravel. The result is rapid clogging of the beds, as the gravel is not fine enough to filter out solids. In addition, the dry sludge layer is thin, and the operators have to spend time to carefully scrap it away and remove the gravel, before taking it to the second drying area. There is no laboratory capacity at the FSTP, the samples have to be sent 600 [km] away to Abidjan for analysis.

A solution needs to be found for the filter media. An SFD to understand where the sludge is leaving the FSM service chain is necessary to implement the best measures to increase the amount of sludge being delivered to the FSTP. The FSTP needs monitoring capabilities; this would be a good location to trial the field laboratory.

Scoping Study: FSTPs in SA and SSA

Eawag / Sandec October 2019

Lubhu, Nepal

visited in October 2018

Background

Lubhu FSTP is located in Mahalaxmishthan municipality in the South-eastern suburb of Kathmandu (coordinates: 27.64805556, 85.37305556). BORDA funded the FSTP and designed and constructed it in collaboration with CDD society. The FSTP started operation in March 2016 and was designed for a capacity of 6 [m³/w].

The treatment consists of one feeding tank, two biogas digesters in series, a stabilisation tank and three planted drying beds. The effluent from the feeding tank, the stabilisation tank and the leachate from the drying beds are treated in one integrated settler, anaerobic baffled reactor and anaerobic filter unit and one horizontal flow constructed wetland. The dried sludge and the final effluent are used for gardening within the FSTP compound. The biogas is used for cooking by the caretaker and his family.

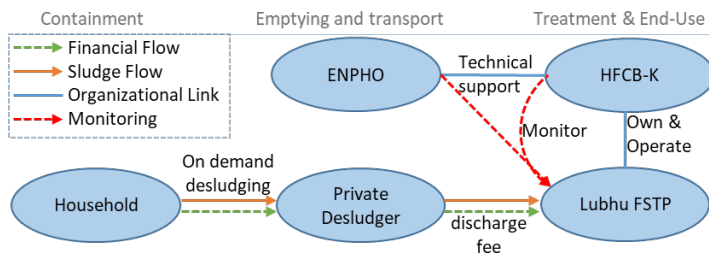
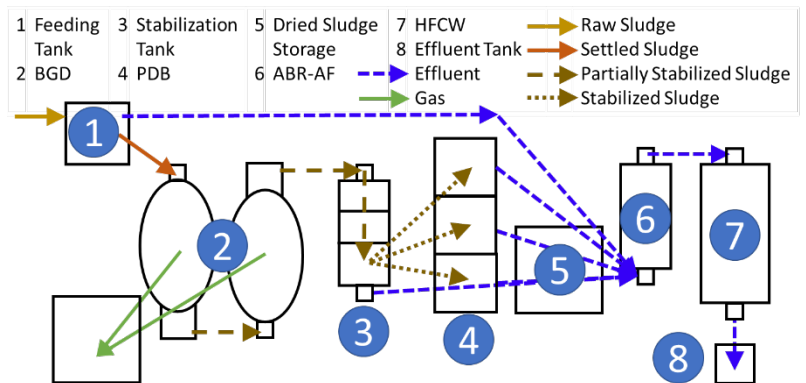

Management Scheme

Help for Children's Beilngries-Kathmandu (HFCB-K) owns the FSTP and is responsible for its operation and maintenance. The caretaker operates the plant and also monitors and manages the facility. ENPHO was providing technical supervision and supported operation, maintenance as well as sludge and effluent quality monitoring for two years. Due to lack of allocated budget, this support stopped in 2018.

Designed Versus Actual Operation

Designed cycle: 488 days

Designed capacity: 6 [m³/w]

	Days	Operation details	
FT-BGD-ST (1)	6-7	Stabilization and settling period with two loads per week	This cycle is repeated for one year
PDB (2-11)	1	Every week loading of a PDB	
	6-7	Drying period between two loads on a PDB	
	90	Drying cycle of one PDB while the other two are used	
	1	Emptying and cleaning	

Design: one cycle: 488 [days]

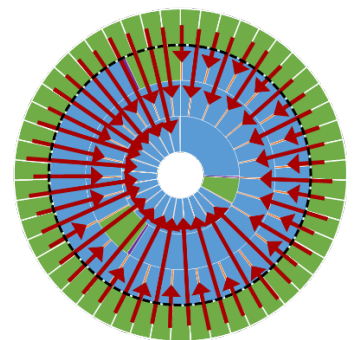

Available information was insufficient to create an operating cycle diagram

Operating cycle:

An operating cycle diagram is not available, as unfortunately, the FSTP is facing major technical issues and information was not available on the actual operating patterns of the FSTP. The FSTP is receiving about 6 [m³/w] of faecal sludge, but the stabilization tank is clogged, the plants in the drying beds have died, and the drying beds are also clogged. The beds are loaded until full, and then the sludge is left to settle and evaporate. When the bed is needed again, it is emptied and the sludge is transferred to a storage area where it further dries.

Challenges and Way Forward

In addition to the technical issues mentioned above, the caretaker and Help for Children's Beilngries-Kathmandu do not have the necessary capacities in terms of human resources, finance, knowledge and technical skills to operate and maintain the FSTP without the support from ENPHO.

The best options to repair the FSTP need to be evaluated, funded and implemented. Potential solutions include the replacement of the stabilization tank by a more standard settling tank, the emptying and cleaning of the filter media in the drying beds, and the installation of a volumetric measurement in the feeding tank. In addition, a detailed operation, maintenance, management and business plan should be developed so that the owner and the caretaker can sustainably operate the FSTP.

FSTP in SA and SSA: a scoping study

Eawag / Sandec October 2019

Tivaouane Peulh, Senegal

visited in November 2018

Background

Tivaouane Peulh FSTP is located 7 [km] north-east from Dakar city, in the most eastern part of the Rufisque section of Dakar (coordinates: 14.825690, -17.293410). It was funded by a grant allocated by the BMGF as part of the program for restructuring of faecal sludge markets in the suburbs of Dakar. ONAS was responsible for the design and construction. The FSTP started operation in September 2017 and was designed for a capacity of 400 [m³/d]. It is the most recent of the four existing FSTPs in Dakar (60% coverage by onsite sanitation, 40% sewer coverage).

The treatment consists of two parallel settling thickening tanks and 30 unplanted drying beds. The leachate from the drying beds and the effluent from the settling thickening tanks flow to the effluent holding tank before being pumped to the neighbouring wastewater treatment plant. The dried sludge is stored in the storage shed before being sold to farmers. The scum produced by the settling thickening tanks is co-composted with grass.

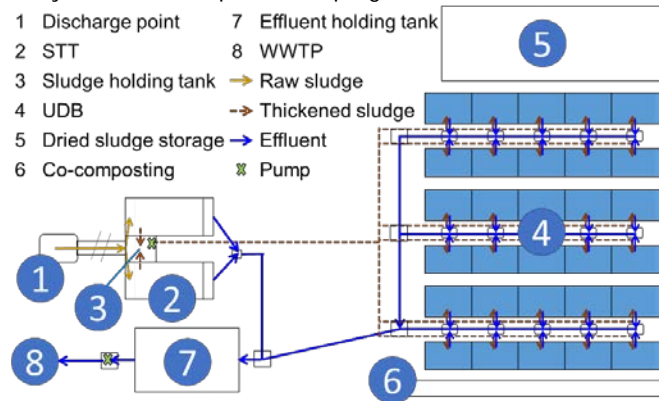

Management Scheme

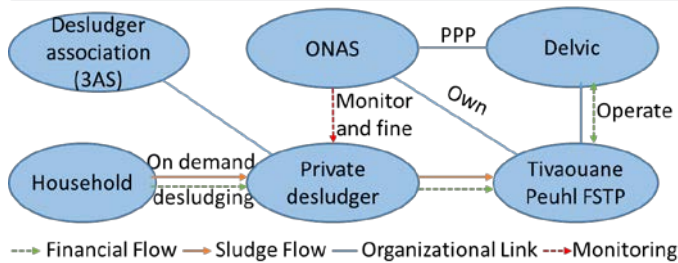

ONAS owns the FSTP and delegates its operation through a PPP to Delvic Sanitation Initiatives, who is also operating the three other FSTPs in Dakar.

The desludging services are entirely covered by the private sector. The households directly call the truck drivers when desludging is needed. The service providers have an emptiers association. At the FSTP, the truck drivers must pay a discharge fee based on the volume of sludge discharged (0.6 USD/ m³).

Designed Versus Actual Operation

Designed cycle: 30 to 40 days

Designed capacity: 400 [m³/d]

	Days	Operation details
STT (1-2)	3-4	Loading period for one of the two STT
	3-4	Settling period for one of the two STT
UDB (3-17)	1	Loading (pumping from SHT) of one bed with 0.5 [m] sludge.
	21-30	Drying cycle
	1	Emptying and cleaning

Design: one cycle: 30-40 days

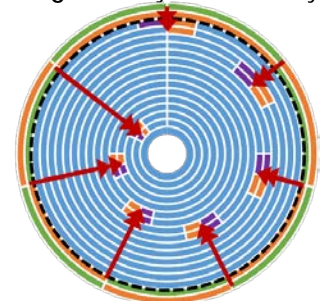

Operating cycle: about 32 to 45 days

Receiving volumes: 200 [m³/d]

	Days	Operation details
STT (1-2)	2-4	Continuous loading period for both STT every 2 to 4 days, the sludge is emptied into the SHT
	1	Loading (pumping from SHT) of one bed with 0.6 [m] sludge.
UDB (3-17)	21-28	Drying cycle
	1	Emptying and cleaning
	7-14	Resting period (three beds are not used)

Operating: one cycle: 32-45 days

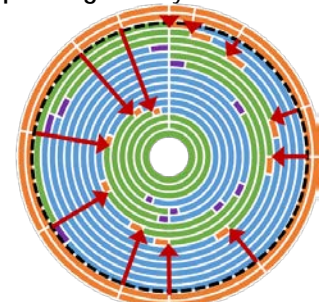

Challenges and Preliminary Suggestions

Based on Delvic's experience, the operation of the settling thickening tanks has been modified to operate in parallel without a settling period, instead of alternating. Operational challenges include solid waste mixed with sludge, and removing sand that accumulates in the sludge holding tank. This highlights the need of adaptive operations and management at the FSTP level. This FSTP was designed to be larger than the other three in Dakar, but as it becomes over-loaded, operational challenges will need to be addressed.

Scoping Study: FSTPs in SA and SSA

Eawag / Sandec October 2019

Cambérène, Senegal

visited in November 2018

Background

Cambérène FSTP is located in Dakar around 7 [km] northeast from Dakar city centre (coordinates: 14.746167, -17.425278). It was funded by ONAS through a loan allocated by the World Bank. ONAS was responsible for the design and construction. The FSTP started operation in 2006 and was designed for a capacity of 100 [m³/d].

The treatment consists of two parallel settling thickening tanks and 10 unplanted drying beds. The effluent from the settling thickening tanks flows to the effluent holding tank before being pumped to the neighbouring wastewater treatment plant (activated sludge). The dried sludge is stored in the storage shed before being sold to farmers. The scum produced by the settling thickening tanks is co-composted with solid wastes.

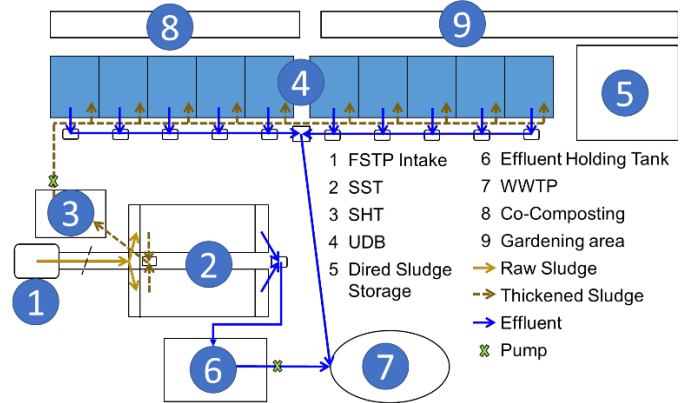

Management Scheme

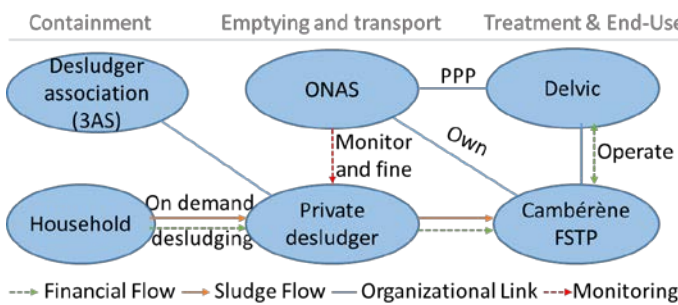

ONAS owns the FSTP and delegates its operation through a PPP to Delvic Sanitation Initiatives, who is also operating the three other FSTPs in Dakar.

The desludging services are entirely covered by the private sector. The households directly call the truck drivers when desludging is needed. The service providers have an emptiers association. At the FSTP, the truck drivers must pay a discharge fee based on the volume of sludge discharged (0.6 USD/ m³).

Designed Versus Actual Operation

Designed cycle: 32 to 42 days Capacity: 100 [m³/d]

	Days	Operation details
STT (1-2)	3-4	Loading period for one of the two STT
	3-4	Settling period for one of the two STT
UDB (3-12)	1	Loading (pumping form SHT) of one bed (16x8 [m])
	21-28	Drying cycle
	1	Emptying and cleaning
	2-5	The bed is left empty until next load

Operating cycle: 26 to 36 days Capacity: 500-600 [m³/d]

	Days	Operation details
STT (1)	2-3	Continuous loading, every 2 - 3 days sludge is emptied in the SHT
UDB (3-10)	1	Loading (pumping form SHT) of one bed
	1	After overnight settling, the liquid supernatant is siphoned out
	21-30	Drying cycle
	1	Emptying and cleaning

Challenges Preliminary Suggestions

Cambérène FSTP is operating at more than six times over capacity, resulting in solids concentration in the effluent that disrupt the subsequent wastewater treatment plant. In response, Delvic is implementing some modifications to increase the capacity of the FSTP, such as modification of use of the settling thickening tanks from parallel to in series, and implementation of a flocculation unit. However, even with modifications, it is not possible for a FSTP to effectively treat six times its original designed capacity. The modifications also have other impacts on the FSTP, such as overloading of the drying beds due to increase sludge production. Overloading also results in significant sand accumulation in the first settling thickening tank. Delvic is also researching the possibility of using mechanical dewatering, and solutions such as a grit chamber for the sand accumulation in the settling thickening tank. Solid waste management is also a significant operational challenge.

Dakar is in need of a Q&Q study to understand the total amount of faecal sludge that needs to be treated, followed by a sanitation master plan, and investments in new infrastructure.

Design: one cycle: 32-42 days

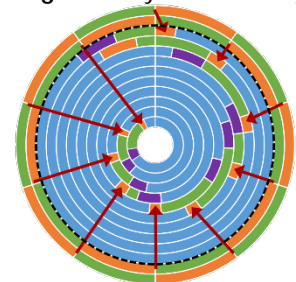

Operating: one cycle: 25-35 days

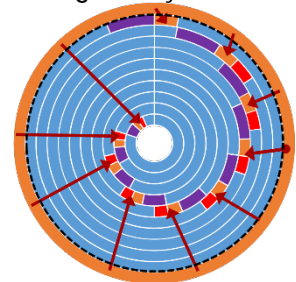

FSTP in SA and SSA: a scoping study

Eawag / Sandec October 2019

Niayes, Senegal

Background

Niayes FSTP is located in a dense urban area about 11 [km] northeast of Dakar city centre (coordinates: 14.760179, -17.403968). ONAS was responsible for design and construction of the FSTP, which was funded through a loan from the World Bank. It is one of the four FSTPs present in Dakar (60% coverage by onsite sanitation, 40% sewer coverage). The FSTP started operation in 2008 and was designed for a capacity of 60 [m³/d].

The treatment consists of two settling thickening tanks in series, two anaerobic tanks, a flocculation unit and 10 unplanted drying beds. The leachate from the settling thickening tanks flows to the anaerobic tank, and is then pumped to the flocculation unit. The effluent of the flocculation unit and the leachate from the drying beds are then pumped to the neighbouring wastewater treatment plant. The dried sludge is stored in a storage shed before being used by the Omniprocessor. The scum produced by the settling thickening tanks is co-composted with grass.

visited in November 2018

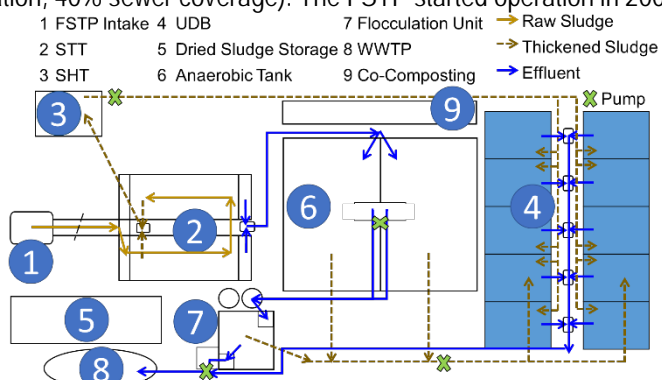

Management Scheme

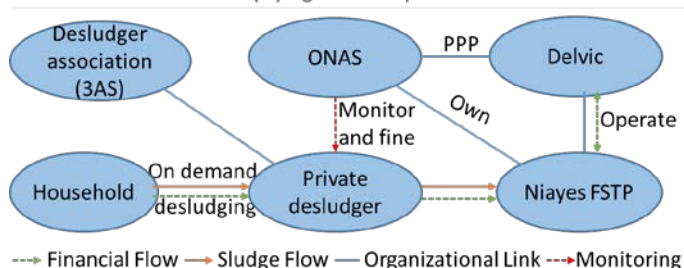

ONAS owns the FSTP and has delegated its operation through a PPP to Delvic Sanitation Initiatives, who is also operating the three other FSTP of Dakar.

The desludging services are entirely covered by the private sector. The households directly call the truck drivers when desludging is needed. The service providers have an emptiers association. At the FSTP, the truck drivers must pay a discharge fee based on the volume of sludge discharged (0.6 USD/ m³).

Designed Versus Actual Operation

Designed cycle: 30 to 37 days Capacity: 60 [m³/d]

Days	Operation details
STT (1-2)	3-4 Loading period for one of the two STT
	3-4 Settling period for one of the two STT
UDB (3-12)	1 Loading (pumping from SHT) of beds
	21-28 Drying cycle
	1 Emptying and cleaning

Operating cycle: 23 to 33 days Capacity: 400-500 [m³/d]

Days	Operation details
STT	2-3 Continuous loading period (STT function in Series)
Floc	0.5 Morning and evening pumping on the beds
UDB	1 Loading (pumping from SHT and flocculation) of beds (HLR 0.6 [m]).
	1 After settling overnight settling, the liquid supernatant is siphoned out
	21-30 Drying cycle
	1 Emptying and cleaning

Design: one cycle 30-37 days

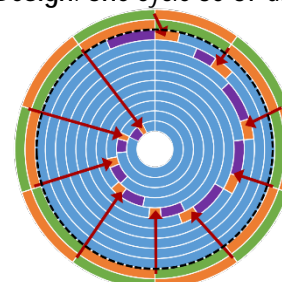

Operating cycle:

Due to major changes in the treatment infrastructure, an operating cycle diagram was not constructed. The implemented changes have also increased significantly the amount of sludge produced, which led to an overloading of the drying beds.

Challenges Preliminary Suggestions

Niayes FSTP is operating at more than six times over capacity, resulting in solids concentration in the effluent that disrupt the subsequent wastewater treatment plant. In response, Delvic is implementing some modifications to increase the capacity of the FSTP, such as modification of use of the settling thickening tanks from parallel to in series, and implementation of a flocculation unit. However, even with modifications, it is not possible for a FSTP to effectively treat six times its original designed capacity. The modifications also have other impacts on the FSTP, such as overloading of the drying beds due to increase sludge production. Overloading also results in significant sand accumulation in the first settling thickening tank. Delvic is also researching the possibility of using mechanical dewatering, and solutions such as a grit chamber for the sand accumulation in the settling thickening tank. Solid waste management is also a significant operational challenge.

Dakar is in need of a Q&Q study to understand the total amount of faecal sludge that needs to be treated, followed by a sanitation master plan, and investments in new infrastructure.

Rufisque, Senegal

Background

visited in November 2018

Rufisque faecal sludge treatment plant (FSTP) is located in a semi-industrial residential area 25 [km] southeast of Dakar city (coordinates: 14.721414, -17.294738). ONAS was responsible for design and construction of the FSTP, which was funded through a loan from the World Bank. It is one of the four FSTPs present in Dakar (60% coverage by onsite sanitation, 40% sewer coverage). The FSTP started operation in 2008 and was designed for a capacity of 60 [m³/d].

The treatment consists of two settling thickening tanks in series, a flocculation unit and nine unplanted drying beds. The effluent from the flocculation unit and the leachate from the drying beds flow to the neighbouring wastewater treatment plant (WSPs). The dried sludge is stored in the storage shed before being sold to farmers. The scum produced by the settling thickening tanks is co-composted with grass.

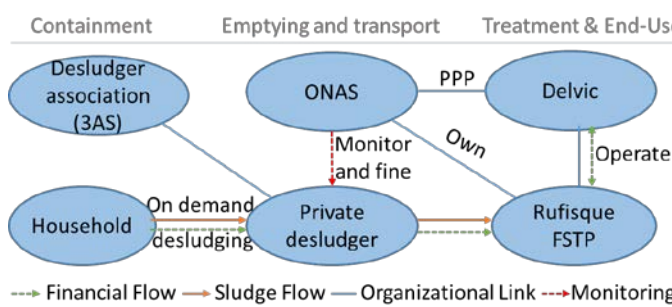
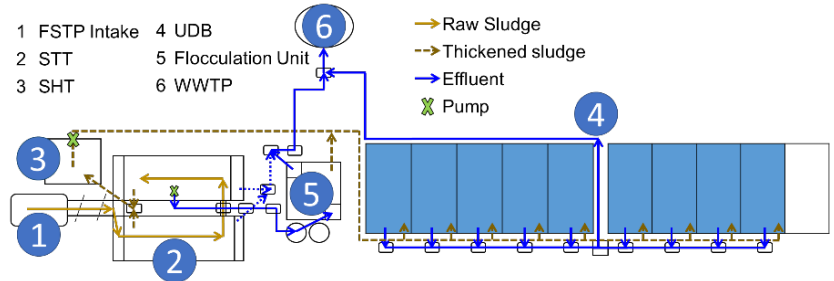

Management Scheme

ONAS owns the FSTP and has delegated its operation through a PPP to Delvic Sanitation Initiatives, who is also operating the three other FSTP of Dakar.

The desludging services are entirely covered by the private sector. The households directly call the truck drivers when desludging is needed. The service providers have an emptiers association. At the FSTP, the truck drivers must pay a discharge fee based on the volume of sludge discharged (0.6 USD/ m³).

Designed Versus Actual Operation

Designed cycle: 37 to 44 days Capacity: 60 [m³/d]

	Days	Operation details
STT	3 - 4	Loading period for one of the two STT
	3 - 4	Settling period for one of the two STT
UDB	1	Loading (pumping from SHT) of beds (10x6.5 [m])
	21 - 28	Drying cycle
	1	Emptying and cleaning

Operating cycle: 23 to 33 days Capacity: 500-600 [m³/d]

	Days	Operation details
STT	2-3	Continuous loading period (STT functioning in Series)
Floc	0.5	Morning and evening pumping on the beds
UDB	1	Loading (pumping from SHT and flocculation) of beds (HLR 0.6 [m]).
	21 - 30	Drying cycle
	1	After settling overnight settling, the liquid supernatant is siphoned out
	1	Emptying and cleaning

Design: one cycle 37-44 days

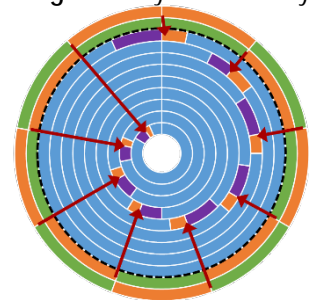

Operating cycle:

Due to major changes in the treatment infrastructure, an operating cycle diagram was not constructed. The implemented changes have also increased significantly the amount of sludge produced, which led to an overloading of the drying beds.

Challenges Preliminary Suggestions

Rufisque FSTP is operating at more than six times over capacity, resulting in solids concentration in the effluent that disrupt the subsequent wastewater treatment plant. In response, Delvic is implementing some modifications to increase the capacity of the FSTP, such as modification of use of the settling thickening tanks from parallel to in series, and implementation of a flocculation unit. However, even with modifications, it is not possible for a FSTP to effectively treat six times its original designed capacity. The modifications also have other impacts on the FSTP, such as overloading of the drying beds due to increase sludge production. Overloading also results in significant sand accumulation in the first settling thickening tank. Delvic is also researching the possibility of using mechanical dewatering, and solutions such as a grit chamber for the sand accumulation in the settling thickening tank. Solid waste management is also a significant operational challenge.

Dakar is in need of a Q&Q study to understand the total amount of faecal sludge that needs to be treated, followed by a sanitation master plan, and investments in new infrastructure.

FSTP in SA and SSA: a scoping study

Eawag / Sandec October 2019

Chazanga, Zambia

visited in December 2018

Background

Chazanga FSTP is located in Chazanga, a densely populated neighbourhood in the north of Lusaka (coordinates: 15.340791, 28.289216). In Lusaka, there is also the Kanyama FSTP (same process flow, but no drying beds), and Manchinchi WWTP receiving faecal sludge. Chazanga FSTP was funded by the Stone Family Foundation. BORDA designed it and WSUP supervised the construction. It started operation in February 2013 and was designed to receive 4 [m³/d].

The treatment consists of one bio-digester connected to a sludge holding tank. The digested sludge is then dewatered on six unplanted drying beds. The dried sludge is stored in a storage shed. The effluent from the biodigester is further treated in a secondary settling tank, a gravel filter and a polishing pond before flowing into a soak away pit. The leachate from the drying beds flows directly to the soak away pit.

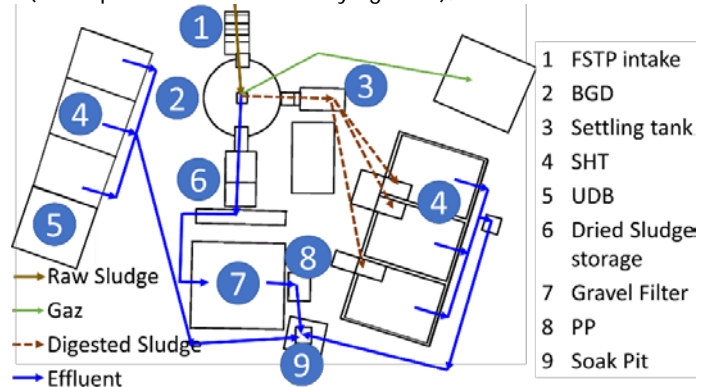

Management Scheme

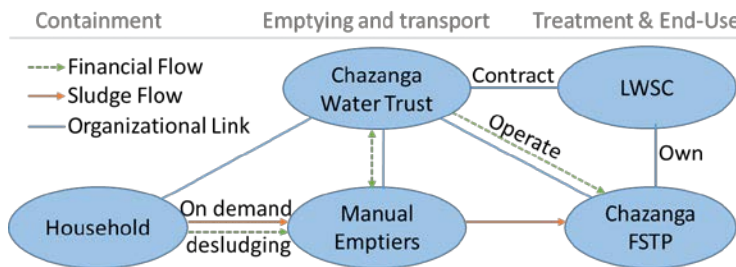

LWSC owns the FSTP and delegates its operation to Chazanga Water Trust, who is also in charge of sludge collection services.

The desludging services are mainly on demand, manual emptying. The households call the Chazanga Water Trust, and they send their emptying team. The emptiers take 60% of the desludging tariff as salary and the rest is used for maintenance. The emptying fees are 30, 39 and 46 USD for 720, 1440 and 1920 L respectively.

Designed Versus Actual Operation

Designed cycle: 36 days Designed Capacity: 4 [m³/d]

	Days	Operation details
BGD (1)	5-7	Continuous loading of the digester and transfer of sludge to the SHT.
	1	Sludge from SHT is loaded onto one drying bed (HLR: 0.15 [m])
UDB (2-7)	30	Drying cycle
	1	Emptying and cleaning
	4	Resting / buffer period

Design: one cycle: 36 days

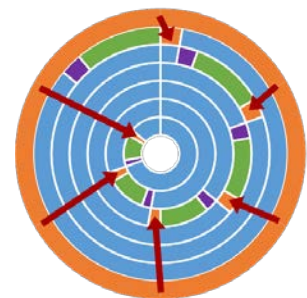

Operating cycle: 17 – 32 days Receiving volumes: 5-7 [m³/d]

	Days	Operation details
BGD (1)	-	Continuous loading of the digester and transfer of sludge to the SHT.
UDB (2-7)	1	As soon as one is emptied, the sludge is loaded on a drying bed (HLR: 0.1 to 0.2 [m]).
	15-30	Drying cycle, depending on weather conditions and HLR
	1	Emptying and cleaning

Operating: one cycle: 17-32 days

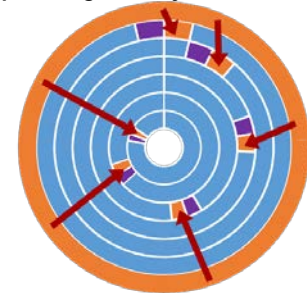

Challenges and Preliminary Suggestions

The FSTP is overloaded and the current operating scheme cannot cope with the overloading. A team of manual emptiers are operating the FSTP. The emptiers do not have adequate capacity for adaptive management or daily operation of the FSTPs. For example, they do not like to use the grit chamber because they find it a hassle, but the result is that the anaerobic digester becomes clogged, resulting in a shut down of approximately one month every three months while the piping and digester are manually cleared out. This highlights the need of dedicated and skilled staff, and guidelines for adaptive operation and management.

Capacity is currently being expanded at Chazanga and Kanyama, but even more capacity is needed. There should be a designated operator at the FSTP, and a closely monitored optimization of the operation and management of the FSTP should be implemented. Shortly after the field visit, the FSTP was shut down due to concerns with Cholera. There are plans to reactivate it in the future.

Scoping Study: FSTPs in SA and SSA

Eawag / Sandec October 2019

Supplemental Information

- I. Results from Scoping study: 120+ list of FSTPs
 - a. South Asia list
 - b. Sub-Saharan Africa list
- II. FSTP Field Visit Reports
 - Bangladesh
 - a. Jhenaidah
 - b. Faridpur
 - c. Khulna
 - d. Kushtia
 - e. Sakhipur
 - Burkina Faso
 - f. Sourgoubila
 - g. Kossodo
 - h. Zajtoui
 - India
 - i. Bhubaneswar
 - j. Karunguzhi
 - k. Devanahalli
 - l. Puri
 - m. Dhenkanal
 - n. Brahmapur
 - Ivory Coast
 - o. Khorogo
 - Malawi
 - p. Zingwangwa, Chirimba, Limbe
 - Nepal
 - q. Gulariya
 - r. Lubhu
 - Senegal
 - s. Tivaouane Peulh
 - t. Camberene
 - u. Niaye
 - v. Rufisque
 - Zambia
 - w. Chazanga, Kanyama, Manchinchi